

R&S® SMF100A

Microwave Signal Generator

Operating Manual



1167.2319.32 – 07

This document describes the R&S®SMF100A, stock no. 1167.0000.02 and its options.

- R&S®SMF-B1
- R&S®SMF-B2
- R&S®SMF-B20
- R&S®SMF-B22
- R&S®SMF-B26
- R&S®SMF-B27
- R&S®SMF-B32/34
- R&S®SMF-B81/B82
- R&S®SMF-B83/84/85
- R&S®SMF-B122/144
- R&S®SMF-K3
- R&S®SMF-K4
- R&S®SMF-K23
- R&S®SMF-K27
- R&S®SMF-K28

The firmware of the instrument makes use of the operating system LINUX® and other valuable open source software packages. The most important of them together with their corresponding open source license and the verbatim license texts are provided on the user documentation CD-ROM (included in delivery).

The OpenSSL Project for use in the OpenSSL Toolkit (<http://www.openssl.org/>) includes cryptographic software written by Eric Young (eay@cryptsoft.com) and software written by Tim Hudson (tjh@cryptsoft.com). LINUX® is a trademark of Linus Torvalds.

Rohde & Schwarz would like to thank the open source community for their valuable contribution to embedded computing.

© 2011 Rohde & Schwarz GmbH & Co. KG

Muehldorfstr. 15, 81671 Munich, Germany

Phone: +49 89 41 29 - 0

Fax: +49 89 41 29 12 164

E-mail: info@rohde-schwarz.com

Internet: <http://www.rohde-schwarz.com>

Subject to change – Data without tolerance limits is not binding.

R&S® is a registered trademark of Rohde & Schwarz GmbH & Co. KG.

Trade names are trademarks of the owners.

The following abbreviations are used throughout this manual: R&S®SMF100A is abbreviated as R&S SMF, and the R&S®SMZ75/90/110 is abbreviated as R&S®SMZ.

Basic Safety Instructions

Always read through and comply with the following safety instructions!

All plants and locations of the Rohde & Schwarz group of companies make every effort to keep the safety standards of our products up to date and to offer our customers the highest possible degree of safety. Our products and the auxiliary equipment they require are designed, built and tested in accordance with the safety standards that apply in each case. Compliance with these standards is continuously monitored by our quality assurance system. The product described here has been designed, built and tested in accordance with the attached EC Certificate of Conformity and has left the manufacturer's plant in a condition fully complying with safety standards. To maintain this condition and to ensure safe operation, you must observe all instructions and warnings provided in this manual. If you have any questions regarding these safety instructions, the Rohde & Schwarz group of companies will be happy to answer them.

Furthermore, it is your responsibility to use the product in an appropriate manner. This product is designed for use solely in industrial and laboratory environments or, if expressly permitted, also in the field and must not be used in any way that may cause personal injury or property damage. You are responsible if the product is used for any intention other than its designated purpose or in disregard of the manufacturer's instructions. The manufacturer shall assume no responsibility for such use of the product.

The product is used for its designated purpose if it is used in accordance with its product documentation and within its performance limits (see data sheet, documentation, the following safety instructions). Using the product requires technical skills and a basic knowledge of English. It is therefore essential that only skilled and specialized staff or thoroughly trained personnel with the required skills be allowed to use the product. If personal safety gear is required for using Rohde & Schwarz products, this will be indicated at the appropriate place in the product documentation. Keep the basic safety instructions and the product documentation in a safe place and pass them on to the subsequent users.

Observing the safety instructions will help prevent personal injury or damage of any kind caused by dangerous situations. Therefore, carefully read through and adhere to the following safety instructions before and when using the product. It is also absolutely essential to observe the additional safety instructions on personal safety, for example, that appear in relevant parts of the product documentation. In these safety instructions, the word "product" refers to all merchandise sold and distributed by the Rohde & Schwarz group of companies, including instruments, systems and all accessories.

Symbols and safety labels

							
Notice, general danger location Observe product documentation	Caution when handling heavy equipment	Danger of electric shock	Warning! Hot surface	PE terminal	Ground	Ground terminal	Be careful when handling electrostatic sensitive devices

					
ON/OFF supply voltage	Standby indication	Direct current (DC)	Alternating current (AC)	Direct/alternating current (DC/AC)	Device fully protected by double (reinforced) insulation

Tags and their meaning

The following signal words are used in the product documentation in order to warn the reader about risks and dangers.

	indicates a hazardous situation which, if not avoided, will result in death or serious injury.
	indicates a hazardous situation which, if not avoided, could result in death or serious injury.
	indicates a hazardous situation which, if not avoided, could result in minor or moderate injury.
	indicates the possibility of incorrect operation which can result in damage to the product. In the product documentation, the word ATTENTION is used synonymously.

These tags are in accordance with the standard definition for civil applications in the European Economic Area. Definitions that deviate from the standard definition may also exist in other economic areas or military applications. It is therefore essential to make sure that the tags described here are always used only in connection with the related product documentation and the related product. The use of tags in connection with unrelated products or documentation can result in misinterpretation and in personal injury or material damage.

Operating states and operating positions

The product may be operated only under the operating conditions and in the positions specified by the manufacturer, without the product's ventilation being obstructed. If the manufacturer's specifications are not observed, this can result in electric shock, fire and/or serious personal injury or death. Applicable local or national safety regulations and rules for the prevention of accidents must be observed in all work performed.

1. Unless otherwise specified, the following requirements apply to Rohde & Schwarz products: predefined operating position is always with the housing floor facing down, IP protection 2X, pollution severity 2, overvoltage category 2, use only indoors, max. operating altitude 2000 m above sea level, max. transport altitude 4500 m above sea level. A tolerance of $\pm 10\%$ shall apply to the nominal voltage and $\pm 5\%$ to the nominal frequency.
2. Do not place the product on surfaces, vehicles, cabinets or tables that for reasons of weight or stability are unsuitable for this purpose. Always follow the manufacturer's installation instructions when installing the product and fastening it to objects or structures (e.g. walls and shelves). An installation that is not carried out as described in the product documentation could result in personal injury or death.
3. Do not place the product on heat-generating devices such as radiators or fan heaters. The ambient temperature must not exceed the maximum temperature specified in the product documentation or in the data sheet. Product overheating can cause electric shock, fire and/or serious personal injury or death.

Electrical safety

If the information on electrical safety is not observed either at all to the extent necessary, electric shock, fire and/or serious personal injury or death may occur.

1. Prior to switching on the product, always ensure that the nominal voltage setting on the product matches the nominal voltage of the AC supply network. If a different voltage is to be set, the power fuse of the product may have to be changed accordingly.
2. In the case of products of safety class I with movable power cord and connector, operation is permitted only on sockets with an earthing contact and protective earth connection.
3. Intentionally breaking the protective earth connection either in the feed line or in the product itself is not permitted. Doing so can result in the danger of an electric shock from the product. If extension cords or connector strips are implemented, they must be checked on a regular basis to ensure that they are safe to use.
4. If the product does not have a power switch for disconnection from the AC supply network, the plug of the connecting cable is regarded as the disconnecting device. In such cases, always ensure that the power plug is easily reachable and accessible at all times (corresponding to the length of connecting cable, approx. 2 m). Functional or electronic switches are not suitable for providing disconnection from the AC supply network. If products without power switches are integrated into racks or systems, a disconnecting device must be provided at the system level.
5. Never use the product if the power cable is damaged. Check the power cable on a regular basis to ensure that it is in proper operating condition. By taking appropriate safety measures and carefully laying the power cable, you can ensure that the cable will not be damaged and that no one can be hurt by, for example, tripping over the cable or suffering an electric shock.
6. The product may be operated only from TN/TT supply networks fused with max. 16 A (higher fuse only after consulting with the Rohde & Schwarz group of companies).
7. Do not insert the plug into sockets that are dusty or dirty. Insert the plug firmly and all the way into the socket. Otherwise, sparks that result in fire and/or injuries may occur.
8. Do not overload any sockets, extension cords or connector strips; doing so can cause fire or electric shocks.
9. For measurements in circuits with voltages $V_{\text{rms}} > 30 \text{ V}$, suitable measures (e.g. appropriate measuring equipment, fusing, current limiting, electrical separation, insulation) should be taken to avoid any hazards.
10. Ensure that the connections with information technology equipment, e.g. PCs or other industrial computers, comply with the IEC60950-1/EN60950-1 or IEC61010-1/EN 61010-1 standards that apply in each case.
11. Unless expressly permitted, never remove the cover or any part of the housing while the product is in operation. Doing so will expose circuits and components and can lead to injuries, fire or damage to the product.
12. If a product is to be permanently installed, the connection between the PE terminal on site and the product's PE conductor must be made first before any other connection is made. The product may be installed and connected only by a licensed electrician.
13. For permanently installed equipment without built-in fuses, circuit breakers or similar protective devices, the supply circuit must be fused in such a way that anyone who has access to the product, as well as the product itself, is adequately protected from injury or damage.

Basic Safety Instructions

14. Use suitable overvoltage protection to ensure that no overvoltage (such as that caused by a bolt of lightning) can reach the product. Otherwise, the person operating the product will be exposed to the danger of an electric shock.
15. Any object that is not designed to be placed in the openings of the housing must not be used for this purpose. Doing so can cause short circuits inside the product and/or electric shocks, fire or injuries.
16. Unless specified otherwise, products are not liquid-proof (see also section "Operating states and operating positions", item 1. Therefore, the equipment must be protected against penetration by liquids. If the necessary precautions are not taken, the user may suffer electric shock or the product itself may be damaged, which can also lead to personal injury.
17. Never use the product under conditions in which condensation has formed or can form in or on the product, e.g. if the product has been moved from a cold to a warm environment. Penetration by water increases the risk of electric shock.
18. Prior to cleaning the product, disconnect it completely from the power supply (e.g. AC supply network or battery). Use a soft, non-linting cloth to clean the product. Never use chemical cleaning agents such as alcohol, acetone or diluents for cellulose lacquers.

Operation

1. Operating the products requires special training and intense concentration. Make sure that persons who use the products are physically, mentally and emotionally fit enough to do so; otherwise, injuries or material damage may occur. It is the responsibility of the employer/operator to select suitable personnel for operating the products.
2. Before you move or transport the product, read and observe the section titled "Transport".
3. As with all industrially manufactured goods, the use of substances that induce an allergic reaction (allergens) such as nickel cannot be generally excluded. If you develop an allergic reaction (such as a skin rash, frequent sneezing, red eyes or respiratory difficulties) when using a Rohde & Schwarz product, consult a physician immediately to determine the cause and to prevent health problems or stress.
4. Before you start processing the product mechanically and/or thermally, or before you take it apart, be sure to read and pay special attention to the section titled "Waste disposal", item 1.
5. Depending on the function, certain products such as RF radio equipment can produce an elevated level of electromagnetic radiation. Considering that unborn babies require increased protection, pregnant women must be protected by appropriate measures. Persons with pacemakers may also be exposed to risks from electromagnetic radiation. The employer/operator must evaluate workplaces where there is a special risk of exposure to radiation and, if necessary, take measures to avert the potential danger.
6. Should a fire occur, the product may release hazardous substances (gases, fluids, etc.) that can cause health problems. Therefore, suitable measures must be taken, e.g. protective masks and protective clothing must be worn.
7. If a laser product (e.g. a CD/DVD drive) is integrated into a Rohde & Schwarz product, absolutely no other settings or functions may be used as described in the product documentation. The objective is to prevent personal injury (e.g. due to laser beams).

Repair and service

1. The product may be opened only by authorized, specially trained personnel. Before any work is performed on the product or before the product is opened, it must be disconnected from the AC supply network. Otherwise, personnel will be exposed to the risk of an electric shock.
2. Adjustments, replacement of parts, maintenance and repair may be performed only by electrical experts authorized by Rohde & Schwarz. Only original parts may be used for replacing parts relevant to safety (e.g. power switches, power transformers, fuses). A safety test must always be performed after parts relevant to safety have been replaced (visual inspection, PE conductor test, insulation resistance measurement, leakage current measurement, functional test). This helps ensure the continued safety of the product.

Batteries and rechargeable batteries/cells

If the information regarding batteries and rechargeable batteries/cells is not observed either at all or to the extent necessary, product users may be exposed to the risk of explosions, fire and/or serious personal injury, and, in some cases, death. Batteries and rechargeable batteries with alkaline electrolytes (e.g. lithium cells) must be handled in accordance with the EN 62133 standard.

1. Cells must not be taken apart or crushed.
2. Cells or batteries must not be exposed to heat or fire. Storage in direct sunlight must be avoided. Keep cells and batteries clean and dry. Clean soiled connectors using a dry, clean cloth.
3. Cells or batteries must not be short-circuited. Cells or batteries must not be stored in a box or in a drawer where they can short-circuit each other, or where they can be short-circuited by other conductive materials. Cells and batteries must not be removed from their original packaging until they are ready to be used.
4. Keep cells and batteries out of the hands of children. If a cell or a battery has been swallowed, seek medical aid immediately.
5. Cells and batteries must not be exposed to any mechanical shocks that are stronger than permitted.
6. If a cell develops a leak, the fluid must not be allowed to come into contact with the skin or eyes. If contact occurs, wash the affected area with plenty of water and seek medical aid.
7. Improperly replacing or charging cells or batteries that contain alkaline electrolytes (e.g. lithium cells) can cause explosions. Replace cells or batteries only with the matching Rohde & Schwarz type (see parts list) in order to ensure the safety of the product.
8. Cells and batteries must be recycled and kept separate from residual waste. Rechargeable batteries and normal batteries that contain lead, mercury or cadmium are hazardous waste. Observe the national regulations regarding waste disposal and recycling.

Transport

1. The product may be very heavy. Therefore, the product must be handled with care. In some cases, the user may require a suitable means of lifting or moving the product (e.g. with a lift-truck) to avoid back or other physical injuries.

2. Handles on the products are designed exclusively to enable personnel to transport the product. It is therefore not permissible to use handles to fasten the product to or on transport equipment such as cranes, fork lifts, wagons, etc. The user is responsible for securely fastening the products to or on the means of transport or lifting. Observe the safety regulations of the manufacturer of the means of transport or lifting. Noncompliance can result in personal injury or material damage.
3. If you use the product in a vehicle, it is the sole responsibility of the driver to drive the vehicle safely and properly. The manufacturer assumes no responsibility for accidents or collisions. Never use the product in a moving vehicle if doing so could distract the driver of the vehicle. Adequately secure the product in the vehicle to prevent injuries or other damage in the event of an accident.

Waste disposal

1. If products or their components are mechanically and/or thermally processed in a manner that goes beyond their intended use, hazardous substances (heavy-metal dust such as lead, beryllium, nickel) may be released. For this reason, the product may only be disassembled by specially trained personnel. Improper disassembly may be hazardous to your health. National waste disposal regulations must be observed.
2. If handling the product releases hazardous substances or fuels that must be disposed of in a special way, e.g. coolants or engine oils that must be replenished regularly, the safety instructions of the manufacturer of the hazardous substances or fuels and the applicable regional waste disposal regulations must be observed. Also observe the relevant safety instructions in the product documentation. The improper disposal of hazardous substances or fuels can cause health problems and lead to environmental damage.

Informaciones elementales de seguridad

Es imprescindible leer y observar las siguientes instrucciones e informaciones de seguridad!

El principio del grupo de empresas Rohde & Schwarz consiste en tener nuestros productos siempre al día con los estándares de seguridad y de ofrecer a nuestros clientes el máximo grado de seguridad. Nuestros productos y todos los equipos adicionales son siempre fabricados y examinados según las normas de seguridad vigentes. Nuestro sistema de garantía de calidad controla constantemente que sean cumplidas estas normas. El presente producto ha sido fabricado y examinado según el certificado de conformidad adjunto de la UE y ha salido de nuestra planta en estado impecable según los estándares técnicos de seguridad. Para poder preservar este estado y garantizar un funcionamiento libre de peligros, el usuario deberá atenerse a todas las indicaciones, informaciones de seguridad y notas de alerta. El grupo de empresas Rohde & Schwarz está siempre a su disposición en caso de que tengan preguntas referentes a estas informaciones de seguridad.

Además queda en la responsabilidad del usuario utilizar el producto en la forma debida. Este producto está destinado exclusivamente al uso en la industria y el laboratorio o, si ha sido expresamente autorizado, para aplicaciones de campo y de ninguna manera deberá ser utilizado de modo que alguna persona/cosa pueda sufrir daño. El uso del producto fuera de sus fines definidos o sin tener en cuenta las instrucciones del fabricante queda en la responsabilidad del usuario. El fabricante no se hace en ninguna forma responsable de consecuencias a causa del mal uso del producto.







Informaciones elementales de seguridad

Se parte del uso correcto del producto para los fines definidos si el producto es utilizado conforme a las indicaciones de la correspondiente documentación del producto y dentro del margen de rendimiento definido (ver hoja de datos, documentación, informaciones de seguridad que siguen). El uso del producto hace necesarios conocimientos técnicos y ciertos conocimientos del idioma inglés. Por eso se debe tener en cuenta que el producto solo pueda ser operado por personal especializado o personas instruidas en profundidad con las capacidades correspondientes. Si fuera necesaria indumentaria de seguridad para el uso de productos de Rohde & Schwarz, encontraría la información debida en la documentación del producto en el capítulo correspondiente. Guarde bien las informaciones de seguridad elementales, así como la documentación del producto, y entréguelas a usuarios posteriores.

Tener en cuenta las informaciones de seguridad sirve para evitar en lo posible lesiones o daños por peligros de toda clase. Por eso es imprescindible leer detalladamente y comprender por completo las siguientes informaciones de seguridad antes de usar el producto, y respetarlas durante el uso del producto. Deberán tenerse en cuenta todas las demás informaciones de seguridad, como p. ej. las referentes a la protección de personas, que encontrarán en el capítulo correspondiente de la documentación del producto y que también son de obligado cumplimiento. En las presentes informaciones de seguridad se recogen todos los objetos que distribuye el grupo de empresas Rohde & Schwarz bajo la denominación de "producto", entre ellos también aparatos, instalaciones así como toda clase de accesorios.

Símbolos y definiciones de seguridad

							
Aviso: punto de peligro general Observar la documentación del producto	Atención en el manejo de dispositivos de peso elevado	Peligro de choque eléctrico	Advertencia: superficie caliente	Conexión a conductor de protección	Conexión a tierra	Conexión a masa	Aviso: Cuidado en el manejo de dispositivos sensibles a la electrostática (ESD)

					
Tensión de alimentación de PUESTA EN MARCHA / PARADA	Indicación de estado de espera (Standby)	Corriente continua (DC)	Corriente alterna (AC)	Corriente continua / Corriente alterna (DC/AC)	El aparato está protegido en su totalidad por un aislamiento doble (reforzado)

Palabras de señal y su significado

En la documentación del producto se utilizan las siguientes palabras de señal con el fin de advertir contra riesgos y peligros.



PELIGRO identifica un peligro inminente con riesgo elevado que provocará muerte o lesiones graves si no se evita.



ADVERTENCIA identifica un posible peligro con riesgo medio de provocar muerte o lesiones (graves) si no se evita.



ATENCIÓN identifica un peligro con riesgo reducido de provocar lesiones leves o moderadas si no se evita.



AVISO indica la posibilidad de utilizar mal el producto y, como consecuencia, dañarlo.

En la documentación del producto se emplea de forma sinónima el término CUIDADO.

Las palabras de señal corresponden a la definición habitual para aplicaciones civiles en el área económica europea. Pueden existir definiciones diferentes a esta definición en otras áreas económicas o en aplicaciones militares. Por eso se deberá tener en cuenta que las palabras de señal aquí descritas sean utilizadas siempre solamente en combinación con la correspondiente documentación del producto y solamente en combinación con el producto correspondiente. La utilización de las palabras de señal en combinación con productos o documentaciones que no les correspondan puede llevar a interpretaciones equivocadas y tener por consecuencia daños en personas u objetos.

Estados operativos y posiciones de funcionamiento

El producto solamente debe ser utilizado según lo indicado por el fabricante respecto a los estados operativos y posiciones de funcionamiento sin que se obstruya la ventilación. Si no se siguen las indicaciones del fabricante, pueden producirse choques eléctricos, incendios y/o lesiones graves con posible consecuencia de muerte. En todos los trabajos deberán ser tenidas en cuenta las normas nacionales y locales de seguridad del trabajo y de prevención de accidentes.

1. Si no se convino de otra manera, es para los productos Rohde & Schwarz válido lo que sigue: como posición de funcionamiento se define por principio la posición con el suelo de la caja para abajo, modo de protección IP 2X, grado de suciedad 2, categoría de sobrecarga eléctrica 2, uso solamente en estancias interiores, utilización hasta 2000 m sobre el nivel del mar, transporte hasta 4500 m sobre el nivel del mar. Se aplicará una tolerancia de $\pm 10\%$ sobre el voltaje nominal y de $\pm 5\%$ sobre la frecuencia nominal.
2. No sitúe el producto encima de superficies, vehículos, estantes o mesas, que por sus características de peso o de estabilidad no sean aptos para él. Siga siempre las instrucciones de instalación del fabricante cuando instale y asegure el producto en objetos o estructuras (p. ej. paredes y estantes). Si se realiza la instalación de modo distinto al indicado en la documentación del producto, pueden causarse lesiones o incluso la muerte.
3. No ponga el producto sobre aparatos que generen calor (p. ej. radiadores o calefactores). La temperatura ambiente no debe superar la temperatura máxima especificada en la documentación del producto o en la hoja de datos. En caso de sobrecalentamiento del producto, pueden producirse choques eléctricos, incendios y/o lesiones graves con posible consecuencia de muerte.

Seguridad eléctrica

Si no se siguen (o se siguen de modo insuficiente) las indicaciones del fabricante en cuanto a seguridad eléctrica, pueden producirse choques eléctricos, incendios y/o lesiones graves con posible consecuencia de muerte.

1. Antes de la puesta en marcha del producto se deberá comprobar siempre que la tensión preseleccionada en el producto coincida con la de la red de alimentación eléctrica. Si es necesario modificar el ajuste de tensión, también se deberán cambiar en caso dado los fusibles correspondientes del producto.
2. Los productos de la clase de protección I con alimentación móvil y enchufe individual solamente podrán enchufarse a tomas de corriente con contacto de seguridad y con conductor de protección conectado.
3. Queda prohibida la interrupción intencionada del conductor de protección, tanto en la toma de corriente como en el mismo producto. La interrupción puede tener como consecuencia el riesgo de que el producto sea fuente de choques eléctricos. Si se utilizan cables alargadores o regletas de enchufe, deberá garantizarse la realización de un examen regular de los mismos en cuanto a su estado técnico de seguridad.
4. Si el producto no está equipado con un interruptor para desconectarlo de la red, se deberá considerar el enchufe del cable de conexión como interruptor. En estos casos se deberá asegurar que el enchufe siempre sea de fácil acceso (de acuerdo con la longitud del cable de conexión, aproximadamente 2 m). Los interruptores de función o electrónicos no son aptos para el corte de la red eléctrica. Si los productos sin interruptor están integrados en bastidores o instalaciones, se deberá colocar el interruptor en el nivel de la instalación.
5. No utilice nunca el producto si está dañado el cable de conexión a red. Compruebe regularmente el correcto estado de los cables de conexión a red. Asegúrese, mediante las medidas de protección y de instalación adecuadas, de que el cable de conexión a red no pueda ser dañado o de que nadie pueda ser dañado por él, p. ej. al tropezar o por un choque eléctrico.
6. Solamente está permitido el funcionamiento en redes de alimentación TN/TT aseguradas con fusibles de 16 A como máximo (utilización de fusibles de mayor amperaje solo previa consulta con el grupo de empresas Rohde & Schwarz).
7. Nunca conecte el enchufe en tomas de corriente sucias o llenas de polvo. Introduzca el enchufe por completo y fuertemente en la toma de corriente. La no observación de estas medidas puede provocar chispas, fuego y/o lesiones.
8. No sobrecargue las tomas de corriente, los cables alargadores o las regletas de enchufe ya que esto podría causar fuego o choques eléctricos.
9. En las mediciones en circuitos de corriente con una tensión $U_{\text{eff}} > 30 \text{ V}$ se deberán tomar las medidas apropiadas para impedir cualquier peligro (p. ej. medios de medición adecuados, seguros, limitación de tensión, corte protector, aislamiento etc.).
10. Para la conexión con dispositivos informáticos como un PC o un ordenador industrial, debe comprobarse que éstos cumplan los estándares IEC60950-1/EN60950-1 o IEC61010-1/EN 61010-1 válidos en cada caso.
11. A menos que esté permitido expresamente, no retire nunca la tapa ni componentes de la carcasa mientras el producto esté en servicio. Esto pone a descubierto los cables y componentes eléctricos y puede causar lesiones, fuego o daños en el producto.

12. Si un producto se instala en un lugar fijo, se deberá primero conectar el conductor de protección fijo con el conductor de protección del producto antes de hacer cualquier otra conexión. La instalación y la conexión deberán ser efectuadas por un electricista especializado.
13. En el caso de dispositivos fijos que no estén provistos de fusibles, interruptor automático ni otros mecanismos de seguridad similares, el circuito de alimentación debe estar protegido de modo que todas las personas que puedan acceder al producto, así como el producto mismo, estén a salvo de posibles daños.
14. Todo producto debe estar protegido contra sobretensión (debida p. ej. a una caída del rayo) mediante los correspondientes sistemas de protección. Si no, el personal que lo utilice quedará expuesto al peligro de choque eléctrico.
15. No debe introducirse en los orificios de la caja del aparato ningún objeto que no esté destinado a ello. Esto puede producir cortocircuitos en el producto y/o puede causar choques eléctricos, fuego o lesiones.
16. Salvo indicación contraria, los productos no están impermeabilizados (ver también el capítulo "Estados operativos y posiciones de funcionamiento", punto 1). Por eso es necesario tomar las medidas necesarias para evitar la entrada de líquidos. En caso contrario, existe peligro de choque eléctrico para el usuario o de daños en el producto, que también pueden redundar en peligro para las personas.
17. No utilice el producto en condiciones en las que pueda producirse o ya se hayan producido condensaciones sobre el producto o en el interior de éste, como p. ej. al desplazarlo de un lugar frío a otro caliente. La entrada de agua aumenta el riesgo de choque eléctrico.
18. Antes de la limpieza, desconecte por completo el producto de la alimentación de tensión (p. ej. red de alimentación o batería). Realice la limpieza de los aparatos con un paño suave, que no se deshilache. No utilice bajo ningún concepto productos de limpieza químicos como alcohol, acetona o diluyentes para lacas nitrocelulósicas.

Funcionamiento

1. El uso del producto requiere instrucciones especiales y una alta concentración durante el manejo. Debe asegurarse que las personas que manejen el producto estén a la altura de los requerimientos necesarios en cuanto a aptitudes físicas, psíquicas y emocionales, ya que de otra manera no se pueden excluir lesiones o daños de objetos. El empresario u operador es responsable de seleccionar el personal usuario apto para el manejo del producto.
2. Antes de desplazar o transportar el producto, lea y tenga en cuenta el capítulo "Transporte".
3. Como con todo producto de fabricación industrial no puede quedar excluida en general la posibilidad de que se produzcan alergias provocadas por algunos materiales empleados, los llamados alérgenos (p. ej. el níquel). Si durante el manejo de productos Rohde & Schwarz se producen reacciones alérgicas, como p. ej. irritaciones cutáneas, estornudos continuos, enrojecimiento de la conjuntiva o dificultades respiratorias, debe avisarse inmediatamente a un médico para investigar las causas y evitar cualquier molestia o daño a la salud.
4. Antes de la manipulación mecánica y/o térmica o el desmontaje del producto, debe tenerse en cuenta imprescindiblemente el capítulo "Eliminación", punto 1.

5. Ciertos productos, como p. ej. las instalaciones de radiocomunicación RF, pueden a causa de su función natural, emitir una radiación electromagnética aumentada. Deben tomarse todas las medidas necesarias para la protección de las mujeres embarazadas. También las personas con marcapasos pueden correr peligro a causa de la radiación electromagnética. El empresario/operador tiene la obligación de evaluar y señalar las áreas de trabajo en las que exista un riesgo elevado de exposición a radiaciones.
6. Tenga en cuenta que en caso de incendio pueden desprenderse del producto sustancias tóxicas (gases, líquidos etc.) que pueden generar daños a la salud. Por eso, en caso de incendio deben usarse medidas adecuadas, como p. ej. máscaras antigás e indumentaria de protección.
7. En caso de que un producto Rohde & Schwarz contenga un producto láser (p. ej. un lector de CD/DVD), no debe usarse ninguna otra configuración o función aparte de las descritas en la documentación del producto, a fin de evitar lesiones (p. ej. debidas a irradiación láser).

Reparación y mantenimiento

1. El producto solamente debe ser abierto por personal especializado con autorización para ello. Antes de manipular el producto o abrirlo, es obligatorio desconectarlo de la tensión de alimentación, para evitar toda posibilidad de choque eléctrico.
2. El ajuste, el cambio de partes, el mantenimiento y la reparación deberán ser efectuadas solamente por electricistas autorizados por Rohde & Schwarz. Si se reponen partes con importancia para los aspectos de seguridad (p. ej. el enchufe, los transformadores o los fusibles), solamente podrán ser sustituidos por partes originales. Después de cada cambio de partes relevantes para la seguridad deberá realizarse un control de seguridad (control a primera vista, control del conductor de protección, medición de resistencia de aislamiento, medición de la corriente de fuga, control de funcionamiento). Con esto queda garantizada la seguridad del producto.

Baterías y acumuladores o celdas

Si no se siguen (o se siguen de modo insuficiente) las indicaciones en cuanto a las baterías y acumuladores o celdas, pueden producirse explosiones, incendios y/o lesiones graves con posible consecuencia de muerte. El manejo de baterías y acumuladores con electrolitos alcalinos (p. ej. celdas de litio) debe seguir el estándar EN 62133.

1. No deben desmontarse, abrirse ni triturarse las celdas.
2. Las celdas o baterías no deben someterse a calor ni fuego. Debe evitarse el almacenamiento a la luz directa del sol. Las celdas y baterías deben mantenerse limpias y secas. Limpiar las conexiones sucias con un paño seco y limpio.
3. Las celdas o baterías no deben cortocircuitarse. Es peligroso almacenar las celdas o baterías en estuches o cajones en cuyo interior puedan cortocircuitarse por contacto recíproco o por contacto con otros materiales conductores. No deben extraerse las celdas o baterías de sus embalajes originales hasta el momento en que vayan a utilizarse.
4. Mantener baterías y celdas fuera del alcance de los niños. En caso de ingestión de una celda o batería, avisar inmediatamente a un médico.
5. Las celdas o baterías no deben someterse a impactos mecánicos fuertes indebidos.

Informaciones elementales de seguridad

6. En caso de falta de estanqueidad de una celda, el líquido vertido no debe entrar en contacto con la piel ni los ojos. Si se produce contacto, lavar con agua abundante la zona afectada y avisar a un médico.
7. En caso de cambio o recarga inadecuados, las celdas o baterías que contienen electrolitos alcalinos (p. ej. las celdas de litio) pueden explotar. Para garantizar la seguridad del producto, las celdas o baterías solo deben ser sustituidas por el tipo Rohde & Schwarz correspondiente (ver lista de recambios).
8. Las baterías y celdas deben reciclarse y no deben tirarse a la basura doméstica. Las baterías o acumuladores que contienen plomo, mercurio o cadmio deben tratarse como residuos especiales. Respete en esta relación las normas nacionales de eliminación y reciclaje.

Transporte

1. El producto puede tener un peso elevado. Por eso es necesario desplazarlo o transportarlo con precaución y, si es necesario, usando un sistema de elevación adecuado (p. ej. una carretilla elevadora), a fin de evitar lesiones en la espalda u otros daños personales.
2. Las asas instaladas en los productos sirven solamente de ayuda para el transporte del producto por personas. Por eso no está permitido utilizar las asas para la sujeción en o sobre medios de transporte como p. ej. grúas, carretillas elevadoras de horquilla, carros etc. Es responsabilidad suya fijar los productos de manera segura a los medios de transporte o elevación. Para evitar daños personales o daños en el producto, siga las instrucciones de seguridad del fabricante del medio de transporte o elevación utilizado.
3. Si se utiliza el producto dentro de un vehículo, recae de manera exclusiva en el conductor la responsabilidad de conducir el vehículo de manera segura y adecuada. El fabricante no asumirá ninguna responsabilidad por accidentes o colisiones. No utilice nunca el producto dentro de un vehículo en movimiento si esto pudiera distraer al conductor. Asegure el producto dentro del vehículo debidamente para evitar, en caso de un accidente, lesiones u otra clase de daños.

Eliminación

1. Si se trabaja de manera mecánica y/o térmica cualquier producto o componente más allá del funcionamiento previsto, pueden liberarse sustancias peligrosas (polvos con contenido de metales pesados como p. ej. plomo, berilio o níquel). Por eso el producto solo debe ser desmontado por personal especializado con formación adecuada. Un desmontaje inadecuado puede ocasionar daños para la salud. Se deben tener en cuenta las directivas nacionales referentes a la eliminación de residuos.
2. En caso de que durante el trato del producto se formen sustancias peligrosas o combustibles que deban tratarse como residuos especiales (p. ej. refrigerantes o aceites de motor con intervalos de cambio definidos), deben tenerse en cuenta las indicaciones de seguridad del fabricante de dichas sustancias y las normas regionales de eliminación de residuos. Tenga en cuenta también en caso necesario las indicaciones de seguridad especiales contenidas en la documentación del producto. La eliminación incorrecta de sustancias peligrosas o combustibles puede causar daños a la salud o daños al medio ambiente.

Kundeninformation zur Batterieverordnung (BattV)

Dieses Gerät enthält eine schadstoffhaltige Batterie. Diese darf nicht mit dem Hausmüll entsorgt werden.

Nach Ende der Lebensdauer darf die Entsorgung nur über eine Rohde&Schwarz-Kundendienststelle oder eine geeignete Sammelstelle erfolgen.

Safety Regulations for Batteries (according to BattV)

This equipment houses a battery containing harmful substances that must not be disposed of as normal household waste.

After its useful life, the battery may only be disposed of at a Rohde & Schwarz service center or at a suitable depot.

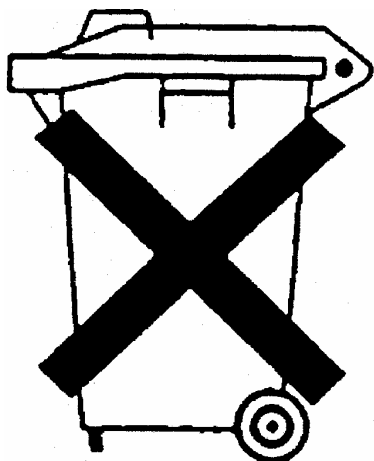

Normas de Seguridad para Baterías (Según BattV)

Este equipo lleva una batería que contiene sustancias perjudiciales, que no se debe desechar en los contenedores de basura domésticos.

Después de la vida útil, la batería sólo se podrá eliminar en un centro de servicio de Rohde & Schwarz o en un depósito apropiado.

Consignes de sécurité pour batteries (selon BattV)

Cet appareil est équipé d'une pile comprenant des substances nocives. Ne jamais la jeter dans une poubelle pour ordures ménagères.

Une pile usagée doit uniquement être éliminée par un centre de service client de Rohde & Schwarz ou peut être collectée pour être traitée spécialement comme déchets dangereux.

Customer Information Regarding Product Disposal

The German Electrical and Electronic Equipment (ElektroG) Act is an implementation of the following EC directives:

- 2002/96/EC on waste electrical and electronic equipment (WEEE) and
- 2002/95/EC on the restriction of the use of certain hazardous substances in electrical and electronic equipment (RoHS).

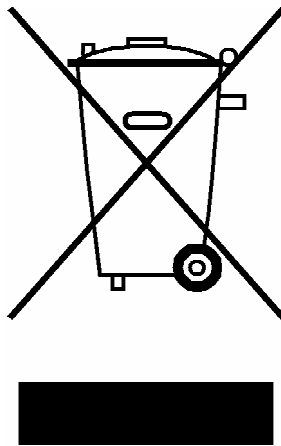

Product labeling in accordance with EN 50419

Once the lifetime of a product has ended, this product must not be disposed of in the standard domestic refuse. Even disposal via the municipal collection points for waste electrical and electronic equipment is not permitted.

Rohde & Schwarz GmbH & Co. KG has developed a disposal concept for the environmental-friendly disposal or recycling of waste material and fully assumes its obligation as a producer to take back and dispose of electrical and electronic waste in accordance with the ElektroG Act.

Please contact your local service representative to dispose of the product.



Qualitätszertifikat

Certificate of quality

Certificat de qualité

Certified Quality System
ISO 9001

Certified Environmental System
ISO 14001

Sehr geehrter Kunde,

Sie haben sich für den Kauf eines Rohde&Schwarz-Produktes entschieden. Hiermit erhalten Sie ein nach modernsten Fertigungsmethoden hergestelltes Produkt. Es wurde nach den Regeln unseres Qualitätsmanagementsystems entwickelt, gefertigt und geprüft. Das Rohde&Schwarz-Qualitätsmanagementsystem ist u.a. nach ISO9001 und ISO14001 zertifiziert.

Der Umwelt verpflichtet

- ▮ Energie-effiziente, RoHS-konforme Produkte
- ▮ Kontinuierliche Weiterentwicklung nachhaltiger Umweltkonzepte
- ▮ ISO 14001-zertifiziertes Umweltmanagementsystem

Dear Customer,

You have decided to buy a Rohde&Schwarz product. You are thus assured of receiving a product that is manufactured using the most modern methods available. This product was developed, manufactured and tested in compliance with our quality management system standards. The Rohde&Schwarz quality management system is certified according to standards such as ISO9001 and ISO14001.

Environmental commitment

- ▮ Energy-efficient products
- ▮ Continuous improvement in environmental sustainability
- ▮ ISO 14001-certified environmental management system

Cher client,

Vous avez choisi d'acheter un produit Rohde&Schwarz. Vous disposez donc d'un produit fabriqué d'après les méthodes les plus avancées. Le développement, la fabrication et les tests respectent nos normes de gestion qualité. Le système de gestion qualité de Rohde&Schwarz a été homologué, entre autres, conformément aux normes ISO9001 et ISO14001.

Engagement écologique

- ▮ Produits à efficience énergétique
- ▮ Amélioration continue de la durabilité environnementale
- ▮ Système de gestion de l'environnement certifié selon ISO 14001



ROHDE & SCHWARZ

EC Certificate of Conformity



Certificate No.: 2006-101

This is to certify that:

Equipment type	Stock No.	Designation
SMF100A	1167.0000.02	Signal Generator Basic Unit
SMF-B122	1167.7004.03	Frequency Range 1 GHz to 22 GHz
SMF-B144	1167.7204.03	Frequency Range 1 GHz to 43.5 GHz
SMF-B1	1167.9159.02	Reference Oscillator OCXO
SMF-B2	1167.4005.02	Frequency Extension 100 kHz to 1 GHz
SMF-B20	1167.9594.02	AM/FM/Scan Modulator
SMF-B22	1415.2204.02	Enhanced Phase Noise Performance
SMF-B26	1167.5553.02	Step Attenuator 100 kHz bis 22 GHz
SMF-B27	1167.5776.02	Step Attenuator 100 kHz bis 43,5 GHz
SMF-B31	1167.7404.02	High-Output-Power 1 GHz bis 22 GHz
SMF-B32	1415.2304.02/ .03	High Output Power
SMF-B34	1415.2424.02	High-Output-Power
SMF-B81	1167.5999.02	Rear Connectors for RF to 22 GHz, AF
SMF-B82	1167.6208.02	Rear Connectors for RF to 43,5 GHz, AF
SMF-B83	1167.6408.02	Removable GPIB
SMF-B84	1167.6608.02	Removable USB
SMF-B85	1167.6808.02	Removable Flash-Card

complies with the provisions of the Directive of the Council of the European Union on the approximation of the laws of the Member States

- relating to electrical equipment for use within defined voltage limits (2006/95/EC)
- relating to electromagnetic compatibility (2004/108/EC)

Conformity is proven by compliance with the following standards:

EN 61010-1 : 2001
EN 61326-1 : 2006
EN 61326-2-1 : 2006
EN 55011 : 1998 + A1 : 1999 + A2 : 2002, class A
EN 61000-3-2 : 2006
EN 61000-3-3 : 1995 + A1 : 2001 + A2 : 2005

For the assessment of electromagnetic compatibility, the limits of radio interference for Class A equipment as well as the immunity to interference for operation in industry have been used as a basis.

Affixing the EC conformity mark as from 2006

Munich, 2009-03-17

ROHDE & SCHWARZ GmbH & Co. KG
Mühldorfstr. 15, D-81671 München
Central Quality Management MF-QZ / Radde

Customer Support

Technical support – where and when you need it

For quick, expert help with any Rohde & Schwarz equipment, contact one of our Customer Support Centers. A team of highly qualified engineers provides telephone support and will work with you to find a solution to your query on any aspect of the operation, programming or applications of Rohde & Schwarz equipment.

Up-to-date information and upgrades

To keep your instrument up-to-date and to be informed about new application notes related to your instrument, please send an e-mail to the Customer Support Center stating your instrument and your wish. We will take care that you will get the right information.

Europe, Africa, Middle East

Phone +49 89 4129 12345
customersupport@rohde-schwarz.com

North America

Phone 1-888-TEST-RSA (1-888-837-8772)
customer.support@rsa.rohde-schwarz.com

Latin America

Phone +1-410-910-7988
customersupport.la@rohde-schwarz.com

Asia/Pacific

Phone +65 65 13 04 88
customersupport.asia@rohde-schwarz.com

China

Phone +86-800-810-8228 /
+86-400-650-5896
customersupport.china@rohde-schwarz.com



Contents

1	Preface	13
1.1	Documentation Overview.....	13
1.2	Typographical Conventions.....	14
2	Preparing for Use	15
2.1	Front Panel Tour.....	15
2.1.1	Utility Keys.....	16
2.1.2	Standby LEDs and Standby Key.....	16
2.1.3	Display.....	17
2.1.4	Setup Keys.....	17
2.1.4.1	Keys for Setting Paramters.....	17
2.1.4.2	Display Keys.....	18
2.1.5	Keypad for data entry.....	19
2.1.6	Rotary Knob and Navigation Keys.....	20
2.1.7	Front Panel Connectors.....	21
2.2	Rear Panel Tour.....	22
2.2.1	Description of the Connectors.....	22
2.3	Putting into Operation.....	26
2.3.1	Unpacking and Checking the Instrument.....	27
2.3.2	Placing or Mounting the Instrument.....	27
2.3.3	Connecting the Instrument to the AC Supply.....	28
2.3.4	Starting the Instrument.....	29
2.3.4.1	Standby and Ready state.....	29
2.3.4.2	Start Display and Booting.....	29
2.3.4.3	Function Check.....	30
2.3.4.4	Default Settings.....	30
2.3.5	Shutting Down the Instrument.....	31
2.3.6	Power Fuses.....	32
2.4	Connecting External Accessories.....	32
2.4.1	Connecting USB Devices.....	32
2.5	Linux Operating System.....	33
2.6	Setting Up a Network (LAN) Connection.....	35

2.6.1	Connecting the Instrument to the Network.....	35
2.6.2	Assigning the IP Address.....	36
2.6.3	Using Computer Names.....	37
2.7	Remote Access via an External Controller.....	38
2.7.1	Using a Web Browser for Remote Access.....	39
2.7.2	Remote Access via Ultr@VNC.....	40
3	Getting Started.....	45
3.1	Brief Introduction to the Instrument's Concept.....	45
3.2	Application Field of the Instrument.....	47
3.3	Description of Individual Diagram Blocks.....	47
3.4	Example of Setup.....	50
4	Manual Operation.....	59
4.1	Key Features.....	59
4.2	Display.....	63
4.2.1	Settings Displayed in the Header Section.....	63
4.2.2	Status Information and Messages.....	64
4.2.2.1	Status Information.....	64
4.2.2.2	Messages.....	64
4.2.2.3	Volatile messages.....	64
4.2.2.4	Permanent Messages.....	65
4.2.3	Info Window.....	65
4.2.4	Block Diagram	66
4.2.4.1	Function Blocks in the Block Diagram.....	66
4.2.4.2	Signal Flow and Input/Output Symbols in the Block Diagram.....	67
4.2.5	Structure of the Dialogs.....	67
4.3	Accessing Dialogs.....	68
4.4	Setting Parameters.....	69
4.4.1	Working with the Cursor.....	70
4.4.2	Selecting a Control Element.....	71
4.4.3	Switching Parameters On/Off.....	71
4.4.4	Entering a Value.....	71
4.4.5	Working with Units	73
4.4.6	Selecting a Value from a List.....	74

4.4.7	Terminating Entries with Confirmation.....	74
4.4.8	Restoring the Previous Value.....	75
4.5	Editors.....	76
4.5.1	Working with List Editor.....	76
4.6	How to Use the Help System.....	77
4.7	File Management.....	79
4.7.1	File Select Dialog.....	80
4.7.2	File Manager.....	81
4.7.2.1	Extensions for User Files.....	82
4.8	Legend of Front-Panel Controls.....	83
4.8.1	Front Panel Key Emulation.....	84
5	Instrument Function.....	87
5.1	Overview of Instrument Functions.....	87
5.2	General Instrument Settings.....	89
5.2.1	Overview of General Instrument Settings.....	89
5.2.2	Default Instrument Settings - Preset Key.....	89
5.2.3	General Configuration of Instrument - Setup Key.....	90
5.2.3.1	Internal Adjustments.....	90
5.2.3.2	Hardware Config.....	92
5.2.3.3	Software / Options.....	94
5.2.3.4	Manage License Keys.....	95
5.2.3.5	Gui Update.....	96
5.2.3.6	NRP-Z Info/Update.....	97
5.2.3.7	Update.....	98
5.2.3.8	Check Front Panel.....	98
5.2.3.9	Date and Time	98
5.2.3.10	Network Settings	99
5.2.3.11	Display/Keyboard Settings.....	101
5.2.3.12	Auxiliary I/O Settings.....	102
5.2.3.13	Remote Channel Settings.....	104
5.2.3.14	Protection.....	106
5.2.3.15	Security.....	107
5.2.3.16	Save/Recall.....	111

5.2.3.17	Factory Preset.....	111
5.2.3.18	Help.....	111
5.2.4	Switching to Manual Control - Local Key.....	112
5.2.5	Generating a Hard Copy of the Display.....	112
5.2.5.1	Hardcopy Dialog.....	113
5.2.5.2	Hardcopy Options.....	113
5.2.6	Messages - Info Key.....	115
5.2.7	Help System - Help Key.....	116
5.2.8	Storing and Loading Instrument Data - File Key.....	117
5.2.8.1	File Menu.....	118
5.2.8.2	Storing Instrument Settings.....	118
5.2.8.3	Loading Instrument Settings.....	119
5.2.8.4	File Manager.....	121
5.3	RF Signal - RF Frequency Block.....	122
5.3.1	Overview of RF Signal.....	122
5.3.1.1	RF Output.....	123
5.3.1.2	Overview of the RF Signal Settings.....	123
5.3.2	RF Frequency Settings.....	124
5.3.2.1	RF Frequency vs. RF Output Frequency.....	124
5.3.2.2	Configuring RF Frequency.....	125
5.3.2.3	Frequency Menu.....	125
5.3.3	Phase Settings.....	127
5.3.3.1	Phase Menu.....	127
5.3.4	Sweep Mode.....	127
5.3.4.1	Overview.....	127
5.3.4.2	RF Frequency Sweep.....	129
5.3.5	List Mode.....	137
5.3.5.1	List Mode Dialog.....	138
5.3.5.2	Filling the List Mode Data automatically.....	145
5.3.6	Reference Oscillator.....	146
5.3.6.1	Reference Oscillator Dialog.....	147
5.4	RF Level/EMF.....	149
5.4.1	Overview of RF Level.....	149

5.4.1.1	RF level vs. RF output level.....	149
5.4.1.2	Setting the RF level.....	150
5.4.2	RF Level.....	150
5.4.2.1	Level Settings.....	151
5.4.2.2	User Variation.....	152
5.4.3	Power-On/EMF Settings.....	152
5.4.4	RF Level Sweep.....	153
5.4.4.1	RF Level Sweep Settings.....	153
5.4.4.2	RF Level Marker.....	158
5.4.5	Automatic Level Control - ALC.....	160
5.4.5.1	Automatic Level Control Settings.....	161
5.4.5.2	External Level Control.....	162
5.4.6	Power Sensors.....	163
5.4.6.1	NRP-Z Power Viewer.....	164
5.4.6.2	NRP-Z Power Analysis.....	169
5.4.7	User Correction.....	208
5.4.7.1	User Correction Menu.....	209
5.4.7.2	Filling the Correction List automatically.....	213
5.4.7.3	Filling the Correction List with Power Sensor Measurement Data.....	214
5.5	Modulations.....	215
5.5.1	Overview of Modulation.....	215
5.5.1.1	Enabling/Disabling Analog Modulations using the MOD On/Off Key.....	216
5.5.1.2	Modulation Sources.....	216
5.5.2	Amplitude Modulation (AM).....	218
5.5.2.1	Amplitude Modulation Menu.....	218
5.5.3	Frequency Modulation (FM).....	221
5.5.3.1	Frequency Modulation Settings.....	221
5.5.4	Phase Modulation (PhiM).....	223
5.5.4.1	Phase Modulation Menu.....	224
5.5.5	Digital Modulation.....	226
5.5.5.1	Digital Modulation Menu.....	226
5.5.6	Pulse Modulation (PM).....	229
5.5.6.1	Pulse Modulation Settings.....	229

5.5.7	Chirp Modulation.....	231
5.5.7.1	Chirp Modulation Settings.....	232
5.6	LF Gen./Noise.....	235
5.6.1	LF Generator Settings.....	236
5.6.2	Noise Settings.....	239
5.6.3	LF Frequency Sweep.....	239
5.6.4	LF Frequency Marker Settings.....	245
5.7	LF Output.....	247
5.7.1	LF Output Settings.....	247
5.7.2	LF Level Sweep.....	249
5.7.2.1	LF Level Sweep Settings.....	249
5.7.3	LF Level Marker Settings.....	254
5.8	Pulse Generator.....	255
5.8.1	Pulse Generator Settings.....	255
5.8.2	Pulse Train Generation.....	259
5.9	Attenuator.....	263
5.9.1	Attenuator Settings.....	263
5.10	R&S SMZ Frequency Multiplier.....	264
6	Remote Control Basics.....	265
6.1	Remote Control Interfaces and Protocols.....	265
6.1.1	VISA Libraries.....	266
6.1.2	Messages.....	266
6.1.3	LAN Interface.....	267
6.1.3.1	VXI-11 Protocol.....	268
6.1.3.2	Socket Communication.....	268
6.1.3.3	LAN Interface Messages.....	268
6.1.4	USB Interface.....	269
6.1.5	Serial Interface.....	269
6.1.6	GPIB Interface (IEC/IEEE Bus Interface).....	270
6.1.6.1	GPIB Interface Messages.....	270
6.1.6.2	GPIB Instrument Address.....	271
6.2	Starting a Remote Control Session.....	272
6.2.1	Switching to Remote Control.....	272

6.2.2	Returning to Manual Operation.....	273
6.2.3	Examples.....	273
6.2.3.1	Remote Control over GPIB.....	274
6.2.3.2	Remote Control over LAN using VXI-11 Protocol.....	274
6.2.3.3	Remote Control over LAN using Socket Communication.....	278
6.3	SCPI Command Structure.....	284
6.3.1	Syntax for Common Commands.....	284
6.3.2	Syntax for Device-Specific Commands.....	285
6.3.3	SCPI Parameters.....	287
6.3.4	Overview of Syntax Elements.....	290
6.3.5	Structure of a command line.....	291
6.3.6	Responses to Queries.....	292
6.4	Command Sequence and Synchronization.....	292
6.4.1	Preventing Overlapping Execution.....	293
6.5	Status Reporting System.....	295
6.5.1	Hierarchy of status registers.....	295
6.5.2	Structure of a SCPI Status Register.....	297
6.5.3	Contents of the Status Registers.....	298
6.5.3.1	Status Byte (STB) and Service Request Enable Register (SRE).....	298
6.5.3.2	IST Flag and Parallel Poll Enable Register (PPE).....	299
6.5.4	Event Status Register (ESR) and Event Status Enable Register (ESE).....	299
6.5.5	Application of the Status Reporting System.....	300
6.5.5.1	Service Request.....	301
6.5.5.2	Serial Poll.....	301
6.5.5.3	Parallel Poll.....	301
6.5.5.4	Query of an instrument status.....	302
6.5.5.5	Error Queue.....	302
6.5.6	Reset Values of the Status Reporting System.....	302
6.6	General Programming Recommendations.....	303
7	Remote Control Commands.....	305
7.1	Common Commands.....	305
7.2	Preset Commands.....	309
7.3	CALibration Subsystem.....	311

7.4	DIAGnostic Subsystem	313
7.5	DISPlay Subsystem	315
7.6	FORMat Subsystem	316
7.7	HCOPy Subsystem	317
7.8	KBOard Subsystem	324
7.9	MMEMory Subsystem	324
7.9.1	File Naming Conventions.....	325
7.9.2	Extensions for User Files.....	325
7.9.3	Examples.....	326
7.9.4	Remote Control Commands.....	327
7.10	OUTPut Subsystem	332
7.11	Power Sensor Measurement Subsystems	336
7.11.1	CALCulate Subsystem.....	337
7.11.2	DISPlay Subsystem.....	341
7.11.3	INITiate Command.....	342
7.11.4	READ Subsystem.....	342
7.11.5	SENSe Subsystem.....	343
7.11.6	TRACe Subsystem.....	382
7.12	SOURce Subsystem	391
7.12.1	SOURce:AM Subsystem.....	392
7.12.2	SOURce:CHIRp Subsystem.....	394
7.12.3	SOURce:CORRection Subsystem.....	398
7.12.4	SOURce:DM Subsystem.....	407
7.12.5	SOURce:FM Subsystem.....	410
7.12.6	SOURce:FREQUency Subsystem.....	412
7.12.7	SOURce:INPut Subsystem.....	419
7.12.8	SOURce:LFOutput Subsystem.....	420
7.12.9	SOURce:LIST Subsystem.....	441
7.12.10	SOURce:MODulation Subsystem.....	455
7.12.11	SOURce:NOISe Subsystem.....	455
7.12.12	SOURce:PGEN Subsystem.....	456
7.12.13	SOURce:PHASe Subsystem.....	457
7.12.14	SOURce:PM Subsystem.....	458

7.12.15	SOURce:POWer Subsystem.....	460
7.12.16	SOURce:PULM Subsystem.....	469
7.12.17	SOURce:ROSCillator Subsystem.....	484
7.12.18	SOURce:SWEep Subsystem.....	487
7.13	STATus Subsystem.....	499
7.14	SYSTem Subsystem.....	504
7.15	TEST Subsystem.....	516
7.16	TRIGger Subsystem.....	516
7.17	UNIT Subsystem.....	522
8	Maintenance.....	525
8.1	Storing and Packing.....	525
9	Error Messages.....	527
9.1	Status Information.....	527
9.1.1	Status information displayed between the frequency and level fields.....	527
9.1.2	Status information displayed to the left of the Info line.....	528
9.1.3	Status information displayed in the Info line.....	529
9.2	Error Messages.....	530
9.2.1	Volatile messages.....	530
9.2.2	Permanent messages.....	530
9.3	SCPI-Error Messages.....	530
9.4	Device-Specific Error Messages.....	531
A	Hardware Interfaces.....	533
A.1	GPIB Bus Interface.....	533
	List of Commands.....	535
	Index.....	548

1 Preface

1.1 Documentation Overview

The user documentation for the R&S SMF consists of the following parts:

- Online Help system on the instrument,
- "Quick Start Guide" printed manual,
- Documentation CD-ROM with:
 - Online help system (*.chm) as a standalone help,
 - Operating Manual,
 - Service Manual,
 - Data sheet and specifications,
 - Links to useful sites on the R&S internet.

Online Help

The Online Help is embedded in the instrument's firmware. It offers quick, context-sensitive access to the complete information needed for operation and programming. The online help contains help on operating the R&S SMF and all available options.

Quick Start Guide

This manual is delivered with the instrument in printed form and in PDF format on the Documentation CD-ROM. It provides the information needed to set up and start working with the instrument. Basic operations and an example of setup are described. The manual includes also general information, e.g., Safety Instructions.

Operating Manual

The Operating Manual is a supplement to the Quick Start Guide. The manual is available in PDF format - in printable form - on the Documentation CD-ROM delivered with the instrument. In the Operating Manual, all instrument functions are described in detail. Furthermore, it provides an introduction to remote control and a complete description of the remote control commands with programming examples. Information on maintenance, instrument interfaces and error messages is also given. The manual can also be ordered in printed form (see ordering information in the data sheet).

Service Manual

This Service Manual is available in PDF format - in printable form - on the Documentation CD-ROM delivered with the instrument. It describes how to check compliance with rated specifications, on instrument function, repair, troubleshooting and fault elimination. It contains all information required for repairing the instrument by the replacement of modules.

This manual can also be ordered in printed form (see ordering information in the data sheet).

Release Notes

The release notes describe new and modified functions, eliminated problems, and last minute changes to the documentation. The corresponding firmware version is indicated on the title page of the release notes. The current release notes are provided in the Internet.

1.2 Typographical Conventions

The following text markers are used throughout this documentation:

Convention	Description
"Graphical user interface elements"	All names of graphical user interface elements on the screen, such as dialog boxes, menus, options, buttons, and softkeys are enclosed by quotation marks.
KEYS	Key names are written in capital letters.
File names, commands, program code	File names, commands, coding samples and screen output are distinguished by their font.
<i>Input</i>	Input to be entered by the user is displayed in italics.
Links	Links that you can click are displayed in blue font.
"References"	References to other parts of the documentation are enclosed by quotation marks.

2 Preparing for Use

The following topics will help you to get familiar with the instrument and perform the first steps:

- [Front Panel Tour](#)
- [Rear Panel Tour](#)
- [Putting into Operation](#)

This section explains the control elements and connectors of the Signal Generator R&S SMF with the aid of the front and rear views and describes how to put the instrument into operation. It also describes the connection of peripherals such as printer, keyboard or mouse. Specifications of interfaces can be found in the data sheet.

The [chapter 3, "Getting Started"](#), on page 45 of this manual provides an overview of the generator functions and introduces the operating concept. Detailed operating instructions and an overview of menus follow in [chapter 4, "Manual Operation"](#), on page 59.

For all reference information concerning manual and remote control of the instrument refer to the online help system or its printed/printable version. A more detailed description of the hardware connectors and interfaces is also part of the help system.

2.1 Front Panel Tour

The front panel of the R&S Microwave Signal Generator consists of the VGA display, some utility keys (left side) and the hardkey area with connectors and control interfaces (right side). The subsequent sections provide brief explanations on the controls and connectors, the hardkey area and the front panel.

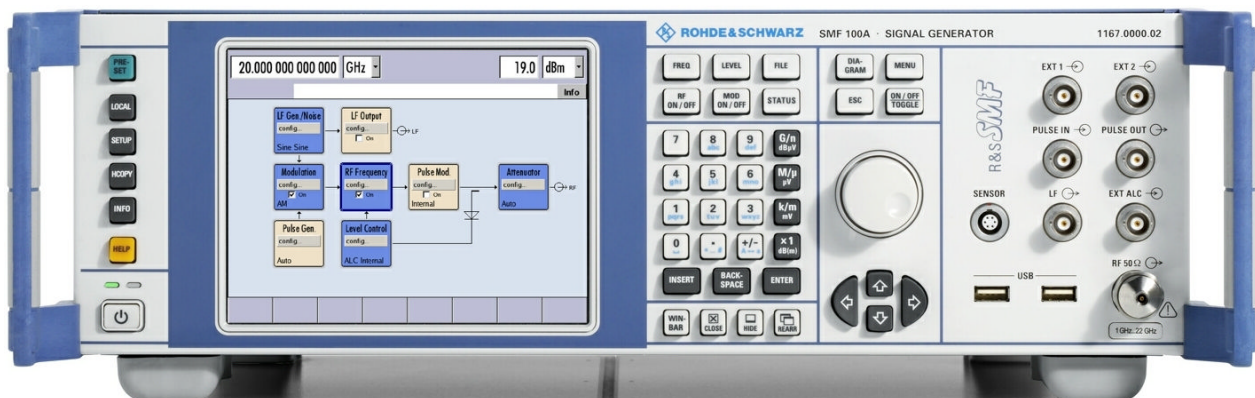

Fig. 2-1: Front panel view

2.1.1 Utility Keys



The keys to the left of the display cause the R&S SMF to return to a definite instrument state and provide information on the instrument and assistance.

For more information refer to chapter "Instrument Settings".

PRESET

Sets the instrument to a defined state (see [chapter 2.3.4.4, "Default Settings"](#), on page 30).

LOCAL

Switches from remote control to local (manual) control.

SETUP

Opens the "Setup" dialog for configuring presettings.

For more information, see [chapter 5.2.3, "General Configuration of Instrument - Setup Key"](#), on page 90.

HCOPI

Opens the "Hardcopy" menu for configuring and starting printing.

For more information, see [chapter 5.2.5, "Generating a Hard Copy of the Display"](#), on page 112.

INFO

Displays status messages, error messages and warnings.

HELP

Displays context-sensitive help text.

2.1.2 Standby LEDs and Standby Key

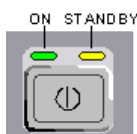

The standby LEDs and the ON/STANDBY key are located in the bottom left corner of the front panel.

The ON/STANDBY key toggles the instrument between standby and ready state (indicated by the standby LEDs).

The standby LEDs indicate the instrument states as follow:

- the green LED (left) is on when the instrument is ready for operation,

- the yellow LED (right) is on in the standby mode.

See also [chapter 2.3.4.1, "Standby and Ready state"](#), on page 29.

2.1.3 Display

The display clearly shows all main settings and signal generator states.

The display is divided into the following sections:

- Frequency and level display with info line
 - Frequency and level settings containing offset.
 - Status messages
 - Brief error messages.
To access an window with detailed information for a message, use the INFO key.
- Block diagram
 - The block diagram shows the current configuration and the signal flow in the generator with the aid of function blocks containing an on/off switch. Selecting a function block opens a list of associated setting menus. Active menus, info windows and graphs are displayed on top of the block diagram. The block diagram can be displayed in the foreground anytime with the [DIAGRAM](#) key.
- "Winbar" at the bottom of the display
 - Open menus are indicated by a labelled button in the "Winbar". When a button is pressed, the associated menu is displayed either in the foreground or minimized in the "Winbar".
 - Pressing the WINBAR key to access the "Windbar".

For detailed information, see [chapter 4.2, "Display"](#), on page 63.

2.1.4 Setup Keys

The keys to the right of the display set parameters, select views and control the windows.

2.1.4.1 Keys for Setting Paramters

These keys provide direct access to the settings in the header of the instrument and can be used for fast changing the state of the modulation and the RF signal.



For more information refer to chapter "Instrument Functions".

FREQ

Activates frequency entry.

RF ON/OFF

Switches the RF signal on and off.

"RF OFF" is displayed in the header next to the "Frequency" field.

LEVEL

Activates level entry.

MOD ON/OFF

Switches the modulations on and off.

"MOD OFF" is displayed in the info line of the header next to the "Level" field.

FILE

Activates the menu for storing or loading files (see [chapter 4.7, "File Management"](#), on page 79).

STATUS

Indicates the instrument status.

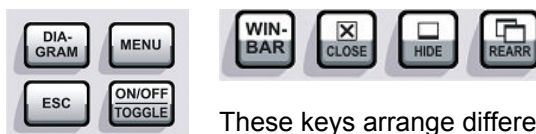
2.1.4.2 Display Keys

These keys arrange different windows on the display, and turn the RF signal and modulation on and off.

DIAGRAM

Brings the block diagram to the foreground. Active menus are minimized.

Active menus are indicated by the buttons in the "Winbar".

ESC

The function of this key depends on the current cursor position.

- Calls the next higher selection level.
- Closes the open window without accepting new entries; the old value or parameter is retained.
- In dialog boxes that contain a "Cancel" button it activates that button.
- Closes all kinds of dialog boxes, if the edit mode is not active.
- Quits the edit mode, if the edit mode is active.
- Switches between different entry fields of a menu.
- Shifts the entry cursor from the header display to the previously active menu, or to the previously highlighted block in the block diagram if no menu is active.

TOGGLE

- Switches highlighted elements or a function block on and off.
- Switches between two or more settings, e.g. items of selection lists. At the end of a list, the cursor is set on the first entry again.

MENU

Calls the menu tree.

WINBAR

Toggles between display and blanking of the "Winbar".

CLOSE

Closes the active menu.

- If the entry mode is active, changes are cancelled.
- If settings in this menu require acknowledgement by means of an "Accept" button, a query is displayed asking whether the changes made should be cancelled.

HIDE

Minimizes the active open menu. The associated button in the "Winbar" remains visible.

REARR

Automatic rearrangement of open menus.

2.1.5 Keypad for data entry

The keys in the data entry keypad are used to enter alphanumeric data and units.

Data entry keys are only enabled while the cursor is placed on a data input field in a dialog. Their function depends on the data type of the input field.



Keys	Description
0...9/abc	Enters the corresponding numbers (in numeric input fields) or characters (character input fields).
.	Inserts a decimal point (numeric input fields) or dot (character input fields) at the cursor position. Multiple decimal points are not allowed.
+/-	Changes the sign of a numeric parameter. In the case of an alphanumeric parameter, inserts a hyphen at the cursor position.
Unit keys	Selects a unit and thus determine the absolute value, or changes the unit, i.e. trigger a recalculation without changing the absolute value. The function depends on the time at which the UNIT key is used during parameter entry (see chapter 4.4.5, "Working with Units" , on page 73). For unit-free values, the X1 key is equivalent to ENTER. It confirms the previous entry and deactivates the input field.
_	Adds a blank in a character input field.

Keys	Description
*... #	Enters special characters. Toggles through the available characters if the key is pressed several times in a row.
A <-> a	Toggles between uppercase and lowercase characters.
A, B, C, D, E, F	Enters hexadecimal values. The letters assigned to the keys are automatically active when an entry field with a hexadecimal value is active.

INSERT

Toggles between insert and overwrite mode (see also [chapter 4.4.4, "Entering a Value"](#), on page 71).

BACKSPACE

Deletes the last character before the cursor position or the selected character sequence.

ENTER

Pressing the rotary knob has the same effect.

- Concludes the entry of dimensionless entries. For other entries, this key can be used instead of the default unit key. The new value is accepted.
- Confirms ("OK") and closes open input windows.
- In a dialog box, selects the default or focused button.
- In a dialog box, activates the edit mode for the focused area, if available.
- In a dialog box, activates or deactivates the selected option of the focused area, if the edit mode is active.
- Calls the next menu level.

2.1.6 Rotary Knob and Navigation Keys

The rotary knob and the arrow keys are alternative control elements for data variation and navigation in the graphical user interface.

**ROTARY KNOB**

The rotary knob has several functions:

- Increases (clockwise direction) or decreases (counter-clockwise direction) numeric values at a defined step width in editing mode
- Moves the cursor, e.g. to a function block in the block diagram
- Scrolls within lists, tables or tree views
- Acts like the ENTER key, when it is pressed.
- Shifts the selection bar within focused areas (e.g. lists), if the edit mode is activated.

Note: Turning or pressing the rotary knob is equivalent to pressing the UP and DOWN keys or the ENTER key in the keypad.

NAVIGATION KEYS

The navigation keys consist of 4 arrow keys which are used for navigation, alternatively to the rotary knob.

- | | |
|------------------|---|
| UP/ DOWN KEYS | The up and down arrow keys do the following: <ul style="list-style-type: none"> • In a numeric edit dialog box, increase or decrease the instrument parameter. • In a list, table, window or dialog box, scroll vertically. |
| LEFT/ RIGHT KEYS | The left and right arrow keys do the following: <ul style="list-style-type: none"> • In an alphanumeric edit dialog box, move the cursor forward and back. • In a list, table, window or dialog box, scroll horizontally. |

2.1.7 Front Panel Connectors

The RF and LF connectors and various additional interface connectors are located on the front panel.

SENSOR

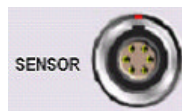

Connector for R&S NRP-Zxx sensors.

With the aid of the "User Correction" function, a table with correction values for external test assemblies can be automatically determined, e.g. for compensating the frequency response of cables.

The power sensors are connected by inserting the male connector. To disconnect hold the connector by its sleeve. Pulling on the sensor cable will not release the sensor connector.

See also [chapter 5.4.6.1, "NRP-Z Power Viewer"](#), on page 164.



LF

Output for internal LF Generator and monitoring signal (option R&S SMF-B20).

See also data sheet, [chapter 5.6, "LF Gen./Noise"](#), on page 235 and [chapter 5.7, "LF Output"](#), on page 247.



EXT 1 | EXT 2

Inputs for external modulation signals for AM, FM, Phase Modulation, ASK, FSK, and PSK (option R&S SMF-B20).



PULSE IN, PULSE OUT

Input/output for pulse generation

PULSE IN Input of external pulse signal or input for triggering the pulse generator (option R&S SMF-K23).

PULSE OUT Output of internal pulse signal generated by the internal pulse generator (option R&S SMF-K23).



EXT ALC

Input for detection voltage of an external level detector.



RF

Outputs for RF signal.

NOTICE! Maximum Input Levels. Do not overload the RF output. The maximum permissible back-feed is specified in the data sheet.



USB

USB (universal serial bus) interfaces of type A (host USB).

- Connection of peripherals such as mouse or keyboard
- Connection of memory stick for file transmission
- Firmware update

Note: Optionally, another USB interface type A (host) and a USB interface type B (device, for remote control) are available on the rear panel (option R&S SMF-B84).

See also [chapter 2.4.1, "Connecting USB Devices"](#), on page 32.

2.2 Rear Panel Tour

This section gives an overview of connectors on the rear panel of the instrument. Each connector is briefly described and a reference is given to the chapters containing detailed information. For technical data of the connectors refer to the data sheet.

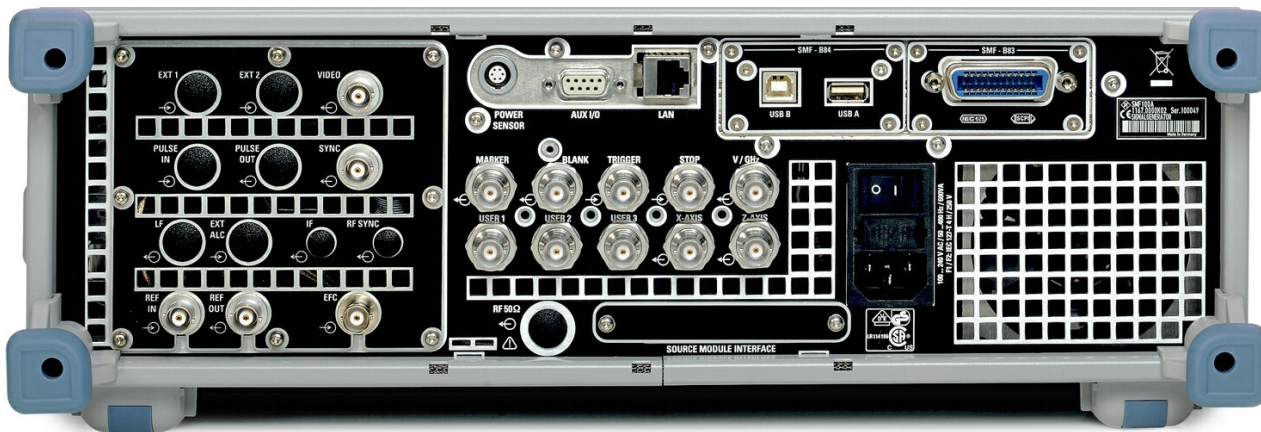

Fig. 2-2: Rear panel view

2.2.1 Description of the Connectors



EXT 1 | EXT 2

Inputs for external modulation signals for AM, FM, Phase Modulation, ASK, FSK, and PSK (option R&S SMF-B20).

The rear panel inputs are available only with option R&S SMF-B81.

This option is recommended for use of the instrument in a 19" rack. Installing the instrument in a 19" rack requires a rack adapter (refer to data sheet for Order No.).



VIDEO

Output of the external or internal pulse modulation signal (video signal).



SENSOR

Rear panel connector for R&S NRP-Zxx power sensors.



AUX I/O

Interface for direct control of additional external devices.



LAN CONNECTOR

Ethernet interface

- For integrating signal generators in a network
- Remote control of signal generator
- Remote access to the signal generator
- Firmware update

See also:

- [chapter 2.6, "Setting Up a Network \(LAN\) Connection"](#), on page 35
- [chapter 6.1.3, "LAN Interface"](#), on page 267



USB A, USB B

Universal serial bus interfaces available only with option R&S SMF-B84.

USB B Universal serial bus interface of type B (device USB)
Remote control of signal generator

USB A USB (universal serial bus) interfaces of type A (host).

- Connection of peripherals such as mouse and keyboard
- Connection of memory stick for file transmission

Two further USB interfaces of type A are available on the front panel.
See also [chapter 2.4.1, "Connecting USB Devices"](#), on page 32.

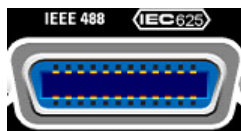

IEC 625/IEEE 488

IEC-bus (IEEE 488) interface for remote control of the instrument.

The GPIB interface is available only with option R&S SMF-B83.

See also [chapter A.1, "GPIB Bus Interface"](#), on page 533 and [chapter 6.1.6, "GPIB Interface \(IEC/IEEE Bus Interface\)"](#), on page 270.

Note: In order to avoid electromagnetic interference (EMI) caused by open lines, always terminate any connected IEC-bus cable with an instrument or a controller.

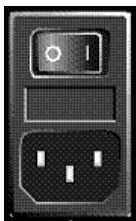

AC SUPPLY AND POWER SWITCH

When the R&S SMF is connected to the AC supply, it automatically sets itself to the correct range for the applied voltage (range: see type label). There is no need to set the voltage manually or change fuses.

The power switch can be set to two positions:

- 0
The instrument is disconnected from the mains.
- I
The instrument is power-supplied. It is either ready for operation (STANDBY) or in operating mode, depending on the position of the ON/STANDBY switch on the instrument front.

See also data sheet and [chapter 2.3.3, "Connecting the Instrument to the AC Supply"](#), on page 28.



RF OUT

Rear panel output for RF signal (option R&S SMF-B81).

This option is recommended for use of the instrument in a 19" rack. Installing the instrument in a 19" rack requires a rack adapter (refer to data sheet for Order No.).

NOTICE! Maximum Input Levels. Do not overload the RF output. The maximum permissible back-feed is specified in the data sheet.



EFC

Input for external EFC signal (external frequency control).



REF IN

Input for external reference signal.

See also [chapter 5.3.6, "Reference Oscillator"](#), on page 146.



REF OUT

Output of internal reference signal.

It can be adjusted whether the internal or the external signal is to be output.

See also [chapter 5.3.6, "Reference Oscillator"](#), on page 146.



MARKER

Output for user-programmable marker signal used for brightness control of an oscilloscope. This output becomes active when the sweep run has reached the marker.



BLANK

Output for triggering and blanking an oscilloscope or for PEN LIFT control of an XY recorder.



TRIGGER

Input for triggering the sweep in the "Extern Single" and "Extern Step" modes.

**STOP**

Input and output for stopping the sweep in all modes.

This connector is bidirectional:

- Used as an input, the sweep can be stopped by an external network analyzer.
- Used as an output, the generator can stop the sweep of an external network analyzer.

**V / GHz**

Output for supplying a voltage which is proportional to the frequency.

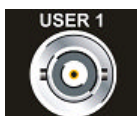
**USER 1 | USER 2 | USER 3**

Input/output for configurable signals for triggering and control.

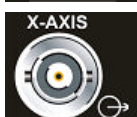
**X-AXIS**

Output for supplying a voltage ramp for the X deflection of an oscilloscope or an XY recorder.

**Z-AXIS**

Output for supplying a voltage pulse for the combined blanking and marker generation for network analyzers.

**PULSE IN**

Input of external pulse signal or input for triggering the pulse generator (option R&S SMF-K23).

The connector at the rear panel is available only with option R&S SMF-B81.

This option is recommended for use of the instrument in a 19" rack. Installing the instrument in a 19" rack requires a rack adapter (refer to data sheet for Order No.).

**PULSE OUT**

Output of internal pulse signal generated by the internal pulse generator (option R&S SMF-K23).

The connector at the rear panel is available only with option R&S SMF-B81.

This option is recommended for use of the instrument in a 19" rack. Installing the instrument in a 19" rack requires a rack adapter (refer to data sheet for Order No.).

**SYNC**

Output for internal SYNC signals for pulse modulation.

**LF**

Rear panel output for internal LF generator signal (option R&S SMF-B81).

This option is recommended for use of the instrument in a 19" rack. Installing the instrument in a 19" rack requires a rack adapter (refer to data sheet for Order No.).

**EXT ALC**

Input for detection voltage of an external level detector (requires option R&S SMF-B81).

This option is recommended for use of the instrument in a 19" rack. Installing the instrument in a 19" rack requires a rack adapter (refer to data sheet for Order No.).

2.3 Putting into Operation

This section describes the basic steps to be taken when setting up the R&S SMF for the first time.

WARNING

Risk of injury and instrument damage

The instrument must be used in an appropriate manner to prevent electric shock, fire, personal injury, or damage.

- Do not open the instrument casing.
 - Read and observe the "Basic Safety Instructions" at the beginning of this manual or on the documentation CD-ROM, in addition to the safety instructions in the following sections. Notice that the data sheet may specify additional operating conditions.
-

NOTICE

Risk of instrument damage

Note that the general safety instructions also contain information on operating conditions that will prevent damage to the instrument. The instrument's data sheet may contain additional operating conditions.

NOTICE

Risk of instrument damage during operation

An unsuitable operating site or test setup can cause damage to the instrument and to connected devices. Ensure the following operating conditions before you switch on the instrument:

- All fan openings are unobstructed and the airflow perforations are unimpeded. The minimum distance from the wall is 10 cm.
 - The instrument is dry and shows no sign of condensation.
 - The instrument is positioned as described in the following sections.
 - The ambient temperature does not exceed the range specified in the data sheet.
 - Signal levels at the input connectors are all within the specified ranges.
 - Signal outputs are correctly connected and are not overloaded.
-

NOTICE

Risk of electrostatic discharge

Protect the work area against electrostatic discharge to avoid damage to electronic components in the modules. For details, refer to the safety instructions at the beginning of this manual.



EMI impact on measurement results

Electromagnetic interference (EMI) can affect the measurement results. To avoid any impact, make sure that the following conditions are met:

- Use suitable double-shielded cables.
- Do not use USB connecting cables exceeding 1 m in length.
- Use only USB devices that remain within the permissible EMI limits.
- Always terminate any connected IEC-bus cables with an instrument or controller.

Outputs and lines have to be terminated properly with 50 Ohms.

For digital interfaces only the cable R&S SMF-Z6 is permitted for connection. The associated cable is available under part number 1415.0201.02.

2.3.1 Unpacking and Checking the Instrument

To remove the instrument from its packaging and check the equipment for completeness proceed as follows:

1. Pull off the polyethylene protection pads from the instrument's rear feet and then carefully remove the pads from the instrument handles at the front.
2. Pull off the corrugated cardboard cover that protects the rear of the instrument.
3. Carefully unthread the corrugated cardboard cover at the front that protects the instrument handles and remove it.
4. Check the equipment for completeness using the delivery note and the accessory lists for the various items.
5. Check the instrument for any damage. If there is damage, immediately contact the carrier who delivered the instrument. Make sure not to discard the box and packing material.



Packing material

Retain the original packing material. If the instrument needs to be transported or shipped at a later date, you can use the material to protect the control elements and connectors.

2.3.2 Placing or Mounting the Instrument

The R&S SMF is designed for use under laboratory conditions, either on a bench top or in a rack using a rack adapter kit (order number see data sheet).

Bench Top Operation

If the R&S SMF is operated on a bench top, the surface should be flat. The instrument can be used in horizontal position, standing on its feet, or with the support feet on the bottom extended.

CAUTION**Risk of injury at the operating site**

The feet may fold in if they are not folded out completely or if the instrument is shifted. This may cause damage or injury.

- Fold the feet completely in or completely out to ensure stability of the instrument. Never shift the instrument when the feet are folded out.
- When the feet are folded out, do not work under the instrument or place anything underneath.
- The feet can break if they are overloaded. The overall load on the folded-out feet must not exceed 500 N.

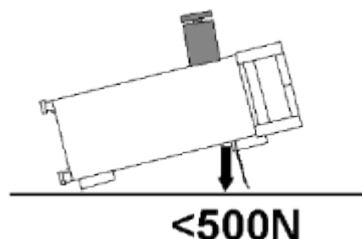
**Rackmounting**

The R&S SMF can be installed in a rack using a rack adapter kit (Order No. see data sheet). The installation instructions are part of the adapter kit.

NOTICE**Risk of instrument damage in a rack**

An insufficient airflow can cause the instrument to overheat, which may disturb the operation and even cause damage.

Make sure that all fan openings are unobstructed, that the airflow perforations are unimpeded, and that the minimum distance from the wall is 10 cm.

2.3.3 Connecting the Instrument to the AC Supply

The R&S SMF is automatically adapted to the AC voltage supplied. There is no need to set the voltage manually or change fuses. The [AC SUPPLY AND POWER SWITCH](#) is at the rear of the unit.

- ▶ Connect the instrument to the AC power source using the AC power cable delivered with the instrument.

Note: The instrument is in compliance with safety class EN61010-1. Connect the instrument only to a socket with earthing contact.

2.3.4 Starting the Instrument



Switching off the AC power

You can leave the AC power on permanently to preserve your last instrument settings. Switching off is required only if the instrument must be completely disconnected from all power supplies.

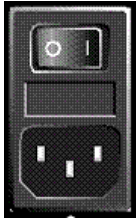

Starting up instruments with power switch

1. [Connect the instrument to the AC supply.](#)
2. To turn the power on, press the main power switch to position I (On).
After power-up, the instrument is in [standby or ready state](#), depending on the state of the ON/STANDBY key at the front panel of the instrument when the instrument was switched off for the last time.
3. In case the instrument is in standby mode, i.e. the yellow LED is on, press the ON/STANDBY key to switch the instrument to ready state.

2.3.4.1 Standby and Ready state

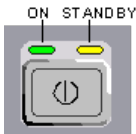

The ON/STANDBY key is located in the bottom left corner of the front panel.

Switching between standby and ready state

- ▶ Press the ON/STANDBY key briefly to switch the instrument from the standby to ready state or vice versa.

In ready state, the left, green LED is on. The instrument is ready for operation. All modules are power-supplied and the R&S SMF initiates its [startup procedure](#).

In standby state, the right, yellow LED is on. The standby power only supplies the power switch circuits and the oven-controlled crystal oscillator to keep it at its operating temperature. In this state it is safe to switch off the AC power and disconnect the instrument from the power supply.

2.3.4.2 Start Display and Booting

The instrument boots the operating system, starts the instrument firmware and automatically performs a selftest. If the previous session was terminated regularly, the instrument uses the last setup with the relevant instrument settings.

Once the startup procedure has been terminated, the block diagram opened in the previous session is displayed and the instrument is ready for operation.



Use the PRESET key to return the instrument to its definite reset/preset state, if the current setup is not anymore relevant.

To customize the start settings, use the "File" dialog.



Rebooting the instrument

Press the STANDBY key for approx. 5 s. to reboot the instrument, if the software stops unexpectedly.

2.3.4.3 Function Check

The signal generator automatically monitors the main functions when the instrument is switched on and continuously during operation.

A detected fault is indicated by a "ERROR" message displayed in the info line together with a brief error description. For in-depth identification of the error, press the INFO key. In response, a description of the error(s) is displayed.

For more information, refer to [chapter 9, "Error Messages"](#), on page 527.

Additionally to the automatic monitoring, the R&S SMF offers the following capabilities to ensure correct functioning:

- **Internal Adjustments**
Press the SETUP key and select "System > Internal Adjustments" to access the dialog for performing and configuring of the adjustments settings. A maximum level accuracy can be obtained, for instance.
- **Selftest**
A selftest is provided for service purposes. The selftest is a protected test procedure, which can be accessed if protection level 1 is disabled.

2.3.4.4 Default Settings

When the instrument is switched on, it is not the preset state that is active, but rather the instrument state that was set before the instrument was switched off. It is also recommended that you use the PRESET key to return the instrument to its defined preset state every time a new configuration is required or the current setup is not anymore relevant.

The R&S SMF offers a two-stage preset concept:

- **Preset the instrument to a predefined state**
The PRESET key calls up a defined instrument setup. All parameters and switching states are preset (also those of inactive operating modes). The default instrument settings provide a reproducible initial basis for all other settings. However, functions that concern the integration of the instrument into a measurement setup are not changed, e.g. GPIB bus address or reference oscillator source settings.
- **Preset the instrument to its factory settings**
The instrument can also be forced to load its default factory settings. To access the corresponding dialog box, press the SETUP key and select the "Factory Preset". For more information and an overview of the settings affected by the factory preset function, see [chapter 5.2.3.17, "Factory Preset"](#), on page 111.

Overview of the Most Important Preset States

The following list gives an overview of the presets for the most important generator settings. The other presets can be found in the preset tables of the individual menus and the information accompanying the remote commands.

- "RF frequency" = 1 GHz
- "RF level" RF output switched off
- "Offsets" = 0
- "Modulations State" = Off
- Uninterrupted level settings are switched off
"Level Attenuator Mode" = AUTO
- Internal level control "Level ALC" = AUTO
- User correction "Level Ucor" = OFF
- "LF output State" = Off
- "Sweep State" = Off
- "List mode State" = Off

Settings that are not affected by the PRESET key

- Reference frequency settings ("Ref Oscillator" menu)
- Power on settings ("Level/EMF" menu)
- Network settings ("Setup" menu)
- GPIB address ("Setup" menu)
- *IDN? Identification and emulation ("Setup" menu)
- Password and settings protected by passwords ("Setup" menu)
- Start/Stop Gui Update ("Setup" menu)
- Display and keyboard settings ("Setup" menu)



User-defined instrument states can be stored and called up in the "File" dialog.

2.3.5 Shutting Down the Instrument

To shut down the R&S SMF, proceed as described below.

NOTICE**Risk of losing data**

If you switch off the running instrument using the rear panel switch or by disconnecting the power cord, the instrument loses its current settings. Furthermore, program data may be lost.

Press the ON/STANDBY key first to shut down the application properly.

1. Press the ON/STANDBY key to save the current setup, shut down the operating system and set the instrument to standby state.
The yellow LED must be on.
2. To switch off the power, press the main power switch to position 0 (Off).
None of the front-panel LEDs should be on.

2.3.6 Power Fuses

The R&S SMF is fully fused by two fuses IEC127-T4H/250 V.

The fuses are accommodated in the fuse holders next to the power connector. Use only fuses of the mentioned type.

WARNING**Shock hazard**

Before replacing a fuse, make sure that the instrument is switched off and disconnected from all power supplies.

Always use fuses supplied by Rohde & Schwarz as spare parts, or fuses of the same type and rating.

2.4 Connecting External Accessories

The equivalent USB ports on the front and/or rear panel of the R&S SMF can be used to connect a variety of accessories.

In addition the instrument provides interfaces for network integration (see [chapter 2.6, "Setting Up a Network \(LAN\) Connection"](#), on page 35).

2.4.1 Connecting USB Devices

The USB interfaces on the front and (optionally) rear panels of the R&S SMF allow you to connect USB devices directly to the instrument. This number can be increased as

necessary by using USB hubs. Due to the large number of available USB devices, there is almost no limit to the expansions that are possible with the R&S SMF.

The following list shows various USB devices that can be useful:

- Memory stick for easy transfer of data to/from a computer (e.g. firmware updates)
- CD-ROM drives for easy installation of firmware applications
- Keyboard or mouse to simplify the entry of data, comments, file names, etc.
- Power sensors, e.g. of the NRP Zxy family

Installing USB devices is easy under Linux, because all USB devices are plug&play. After a device is connected to the USB interface, the operating system automatically searches for a suitable device driver.

If Linux does not find a suitable driver, it will prompt you to specify a directory that contains the driver software. If the driver software is on a CD, connect a USB CD-ROM drive to the instrument before proceeding.

When a USB device is subsequently disconnected from the R&S SMF, the operating system immediately detects the change in hardware configuration and deactivates the corresponding driver.

All USB devices can be connected to or disconnected from the instrument during operation.

Connecting a memory stick or CD-ROM drive

If installation of a memory stick or CD-ROM drive is successful, the operating system informs you that the device is ready to use. The device is made available as a new drive (`/usb`). The name of the drive is manufacturer-dependent.

Connecting a keyboard

The keyboard is detected automatically when it is connected. The default keyboard layout is English – US.

Use the "Setup > Keyboard Settings" dialog to configure the keyboard properties.

Connecting a mouse

The mouse is detected automatically when it is connected.

2.5 Linux Operating System

The instrument contains the Linux operating system. To ensure that the instrument software functions properly, certain rules must be adhered to concerning the operating system.

NOTICE**Risk of causing instrument unusability**

The instrument is equipped with the Linux operating system. Additional software can therefore be installed on the instrument. The use and installation of additional software may impair instrument function. Thus, run only programs that Rohde & Schwarz has tested for compatibility with the instrument software.

The drivers and programs used on the instrument under Linux have been adapted to the instrument. Existing instrument software must always be modified using only update software released by Rohde & Schwarz.

The configuration of the operating system is optimally adapted to signal generator functions in the factory. Changes in the system setup are only required when peripherals like keyboard are installed or if the network configuration does not comply with the default settings (see [chapter 2.6.1, "Connecting the Instrument to the Network"](#), on page 35). After the R&S SMF is started, the operating system boots and the instrument firmware is started automatically.

**Accessing Operating System**

The operating system cannot be accessed.

All necessary system settings can be made in the "Setup" dialog.

The R&S SMF provides a internal CompactFlash™ Card, it does not contain a disk drive. The CompactFlash™ Card holds the firmware and the stored data. However, data transfer is only possible via a memory stick connected to a USB interface. The memory stick and the CompactFlash™ Card are accessed via the "File Manager".

Accessing the File System

The instrument also supports two standard methods to access the file system form a remote client:

- FTP (file transfer protocol)
- File sharing according to the SAMBA/SMB (server message block) protocol.

Both methods allow the access to the folder `/var/user/share`.

**Default password**

The FTP and SAMBA file access use the user "instrument" with default password "instrument".

It is highly recommended to change this password in the [Setup > Security > Change User Password](#) dialog before connecting the instrument to the network!

Screen saver

A screen saver can be activated in the R&S SMF. When active, the display is shut off when no entries via front panel, external mouse or external keyboard are made for a period of time. The screen saver prolongs the life time of the display.

Use the "Setup > Display Settings" dialog to switch on or off the screen saver and to adjust the screen saver settings.

2.6 Setting Up a Network (LAN) Connection

The R&S SMF is equipped with a network interface and can be connected to an Ethernet LAN (local area network). Provided the appropriate rights have been assigned by the network administrator and the Linux firewall configuration is adapted accordingly, the interface can be used, for example:

- To transfer data between a controller and the tester, e.g. in order to run a remote control program.
See [chapter 6, "Remote Control Basics"](#), on page 265.
- To access or control the measurement from a remote computer using the "Remote Desktop" application, the Ultr@VNC program (or a similar tool)
- To connect external network devices (e.g. printers)
- To transfer data from a remote computer and back, e.g. using network folders

This section describes how to configure the LAN interface. It includes the following topics:

- [chapter 2.6.1, "Connecting the Instrument to the Network"](#), on page 35
- [chapter 2.6.2, "Assigning the IP Address"](#), on page 36



Accessing Operating System

The operating system cannot be accessed.

All necessary system settings can be made in the "Setup" dialog.

2.6.1 Connecting the Instrument to the Network

There are two methods to establish a LAN connection to the instrument:

- A non-dedicated network (Ethernet) connection from the instrument to an existing network made with an ordinary RJ-45 network cable. The instrument is assigned an IP address and can coexist with a computer and with other hosts on the same network.
- A dedicated network connection (Point-to-point connection) between the instrument and a single computer made with a (crossover) RJ-45 network cable. The computer must be equipped with a network adapter and is directly connected to the instrument. The use of hubs, switches, or gateways is not required, however, data transfer is still performed using the TCP/IP protocol.

In both cases, an IP address has to be assigned to the instrument and the computer, see [chapter 2.6.2, "Assigning the IP Address"](#), on page 36.

The R&S SMF uses the IP addresses 192.168.xxx.yyy for this purposes, where xxx and yyy may take values between 1...254; the subnet mask is always 255.255.255.0.

NOTICE**Risk of network failure**

Before connecting the instrument to the network or configuring the network, consult your network administrator. Errors may affect the entire network.

- ▶ To establish a non-dedicated network connection, connect a commercial RJ-45 cable to one of the LAN ports.
To establish a dedicated connection, connect a (crossover) RJ-45 cable between the instrument and a single PC.

If the instrument is connected to the LAN, the operating system automatically detects the network connection and activates the required drivers.

The network card can be operated with a 10/100 Mbps Ethernet IEEE 802.3u interface.

2.6.2 Assigning the IP Address

Depending on the network capacities, the TCP/IP address information for the instrument can be obtained in different ways.

- If the network supports dynamic TCP/IP configuration using the Dynamic Host Configuration Protocol (DHCP), all address information can be assigned automatically.
- If the network does not support DHCP, the instrument tries to obtain the IP address via Zeroconf (APIA) protocol. If this attempt does not succeed or if the instrument is set to use alternate TCP/IP configuration, the addresses must be set manually.

By default, the instrument is configured to use dynamic TCP/IP configuration and obtain all address information automatically. This means that it is safe to establish a physical connection to the LAN without any previous instrument configuration.

NOTICE**Risk of network errors**

Connection errors can affect the entire network. If your network does not support DHCP, or if you choose to disable dynamic TCP/IP configuration, you must assign valid address information before connecting the instrument to the LAN. Contact your network administrator to obtain a valid IP address.

Assigning the IP address on the instrument

1. Press the SETUP key and select the "Network Settings" dialog.

2. Set the "Address Mode" to Static.
3. Select the "IP Address" and enter the IP address, for example *192.168.0.1*.. The IP address consists of four number blocks separated by dots. Every block contains 3 numbers in maximum.
4. Select the "Subnet Mask" and enter the subnet mask, for example *255.255.255.0*. The subnet mask consists of four number blocks separated by dots. Every block contains 3 numbers in maximum.

Assigning the IP address manually on a PC

1. Obtain the IP address and subnet mask for the R&S SMF and the IP address for the local default gateway from your network administrator. If necessary, also obtain the name of your DNS domain and the IP addresses of the DNS and WINS servers on your network. If you use more than one LAN connector, you need separate address information for each connector.
2. Press the "Windows" key to access the operating system.
3. Open the "Control Panel" by selecting "Start > Settings > Control Panel".
4. Select "Network Connections".
5. Right-click "Local Area Connection" and select "Properties" from the context-sensitive menu, or click "Local Area Connection" and then "File > Properties".
6. On the "General" tab, click "Internet Protocol (TCP/IP)" and then select "Properties".
7. Select "Use the following IP address" and enter the address information as obtained from the network administrator.
8. If necessary, you can also select "Use the following DNS server addresses" and enter your own DNS addresses.

For more information refer to the Windows XP Help.

2.6.3 Using Computer Names

Alternatively to the IP address, each PC or instrument connected in a LAN can be accessed via an unambiguous computer name. Each instrument is delivered with an assigned computer name, but this name can be changed.

Querying and changing a computer name

1. Press the "Setup" key and select "Network Settings".
The computer name is displayed under "Hostname".
2. Press the "Setup" key, select "Protection" and enable the "Protection Level 1".
The parameter "Hostname" in the "Network Settings" dialog is now enabled for configuration.

3. Change the "Hostname".

2.7 Remote Access via an External Controller

The R&S SMF can be remote accessed from a remote computer (external controller) via a network link. This allows convenient operation of the instrument from the desktop although the instrument is integrated in a rack somewhere else.



For an overview of the instrument's operating concept and the different ways to control and operate the instrument, see [chapter 3.1, "Brief Introduction to the Instrument's Concept"](#), on page 45.

There are different ways to establish a remote access connection to the signal generator but all of them require an established LAN connection between the instrument and the remote computer. The simplest way to remote access the instrument is to use a Web browser, such as Windows Internet Explorer or Mozilla Firefox for instance. Alternatively a remote access via a special application can be used.

The free-of-charge program Ultr@VNC for PCs with Linux/Unix or Windows operating system is available for setting up the remote access connection. Using this application requires additional installation.

See the following table for an overview of the different ways to establish a remote access connection to the signal generator.

Table 2-1: Remote access via an external computer

Remote access via	LAN connection	Installation of the additional application	
		on the instrument	on the remote computer
Web Browser e.g. Windows Internet Explorer or Mozilla Firefox see chapter 2.7.1, "Using a Web Browser for Remote Access" , on page 39	required	no	no
Ultr@VNC for PCs with Linux/Unix or Windows operating system see chapter 2.7.2, "Remote Access via Ultr@VNC" , on page 40	required	required	VNC Viewer required

When the connection is set up with Ultr@VNC, direct control on the instrument is possible while remote access is established.

For return to direct operation on the instrument, the connection must be cut. After cutting the connection, it is still enabled and can be established again any time. The connection is disabled only after deactivation of the program.

This section gives an information on how to use the Web browser for remote access, how to install the applications for remote access and how to establish the connection between

the instrument and an external computer with Windows operating system. Remote access via an external computer with Linux/Unix operating system is performed accordingly.



Default password

Remote-access and file access require the user "instrument" with default password "instrument".

NOTICE

Changing the default user and security passwords

It is highly recommended to change the default user and security passwords in the menu "Setup > Security" before connecting the instrument to the network (see section [chapter 5.2.3.15, "Security"](#), on page 107).

2.7.1 Using a Web Browser for Remote Access

The instrument can be remote-accessed via any Web browser, like Windows Internet Explorer or Mozilla Firefox for instance.

To remote access the instrument via Web browser:

1. Connect the instrument and the remote computer to a LAN, see [chapter 2.6.1, "Connecting the Instrument to the Network"](#), on page 35.
2. Instal the Java Runtime Environment JRE on the remote computer.
3. Type the instruments' IP address in the address field of the Web browser on your PC, e.g. *http://10.111.11.1*

The "VNC Authentication" screen appears.

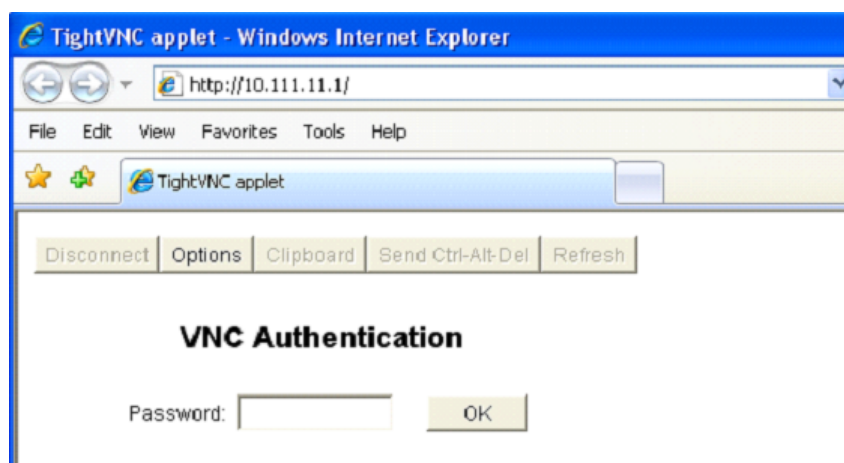

4. Enter the password and select "OK".

The default password is "instrument".

After the connection is established, the current signal generator screen with the block diagram is displayed and the instrument can be remote-accessed from the remote computer.

2.7.2 Remote Access via Ultr@VNC

Ultr@VNC is an application which can be used to access and control the instrument from a remote computer through a LAN connection. The program is included in operating system Linux/Unix. It is available as a free-of-charge download on the internet for operating system Window XP (<http://www.uvnc.com/download/index.html>) and on the instrument's CD-ROM.

NOTICE

Risk of Unauthorized Access

If the VNC application is enabled on the instrument, any user in the network who knows the computer name and login data can access it. To prevent this, make sure that the VNC server service on the instrument is disabled.

Setting up a VNC connection

1. Connect the instrument and the remote computer to a LAN, see [chapter 2.6.1, "Connecting the Instrument to the Network"](#), on page 35.
2. [Install the Ultr@VNC application](#) and enable it on the instrument.
3. In the ICF firewall, enable communication on the network via Ultr@VNC program.
4. Install the VNC Viewer on the remote computer with Windows operating system, see ["Installing the VNC Viewer on a Windows PC"](#) on page 42.
5. Set up the VNC connection between the instrument and:
 - a) the remote computer with Linux/Unix operating system, see ["Setting up the VNC connection on the Linux/Unix remote computer"](#) on page 42;
 - b) the remote computer with Windows operating system, see ["Setting up the VNC connection on the Windows remote computer"](#) on page 43.



Enabled Direct Control

The direct control of the instrument is not disabled and the instrument can be controlled from the front panel and via the remote computer alternately.

Installing the Ultr@VNC application

1. Download the program from the internet and copy it to a directory that can be accessed.
2. On the instrument, shut down firmware using the ALT+F4 key combination.

3. Double click on the setup file to start the installation.
The setup wizard leads through the installation. This description focus only on the relevant settings.
 - a) Select installation of all components.

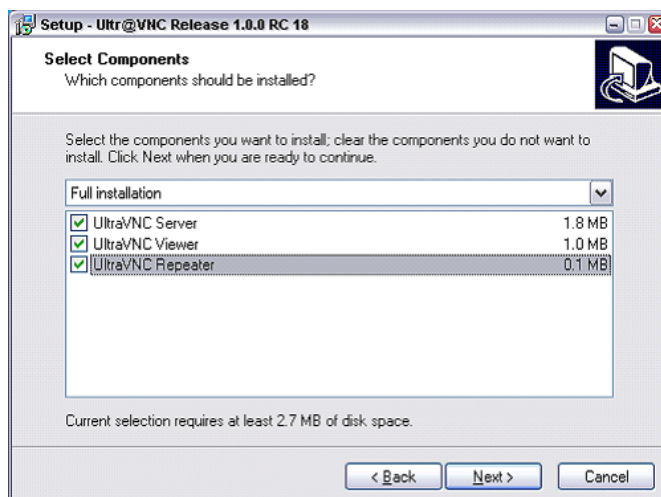

- b) In the "Additional Task Panel", enable all entries.

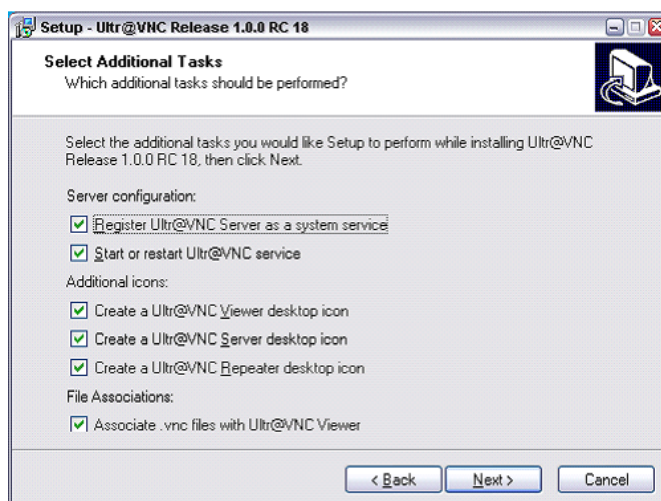

A successful installation is indicated by a message.

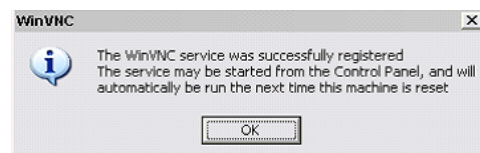

At the same time a warning is displayed stating that a password must be set.

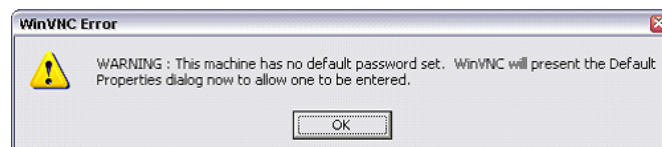

4. Select "OK".

The "Default Local System Properties" panel opens.

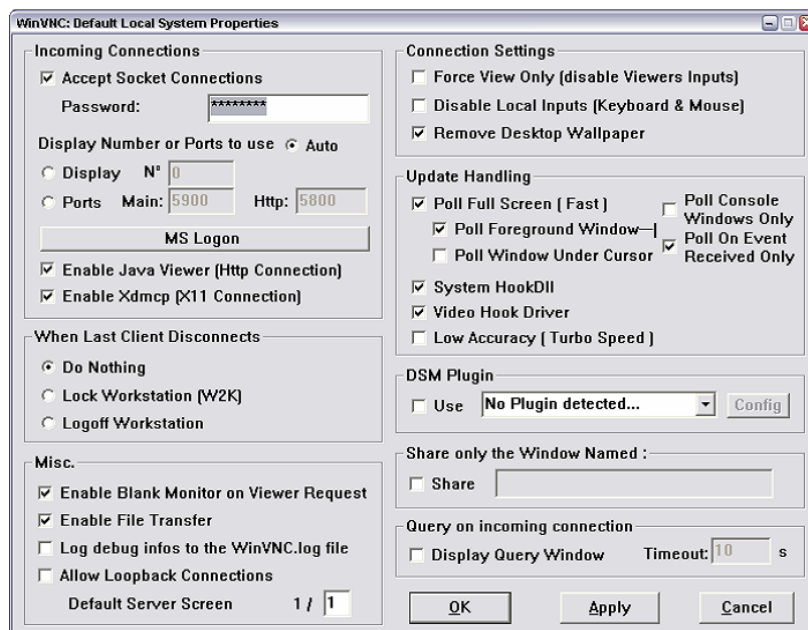

5. Enter a password with a length of at least five digits.
This password is used on the remote computer to access the instrument. Other settings may be changed according to the user-specific security requirements.

After the installation the Ultr@VNC program is automatically started together with the operating system. On mouse over, the IP address of the instrument is indicated. This IP address and the user-defined password are the prerequisites to enable remote access on the remote computer. Terminated connection is indicated by changed icon color.

Installing the VNC Viewer on a Windows PC

1. Download the Ultr@VNC program from internet and follow the installation instructions.
Only the program component VNC Viewer is required.

Note: The VNC Viewer program is included in the download for the installation of the Ultr@VNC program on the signal generator if "Full installation" was selected in the "Select Component" panel. In this case, the program `ultr@vncviewer.exe` can be copied to the Windows PC.

2. Install VNC Viewer program component on the remote computer.

Setting up the VNC connection on the Linux/Unix remote computer

The VNC program is available per default for Linux/Unix operating systems.

1. Start a Web browser on the remote computer and enter the IP address of the instrument.
2. Enter the following address:

vnc://<IP-address of the instrument>, e.g. vnc://192.168.1.1.

A dialog is opened and the password for the remote VNC connection is requested.

3. Enter the password as defined in the "Default Local System Properties" panel of the Ultr@VNC program and select "Log On".

The connection is established, the instrument is remote accessed and the current signal generator screen with the block diagram is displayed. The individual functions are operated using the mouse and keyboard.

In contrast to remote access via Remote Desktop, the direct control of the instrument is not disabled and the instrument can be controlled from the front panel and via the remote computer alternately.

Setting up the VNC connection on the Windows remote computer

1. Start VNC Viewer program component on the PC, select "VNC Server" and enter IP address of the instrument.

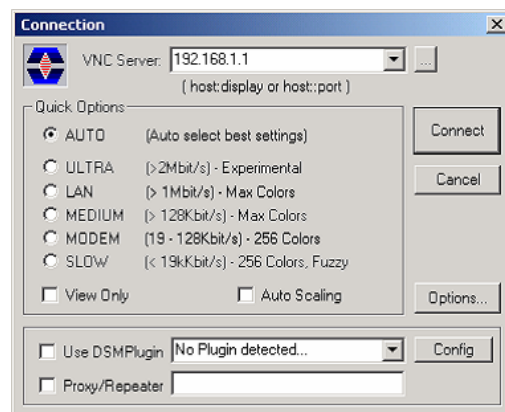

2. To initialize the connection, select "Connect".

A message requesting the password appears.

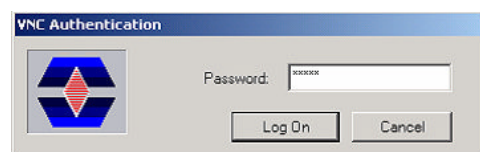

3. Enter the password as defined in the "Default Local System Properties" panel of the Ultr@VNC program and select "Log On".

The connection is established, the instrument is remote accessed and the current signal generator screen with the block diagram is displayed. The individual functions are operated using the mouse and keyboard.



Enabled Direct Control

The direct control of the instrument is not disabled and the instrument can be controlled from the front panel and via the remote computer alternately.

Terminating VNC Connection

The remote access via VNC connection can be terminated either on the R&S SMF or on the external PC. Terminating the connection does not disable it. It can be established again any time. See the notice above concerning unauthorized access due to VNC connection!

1. Terminate the connection on the R&S SMF
 - a) Press the "Windows" key to access the operating system.
 - b) Right-click on the VNC icon on the task bar and select "Kill all clients".
2. To terminate the connection on the external Linux/Unix PC, close the internet browser or close the signal generator window.
3. To terminate the connection on the external Windows PC, close the VNC Viewer program.

The connection is terminated. The color of the VNC icon in the status bar of the instrument changes.

A message on the external PC indicates the disconnection.

Disabling Remote Access via Ultr@VNC

The VNC connection can be disabled by removing the program on the instrument or by deactivating the VNC Server service.

1. Remove the VNC program
 - a) Press the "Windows" key to access the operating system and open the "Add or Remove Programs" by selecting "Start > Settings > Control Panel > Add or Remove Programs".
 - b) Remove the VNC program.
2. Deactivate the VNC Server service
 - a) Press the "Windows" key to access the operating system and open the "Services" by selecting "Start > Settings > Control Panel > Services".
 - b) Deactivate the VNC Server service.

The connection is disabled, the VNC icon disappears from the task bar of the instrument.

3 Getting Started

This section helps you to get familiar with the R&S SMF and provides an introduction to the general concept of the instrument with a sample of the possible application fields as well as a description of the main blocks in the signal generation flow.

This section also explains the operating concept in general and includes a brief introduction to operation by a step-by-step description of the configuration. The example is intended to provide a quick overview of the settings provided. No additional equipment is required.

3.1 Brief Introduction to the Instrument's Concept

The **operating concept** of the R&S SMF employs the following three ways of instrument control:

- Manual operation
- Remote control
- Remote access

Manual Operation

The R&S SMF can be entirely operated from the front panel. Peripherals such as mouse or keyboard can be connected but are not essential.

The R&S SMF is equipped with an intuitive user interface. The central element of the display is the block diagram that shows the signal flow and processing from the left on the display to most right, i.e. the generated signal can be seen at a glance.

Each block represents a functional unit of the instrument. Thus the user always knows the position at which a parameter has an effect in the signal flow. The main settings of a block are indicated in the block. The interconnection of employed inputs and outputs is also shown. The user is thus always informed about the connection of inputs and outputs in the signal flow and where they can be configured. A window is opened for each menu where parameters can be set. When the window is opened, an entry is made in the "Winbar" below the display. All open menus are of equal priority (not modal) and can be accessed any time.

The block diagram in the figure below shows a fully equipped instrument.

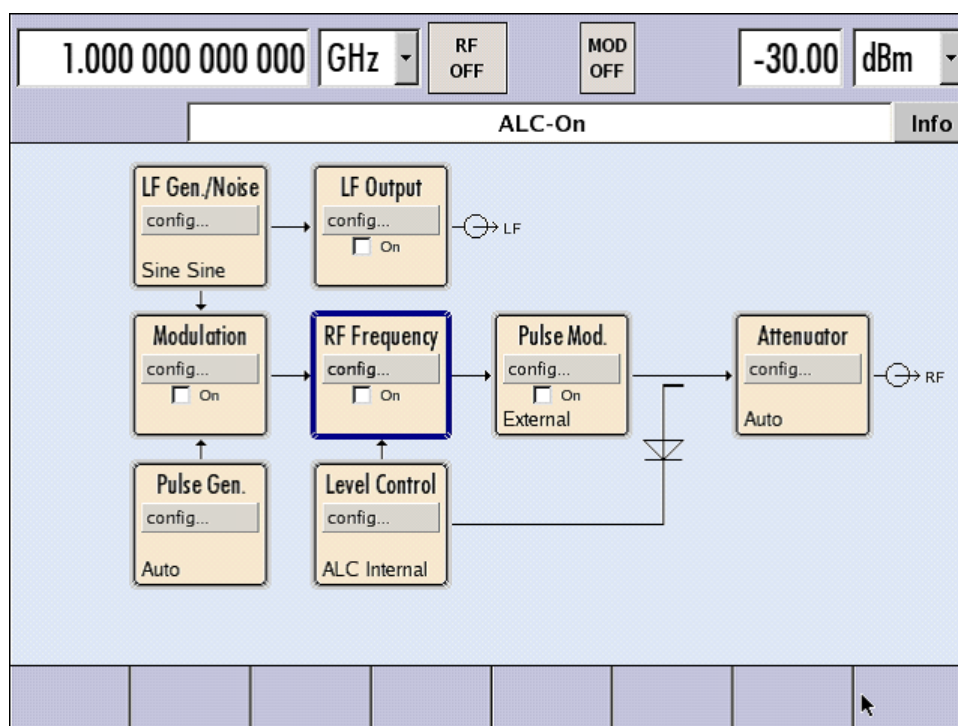

Fig. 3-1: Block diagram of a fully equipped R&S Microwave Signal Generator

With the aid of the rotary knob, the user can navigate in the block diagram and the dialogs, and can operate the instrument with one hand. The cursor is moved line by line through the block diagram or dialog. Turning the button clockwise advances the cursor. The selected block can be activated or deactivated with the TOGGLE key. Active blocks are highlighted by a colored background.

The instrument comprises a comprehensive info and help system. Context-sensitive help can be called any time with the HELP (F1) key. The help system indicates the currently selected parameter and offers additional services such as cross references, index and contents. The content of the help system corresponds to the operating manual of the instrument.

Warning and conflict messages caused by incorrect operation as well as further information are displayed in the "Info" line. A complete list of existing conflicts is displayed when the INFO (CTRL+I) key is pressed. Additional information on entries can be requested from the help system. The history function permits display of all messages.

Assistants simplify the completion of tables. After data entry in the assistant, the table is modified only after the "Accept" button has been pressed. Pressing the "Accept" button also stores the assistant data.

For an introduction into the manual operating of the instrument, detailed operating instructions and an overview of menus refer to [chapter 4, "Manual Operation"](#), on page 59.

For an in-depth description of the dialog boxes and the instrument functions refer to section [chapter 5.1, "Overview of Instrument Functions"](#), on page 87.

Remote Control

Remote control is an operation of the instrument by means of remote control commands or programs that automatize repeating settings. The instrument is connected to a computer running the program.

This way of operation and the instructions how to set up a connection for remote control are described in the [chapter 6, "Remote Control Basics"](#), on page 265. The description of the remote control commands is provided in [chapter 7, "Remote Control Commands"](#), on page 305.

Remote Access

Remote access is the operating of the instrument from a remote computer. Both the R&S SMF and the computer are connected in a LAN.

Remote access in contrast to **remote control** does not use remote-control commands but a separate software which is installed on the remote computer. After its start, the software simulates the user interface of the instrument. The instrument can thus be operated from the remote computer as on the unit itself. The individual functions are operated using the mouse and keyboard. Specific instrument functions can be executed using specific key combinations on the keyboard or a front panel key emulation that can be operated with the mouse.

This way of operation and the instructions how to set up a connection for remote access are described in [chapter 2.7, "Remote Access via an External Controller"](#), on page 38.

3.2 Application Field of the Instrument

The main field of application of the R&S SMF is the generation of microwave signals with very high spectral purity. The signals can be generated with a set frequency and level (CW mode), based on a list with predefined frequency/level pairs (List mode), or as a sweep with corresponding parameters (Sweep mode).

The RF signal can also be generated in modulated form. Option R&S SMF-B20 provides two internal LF generators, a noise generator and two external modulation inputs EXT 1 and EXT 2 at the front of the instrument which are available as the source for analog and/or digital modulations. Option R&S SMF-K23 provides an internal pulse generator.

3.3 Description of Individual Diagram Blocks



Up-to-date information is available at R&S SMF homepage on the internet <http://www2.rohde-schwarz.com/product/smf100a.html>).

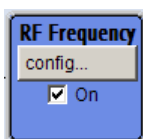

RF Frequency block

In this block, the RF frequency settings are performed.

RF settings include:

- RF frequency and phase settings
- Frequency sweep settings including sweep markers
- List mode settings
- Reference oscillator settings

Note: Numeric values for frequency are entered best and quickest with the aid of the **FREQ** key.

Use the **RF ON/OFF** key to switch the RF output on or off.

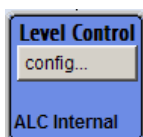

Level Control block

In this block, the RF level settings are performed.

RF level settings include:

- RF level settings
- RF level sweep settings including sweep markers
- Automatic level control
- NRP-Z Power Viewer using power sensors
- NRP-Z Power and Pulse Data Analysis using power sensors
- User Correction

Note: Numeric values for the level are entered best and quickest with the aid of the **LEVEL** key.

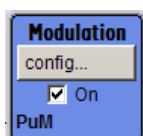

Modulation block

In this block, the modulation settings are performed. The **MOD ON/OFF** key switches the active modulation(s) on/off.

The external inputs **EXT 1** and **EXT 2** at the front of the instrument are provided for external amplitude, frequency, phase, and digital modulation (ASK, FSK, PSK).

Pulse modulation is available via the internal standard pulse generator. The external pulse modulation is available via the **PULSE IN** connector at the front of the instrument. The connector can be used as trigger input for internal pulse modulation. The external (and internal) pulse signal is output at the **VIDEO** connector at the back of the instrument.

Internal Pulse Modulation with extended features, e.g. generation of double pulse, requires option R&S SMF-K23, Pulse Generator. The pulse signal is output at the **PULSE OUT** connector at the front of the instrument. Narrow pulse modulation is provided by option R&S SMF-K3, and pulse train by option R&S SMF-K27.

Note: For an overview of the modulation modes that can be simultaneously used, refer to the data sheet or to "[Simultaneous Operation of Several Modulations or Other Operating Modes](#)" on page 218.

The status display in the block shows the active modulation(s).

Use the **TOGGLE ON/OFF** key to switch the modulation on or off.

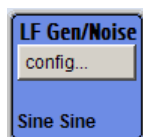

LF Gen./Noise block

In this block, two internal LF generators and a noise generator which can be used as internal modulation sources for analog modulations (amplitude modulation, frequency modulation, phase modulation) are configured. The LF/noise generators can also be used as the signal source for the LF output at the rear of the instrument.

The LF frequency sweep is also configured in this block.

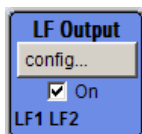

LF Output block

In this block, the LF output and the LF level sweep are configured.

The internal LF generators, the noise generator, or the external inputs EXT 1 and EXT 2 can be selected as source for the LF output.

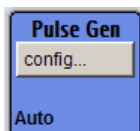

Pulse Gen. block

In this block, the settings for the internal pulse generator can be performed.

The pulse generator provides single and double pulse modulation with selectable pulse widths and periods. The signal is output at the PULSE OUT connector.

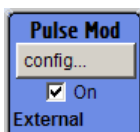

Pulse Mod. block

In this block, the narrow pulse modulation is activated and configured. Narrow pulse modulation requires option R&S SMF-K3.

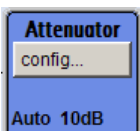

Attenuator block

In this block, the attenuator settings for the RF signal are performed.



SMZxxx block

By connecting an R&S SMZ75/90/110 Frequency Multiplier, the R&S SMF indicates a separate block for the frequency multiplier. The block shows the model of the frequency multiplier and its associated frequency range.

The model of the multiplier is differentiated in the header of the block:

- "SMZ-BxxxE" with electrical level control

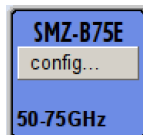

- "SMZ-BxxxM" with a mechanical level control



In models with mechanical level control, the frequency range in the footer changes to the corresponding scale-setting for the adjusting screw.

- "SMZxxx" without level control



Depending on the model of the frequency multiplier the R&S SMF adjusts the RF frequency and level automatically to the frequency multiplier, and shows the values in the header. Accordingly, further adjustments can be made in this block. For information in detail, see the manual of your R&S SMZ75/90/110.

3.4 Example of Setup

This section provides an example on how to configure the instrument for generating of an amplitude modulated signal and of a frequency modulated signal with noise.

Generation of an Amplitude-Modulated Signal

To generate a simple AM-modulated signal, proceed as follow:

1. Activate default (preset) state
Press the PRESET key to set a defined instrument state.

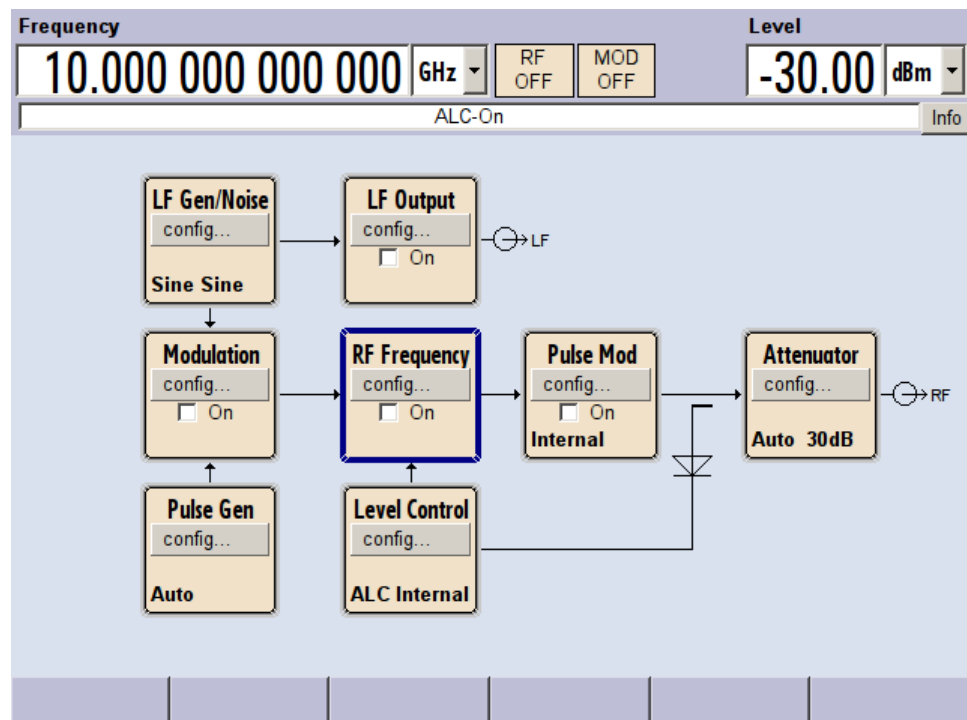

2. Select and activate AM modulation
 - a) Turn the rotary knob and select the "Modulation" block.

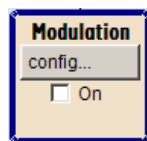

- b) Press the rotary knob to open the dialog where the modulation can be selected (different modulation modes are available depending on the options installed).

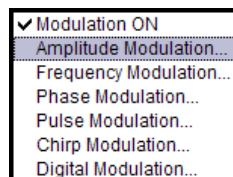

- c) Turn the rotary knob and highlight "Amplitude Modulation".
Press the rotary knob to open the "Amplitude Modulation" dialog.

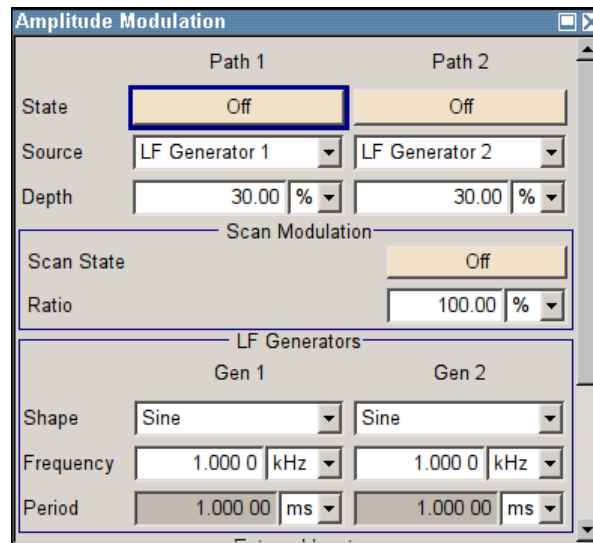

- d) Turn the rotary knob to select parameter "Depth", press the rotary knob to allow editing and enter the preferred AM depth with the aid of the numeric keypad and the unit keys.

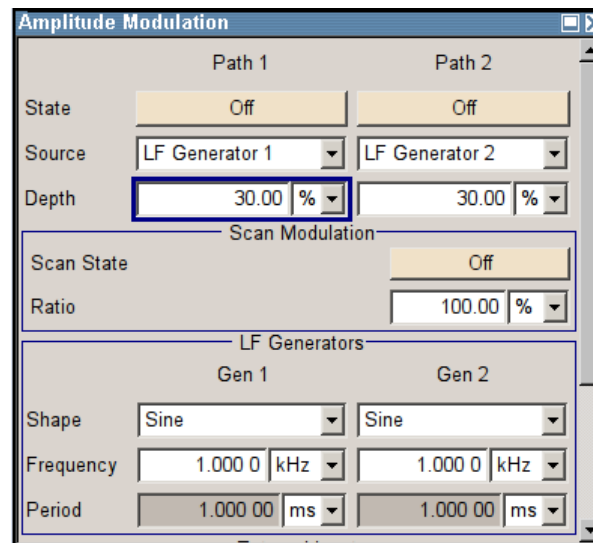

- e) Finally, select "State" and press the rotary knob to switch on the AM modulation.

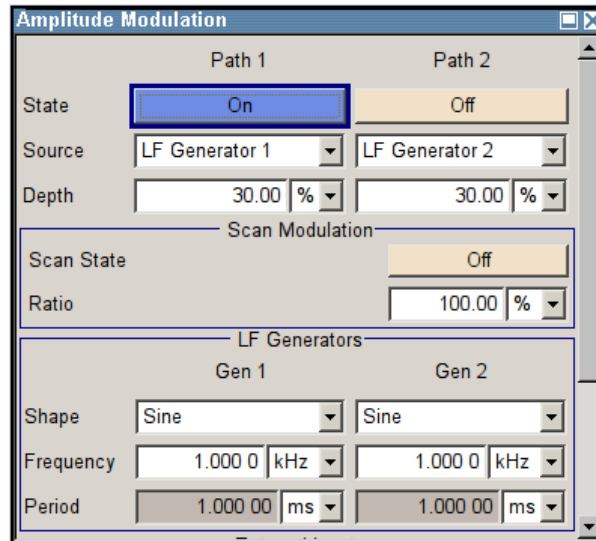

- f) Press the DIAGRAM key to display the complete block diagram.

To indicate the active state, the "Modulation" block is displayed in blue. The "RF Frequency" is not yet active, which means that no RF signal is output.

3. Set frequency and level and activate RF signal

- a) Press the FREQ key to activate the editing mode for frequency entry. The "Frequency" entry field in the header section of the display is highlighted.

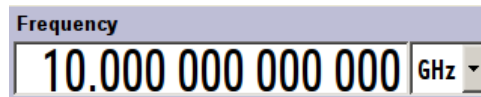

Enter the frequency of the desired RF carrier using the numeric keypad and terminate the entry by pressing a unit key.

- b) Press the LEVEL key and enter the level settings in the same way.

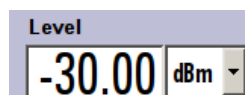

- c) Press the DIAGRAM key to display the complete block diagram.
 d) Turn the rotary knob to select the "RF Frequency" block.
 Press the RF ON/OFF key to activate the "RF Frequency" block.

The AM modulation signal is now present at the RF output.

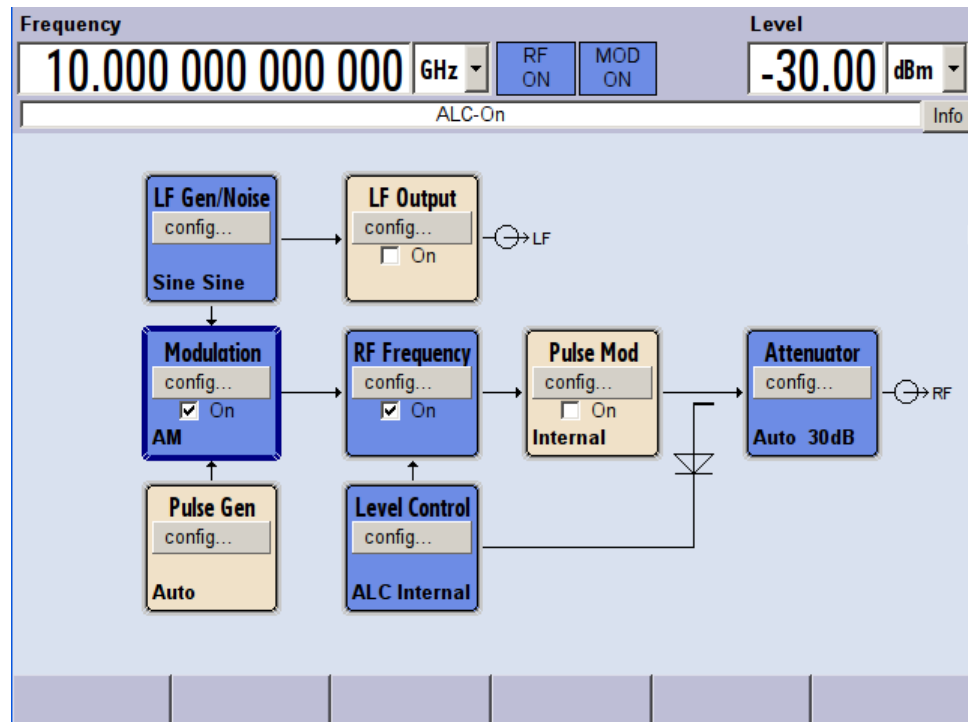

Generation of a Frequency Modulated Signal with Noise

To generate a simple FM-modulated with noise signal, proceed as follow:

1. Activate default (preset) state
Press the PRESET key to set a defined instrument state.

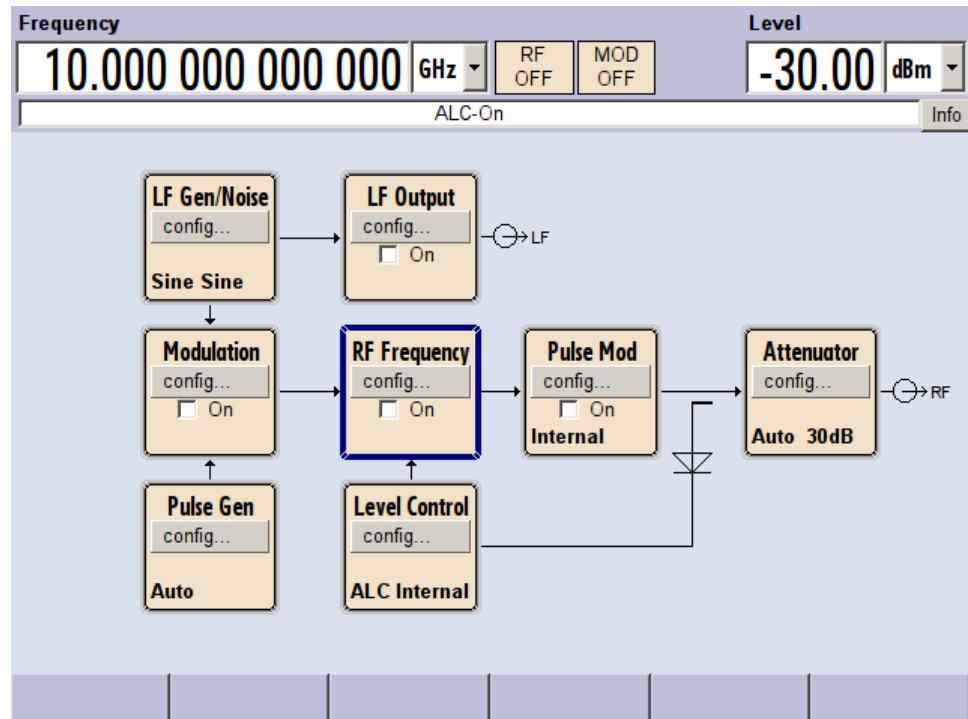

2. Select and activate FM modulation with internal noise signal and a deviation of 500 kHz

a) Turn the rotary knob and select the "Modulation" block.

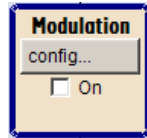

b) Press the rotary knob to open the dialog where the modulation can be selected (different modulation modes are available depending on the options installed).

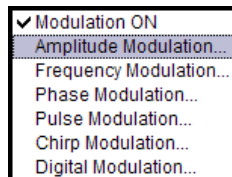

c) Turn the rotary knob and highlight "Frequency Modulation". Press the rotary knob to open the "Frequency Modulation" dialog.

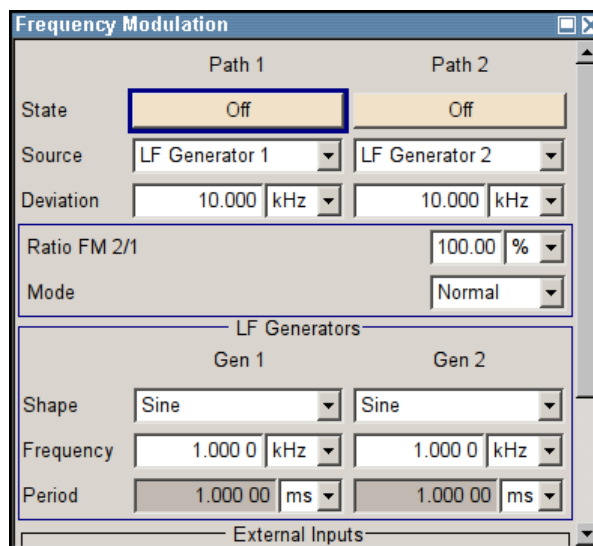

The internal source is the LF generator 1 by default. This setting is not changed.

- d) Turn the rotary knob to select parameter "Source", press the rotary knob to open the selection list and select "Noise Generator".

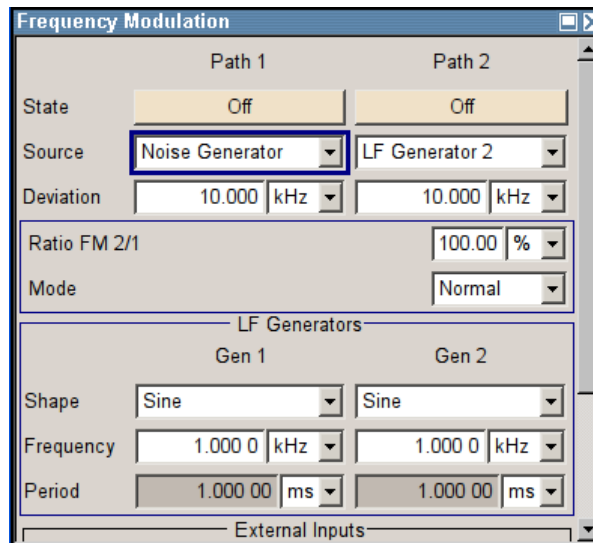

The settings for the noise generator are performed in the "LF Gen./Noise" block. Gauss distribution and full bandwidth (10 MHz) are the default settings for the noise signal.

- e) Turn the rotary knob to select parameter "Deviation", press the rotary knob to allow editing and enter the preferred deviation with the aid of the numeric keypad and the unit keys.

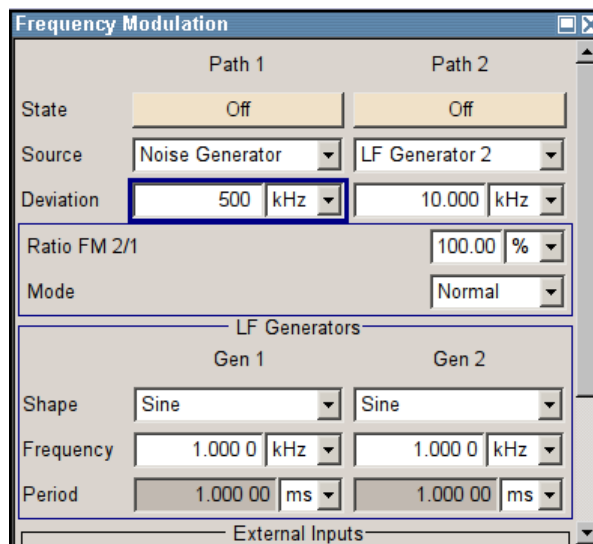

- f) Finally, select "State" and press the rotary knob to switch on the FM modulation.

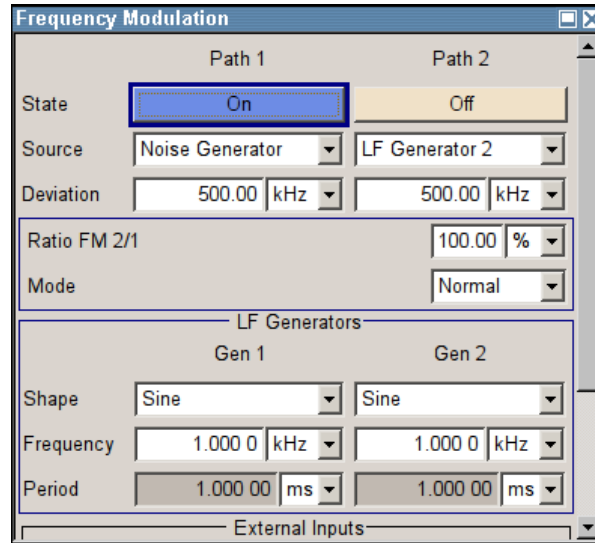

- g) Press the DIAGRAM key to display the complete block diagram.

To indicate the active state, the "Modulation" block is displayed in blue. The "RF Frequency" is not yet active, which means that no RF signal is output.

3. Set frequency and level and activate RF signal

- a) Press the FREQ key to activate the editing mode for frequency entry. The "Frequency" entry field in the header section of the display is highlighted.

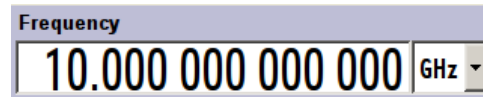

Enter the frequency of the desired RF carrier using the numeric keypad and terminate the entry by pressing a unit key.

- b) Press the LEVEL key and enter the level settings in the same way.

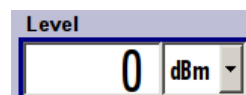

The noise now modulates the RF carrier.

- c) Press the DIAGRAM key to display the complete block diagram.
 d) Turn the rotary knob to select the "RF Frequency" block.
 Press the RF ON/OFF key to activate the "RF Frequency" block.

The FM modulation signal is now present at the RF output. The LF output is not yet activated, i.e., the modulation signal is not output there.

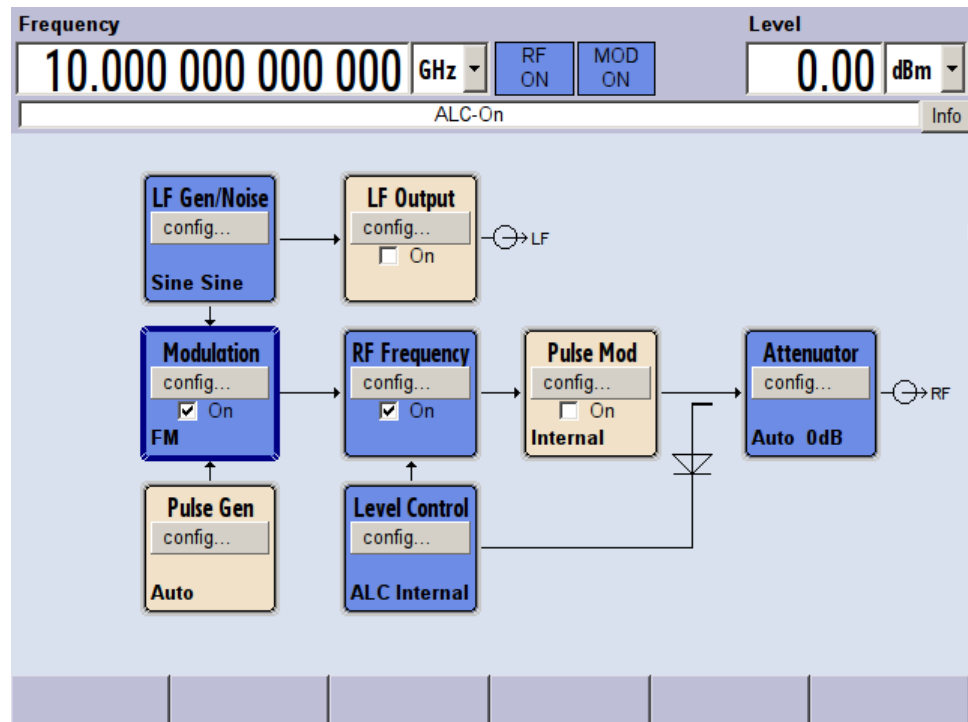

The graph below shows the FM modulated signal with noise (upper blue trace) and the unmodulated signal (lower greentrace).

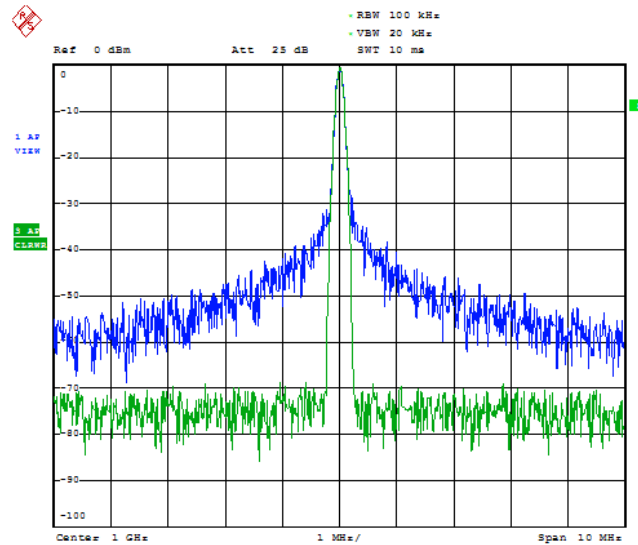

Date: 13. DEC. 2005 15:15:42

4 Manual Operation

The R&S SMF can be operated intuitively either via the interactive block diagram or via a menu tree. All menus are in the form of windows that can be operated in the same way. Rotary knob, keys and softkeys, or alternatively a mouse, allow direct and therefore convenient access to entries and settings.

The clear-cut display shows the current signal generator state. Numerous help functions support the user in signal configuration.

This section describes the concept of manual operation of the signal generator. This includes a description of the general structure of a dialog box, working with dialog boxes and the block diagram and the setting of parameters.

For an in-depth description of the dialog boxes and the instrument functions refer to section "Instrument Functions".

4.1 Key Features

The manual operating concept of the R&S SMF enables the user to make settings as intuitively as possible and at the same time gives a permanent overview of characteristics of the generated signal and of the current instrument state. Numerous online help functions support user settings.

Block diagram

The block diagram is the core of the operating concept.

A graphics display shows the current configuration and the signal flow in the form of a block diagram. All graphical elements can be accessed for operation. An element is selected by means of the arrow keys and the associated setting function is called by pressing Enter. Required menus and graphs are displayed on the block diagram which is displayed again in the foreground whenever the DIAGRAM (CTRL+D) key is pressed.

Permanent frequency and level display

The main characteristics of the RF signal, frequency and level, are permanently displayed in the header section of the screen and can be directly set in the display fields after the FREQ (CTRL+F) or LEVEL (CTRL+L) key is pressed. Status messages for the output signal are displayed in addition to frequency and level.

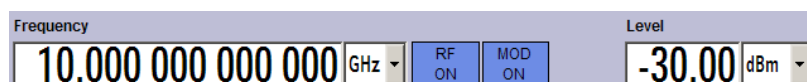

Operation via Graphical User Interface

- **Functional blocks**

Menus are assigned to the specific function blocks in the block diagram. The function blocks represent elements of signal generation. Function blocks displayed with a blue frame can be directly switched on and off by means of the TOGGLE ON/OFF (CTRL

+T) key. The menus of the highlighted function blocks can be called by pressing the ENTER key.

– **Example:**

The "Modulation" block contains all menus required for modulation signal configuration.

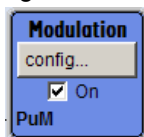

In this block all modulations can be selected.

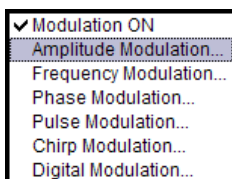

• **Signal flow**

The signal flow between the function blocks and the employed inputs and outputs are also shown.

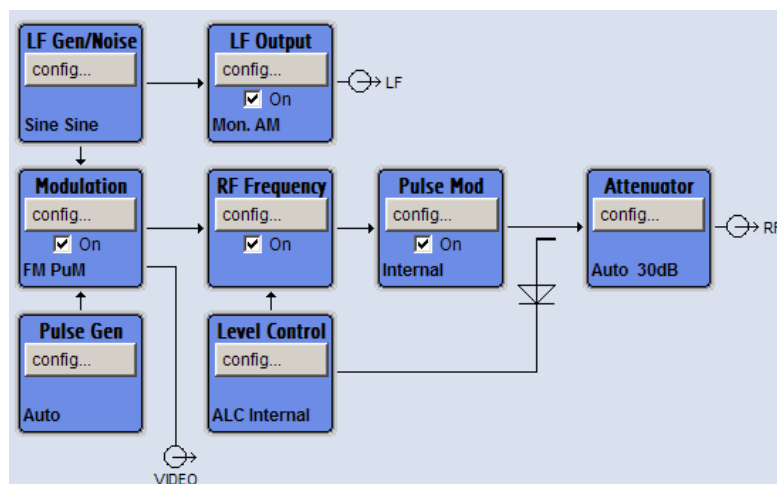

• **Menu tree**

The menu tree can be opened and closed with the MENU (CTRL+M) key. The menu tree is organized in the same way as the directories under Windows. The function blocks correspond to the first directory level, the menus to subdirectories.

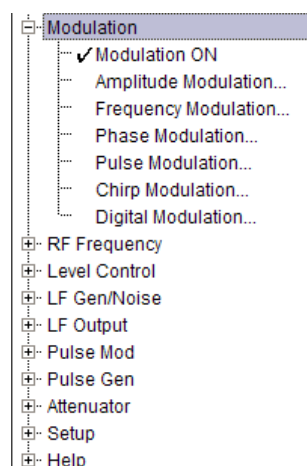

Operation corresponds to the Windows concept

To offer the user a familiar environment, operation is very similar to operation of Windows user interfaces. All menus and tables are made up of known elements, such as selection lists, check boxes and entry fields.

A blue frame indicates that the selected item is active. In the highlighted element, entries can be made.

Rotary knob



Operation is possible via front-panel keys, an external keyboard and the mouse. However, most of the settings can be easily made with the rotary knob:

- Turning the rotary knob shifts the entry focus to the target element.
- Pressing the rotary knob activates the selected entry field. Depending on the parameter, the submenu is called, the numeric value varied, the list entry selected or the check box activated or deactivated.
- If a value is entered, the entry is stored by another click on the rotary knob and the editing mode is exited.

Clear settings with the aid of independent subdialogs

A separate window is opened for each dialog and subdialog. The dialogs can be operated independently of each other, i.e. none of the dialogs requires that settings in other dialogs be completed before it can be closed. This ensures flexible operation at all times.

Winbar

The Winbar gives an overview of menus and simplifies their access.

The menus are displayed on top of the block diagram but they can be "hidden" using the DIAGRAM key. They can be displayed again in full size (WINBAR key). This makes room on the screen for other displays that may be required but the setting menus can thus be accessed any time.

LF Gen Noise	RF Freq Phase	Pulse Mod / Gen			
-----------------	------------------	--------------------	--	--	--

Keys with assigned simple functions

Most keys on the front panel of the R&S SMF directly perform a simple function.

Since a great number of settings can thus be made by a keystroke, operation is easy. For instance, the CLOSE (ESC) key closes the active menu; with the RF ON/OFF (CTRL+R) key the RF output signal can be switched on or off.

An exception are keys that call a menu such as the MENU (CTRL+M) key which opens the complete menu tree of the instrument, the SETUP (CTRL+E) key which opens the menus for general instrument settings or the FILE (CTRL+S) key which opens the menu for file management.

Help functions for user support

Numerous help functions support the user in signal configuration.

- **Value ranges**

The valid setting range is displayed for each numeric parameter. This requires a short wait after activation of the entry field. The range is then displayed automatically after a few seconds.

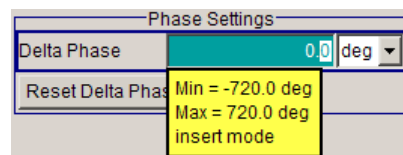

If the entered value is outside the permissible range, the next permissible value is automatically set and a message is output.

- **Context-sensitive help**

Context-sensitive help for each parameter can be called with the HELP or F1 key.

- **Comprehensive online help**

Each help page is part of a comprehensive online help function which can be called by means of an index, a content tree or the "Previous/Next" buttons.

Info line with messages for indication of the current instrument state

A great variety of different messages such as status messages, error messages, warnings or information are displayed in the header field of the screen. With the aid of the INFO (CTRL+I) key, help pages can be called for most of the messages. They provide background information on the message and indicate operating steps that may be required. All messages are explained in the online help which can be called with the HELP (F1) key.



4.2 Display

The display shows the current signal generator state and offers graphical elements for direct operation. It is divided into three sections:

- The frequency and level display with info line indicates the main output signal parameters and reports the current state with status, error and warning messages.
- The block diagram shows the instrument configuration, the signal characteristic as well as the inputs and outputs used and permits interactive operation via graphics elements. Active menus and graphs are displayed on top of the block diagram.
- Winbar with labelled softkeys for menu display.

The block diagram in the figure below shows a fully equipped instrument.

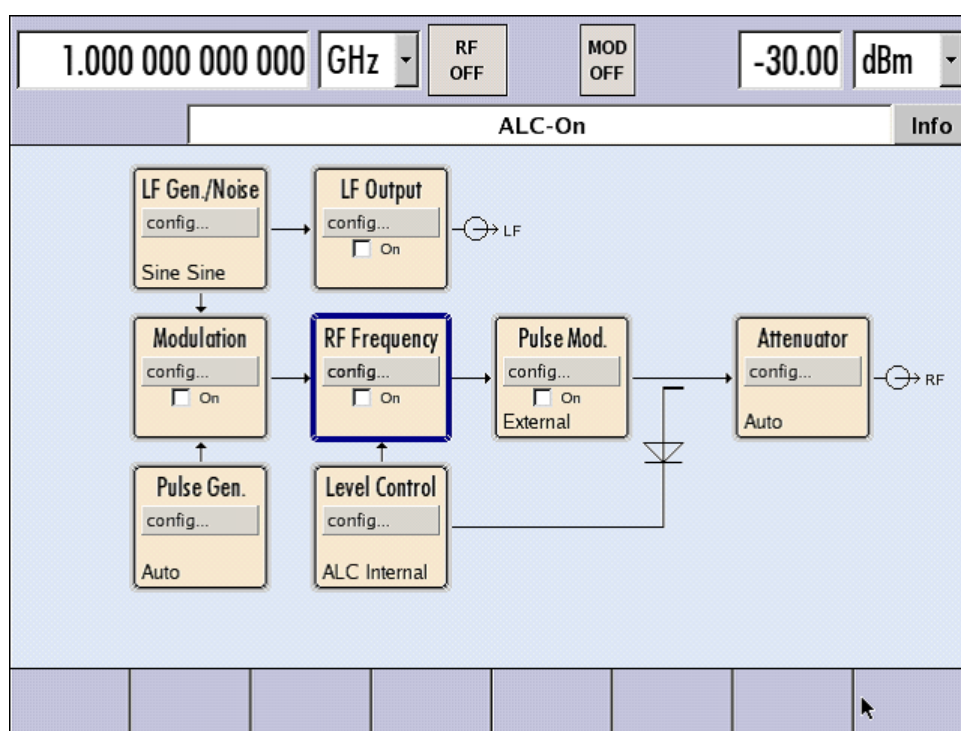

Fig. 4-1: Block diagram of a fully equipped R&S Microwave Signal Generator

4.2.1 Settings Displayed in the Header Section

Frequency/level settings and a few status messages (see [chapter 4.2.2, "Status Information and Messages"](#), on page 64) are displayed in the header field of the screen. The display may vary depending on the instrument's operating mode:

- In the sweep mode, the current frequency or level of the output signal is displayed. The status message "SweepMode" is displayed in the info line.
- In the list mode, neither the current frequency nor level is displayed, the indication is dimmed.
- If user correction is active, the status message "UCorr" is displayed in the info line.



The value displayed in the "Freq" and "Level" field does not consider any offset set or multiplier factor.

For more information see [chapter 5.3.2, "RF Frequency Settings"](#), on page 124 and [chapter 5.4.1, "Overview of RF Level"](#), on page 149.

4.2.2 Status Information and Messages

The status information and messages are displayed in the header section of the screen. The messages differ with respect to their importance (errors, warnings, info) and the time of their appearance (brief and permanent messages). They require different treatment by the user. Further information on all messages can be called in the info window (see [chapter 4.2.3, "Info Window"](#), on page 65).

Refer to [chapter 9, "Error Messages"](#), on page 527 for an overview of all status information and messages as well as instructions for error elimination.

4.2.2.1 Status Information

The status information gives the user an overview of the main operating states and settings of the instrument. The states are indicated for information only and do not necessitate any action by the user.

Status information is displayed between the frequency and level fields, at the left of the info line or in the info line itself.

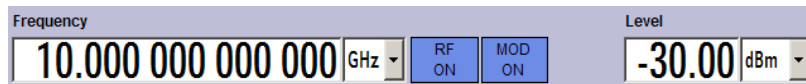

4.2.2.2 Messages

Messages indicate errors in the instrument. They are displayed in the info line in different colors depending on their importance and display duration. Errors (e.g. no calibration data) are displayed in red, information (e.g. file not found) and warnings in black. Warnings indicate less significant errors (e.g. the instrument operates outside specified data).

4.2.2.3 Volatile messages

Brief messages report automatic settings in the instrument (e.g. switching off of incompatible types of modulation) or on illegal entries that are not accepted by the instrument (e.g. range violations). They are displayed in the info line on a yellow background. They are displayed on top of status information or permanent messages.

Volatile messages do not normally demand user actions and disappear automatically after a brief period of time. They are stored in the history, however.

These messages can be read from remote using `SYST:ERR?` or `SYST:ERR:ALL?`.

4.2.2.4 Permanent Messages

Permanent messages are displayed if an error occurs that impairs further instrument operation, e.g. a hardware fault. The error signalled by a permanent message must be eliminated before correct instrument operation can be ensured.

The message is displayed until the error is eliminated. It covers the status display in the info line. After error elimination, the message automatically disappears and is also recorded in the history.

These messages can be read from remote using `SYST:SERR?`.

4.2.3 Info Window

A few operating states and the current message are displayed in the info line.

The INFO window with a list of current permanent messages and a detailed description of each message can be opened with the INFO (CTRL+I) key.

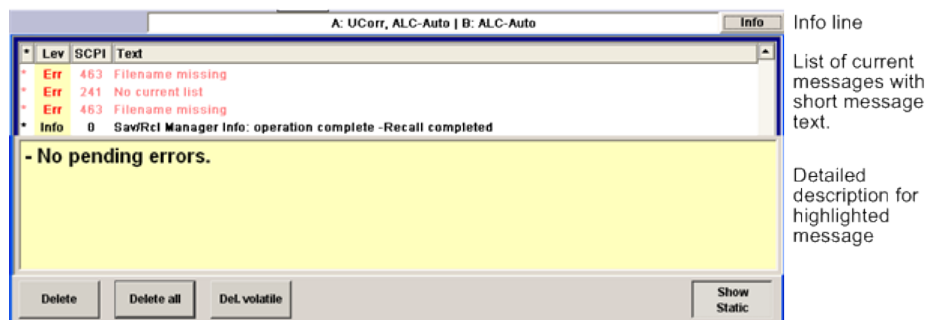

The upper section of the info window contains a list of all current permanent messages in the order of their occurrence, i.e. the most recent message is displayed first. In the lower section of the window, additional information on the highlighted message is displayed. A history of all messages that have occurred since instrument switch-on can be called with the "History" key. The most recent message is displayed first.

The messages are color-coded according to their level. Device-specific messages are red, info and remote control error are black. The level is also indicated in the "Lev" column (Err, Sys or Info). Column "SCPI" indicates the SCPI error code.

With the aid of the softkey buttons, error messages can be cleared and a history of all messages called.

Delete

Clears the highlighted message.

This button is available only if the history of the messages is displayed.

Delete All

Clears all messages.

This button is available only if the history of the messages is displayed.

Del. volatile

Clears all volatile messages.

This button is available only if the history of the messages is displayed.

SCPI command:

`SYSTem:ERRor:ALL` on page 510

Each time a `SYST:ERR:ALL?` query is sent, the error queue is returned and at the same time cleared.

History

Calls the list of all messages that have occurred since instrument switch-on. The most recent messages are displayed at the top of the list. When the button is pressed again, the list of current messages is displayed.

SCPI command:

`SYSTem:ERRor[:NEXT]` on page 512 or `STATus:QUEue[:NEXT]` on page 503

Each time a `SYST:ERR?` or `STAT:QUE?` query is sent, the oldest entry in the error queue is returned and at the same time cleared in the list.

4.2.4 Block Diagram

The block diagram shows provided options, signal configuration and the currently selected signal flow of the generator with inputs and outputs used. Signal generation can be completely operated from the block diagram. The highlighted function block can be directly switched on and off with the TOGGLE ON/OFF (CTRL+T) key. Pressing the Enter opens the associated setting menu.

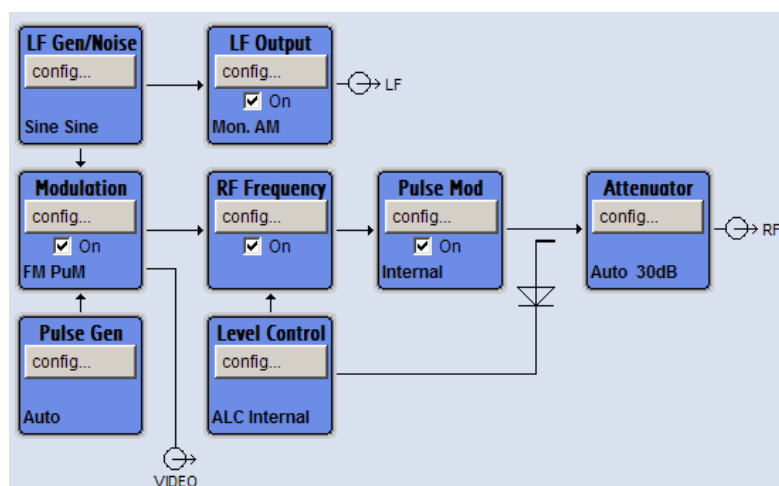

Fig. 4-2: Block diagram of the R&S SMF

4.2.4.1 Function Blocks in the Block Diagram

Each block represents a function of signal generation. The function is indicated in the headline of the block. In the check box, the respective function can be quickly activated/deactivated with the TOGGLE ON/OFF (CTRL+T) key. After activation, the block is dis-

played in blue. Status information is displayed below the check box. It is different for the different blocks.

Pressing the rotary knob (front panel) or the "Config..." button (mouse) opens the associated setting menu.

Example: Modulation block

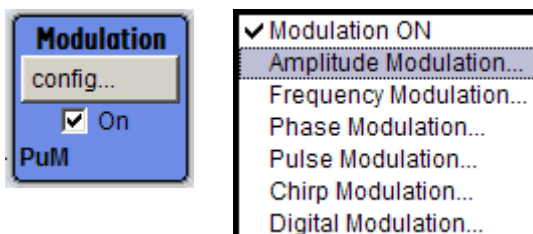

In this block, the modulation signals are set. The status information of the "Modulation" block indicates the selected modulation.

4.2.4.2 Signal Flow and Input/Output Symbols in the Block Diagram

The input/output symbols in the block diagram show the currently used inputs and outputs of the signal generator. Unused inputs and outputs are not shown. The lines indicate the signal flow.

Symbols and labels refer to the corresponding inputs and outputs on the front and rear panel of the signal generator. The direction - input or output - is indicated by an arrow.

Example:

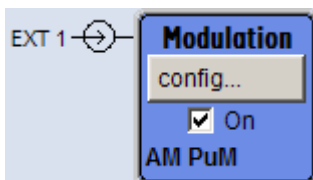

The symbols indicate the input for the external pulse signal on the instrument rear panel.

4.2.5 Structure of the Dialogs

The parameters are set in the menus. Menus are accessed either via the function blocks in the diagram or by means of the MENU (CTRL+M) key. The menus are displayed on top of the block diagram.

Working with menus and dialog boxes is described in [chapter 4.3, "Accessing Dialogs"](#), on page 68; the setting of parameters in [chapter 4.4, "Setting Parameters"](#), on page 69.

The menus are in Windows format. The menus differ in details depending on their function but they consist of the same main elements. Each menu consists of a menu header and one or more menu areas with various fields for setting parameters.

The header line contains the name of the menu and the buttons for minimizing and closing the menu. To operate the buttons, use the mouse or the front key CLOSE (ESC).

Several fields of associated but separately set parameters are organized in menu areas. A menu area is framed and labelled with the function common to all parameters.

Example: Pulse Generator

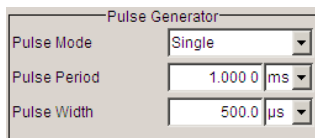

Each of the setting fields is assigned a parameter name. The kind of setting varies depending on the parameter to be set. Some settings can only be made in a specific configuration. If setting is not permitted with the specific configuration selected, the respective item is disabled and displayed in gray and the entry or selection field cannot be accessed.

4.3 Accessing Dialogs

The MENU (CTRL+M) key opens the complete menu tree. Selecting a functional block and pressing the ENTER key opens the menu associated with this block.

An alternatively way to access a dialog is to use the Winbar buttons or front-panel softkeys or to use the HIDE (CTRL+H), CLOSE (ESC), DIAGRAM (CTRL+D) and REARR (CTRL+A) keys on the front panel.

For a quick access to the dialogs, use one of the following alternative methods.

Displaying the block diagram or a dialog in the foreground

1. Press the DIAGRAM (CTRL+D) key to move the cursor to the block diagram.
All active menus are minimized and displayed in the form of Winbar buttons.
2. Press the associated softkey (CTRL+F1 .. F8) to display the dialog in the foreground again.

Accessing the menu tree

- ▶ Press the MENU (CTRL+M) key to open the complete menu tree.

Calling the File, Setup or Hardcopy dialogs

- ▶ Use the FILE (CTRL+S), SETUP (CTRL+E) or HCOPIE (CTRL+Y) keys to open the respective dialog.

Minimizing an active menu

- ▶ Use the HIDE (CTRL+H) key to minimize an active menu.
It is displayed in the form of a Winbar button.

Automatically arranging displayed menus

- ▶ Press the REARR (CTRL+A) key to rearrange all open menus so that they overlap as little as possible.

Activating the Windbar

- ▶ Use the WINBAR (CTRL+W) key to toggle the cursor between a button of the "Winbar" and the block diagram.

The button that was active last in the Winbar is highlighted.

Closing an active menu

- ▶ Press the CLOSE key to close an active menu.

Tip: If the cursor is at the highest menu level, you can also use the ESC key to close the active menu.

Accessing the header area

- ▶ Press the FREQ (CTRL+F) and LEVEL (CTRL+L) keys to activate the "Frequency" or "Level" entry fields in the header area.



Keyboard Shortcuts

Keyboard shortcuts (e.g. "Ctrl + D" for the displaying the block diagram in the foreground) provide direct access to all utility dialogs of the instrument (see [chapter 4.8, "Legend of Front-Panel Controls"](#), on page 83).

4.4 Setting Parameters

The R&S SMF offers several and sometimes alternative possibilities for setting parameters. Operation is possible from the front panel, with the aid of a mouse and/or from a PC keyboard.



The examples within this description focus on the operation from the front panel.



For more information, refer to:

- [chapter 4.8, "Legend of Front-Panel Controls"](#), on page 83 for an overview of key functions and a cross-reference between the front panel keys and the keyboard shortcuts
 - section "Instrument Functions" for a detailed description of key functions.
-

Most of the parameters are set in the different menus. The R&S SMF provides alternative ways for accessing the dialogs. Turn the rotary knob and navigate to the corresponding

block in the block diagram and press the knob to open the dialog or perform a mouse click on the "Config..." button.

An exception are the "Setup", "File" and "Hcopy" dialogs. In the "Setup" dialog, general settings are made which are not directly concerned with signal generation, e.g. setting of the GPIB-bus address. In the "File" dialog, files and lists are managed; in the "Hcopy" dialog, printout is configured and hardcopies can be made. These menus can only be called with the SETUP (CTRL+E), FILE (CTRL+S) and HCOPY (CTRL+Y) keys.

Frequency and level are directly set in the header area of the display using the FREQ and LEVEL keys.

Specific settings can also be made directly in the block diagram, e.g. activating a function block by means of the TOGGLE ON/OFF (CTRL+T) key or switching the RF output on and off with the aid of the RF ON/OFF (CTRL+R) key. Changes affecting the signal flow are immediately visible in the graphics display.

This section provides an information about the parameter handling that comprises of the following main steps:

- [chapter 4.4.1, "Working with the Cursor"](#), on page 70
- [chapter 4.4.2, "Selecting a Control Element"](#), on page 71
- [chapter 4.4.3, "Switching Parameters On/Off"](#), on page 71
- [chapter 4.4.4, "Entering a Value"](#), on page 71
- [chapter 4.4.5, "Working with Units "](#), on page 73
- [chapter 4.4.6, "Selecting a Value from a List"](#), on page 74
- [chapter 4.4.7, "Terminating Entries with Confirmation"](#), on page 74
- [chapter 4.4.8, "Restoring the Previous Value"](#), on page 75

4.4.1 Working with the Cursor

After the instrument is switched on, the cursor is always on the first function block of the diagram (default setting).

Moving the cursor on the display

► To move the cursor, use one of the following alternative methods:

- a) Use the rotary knob or the arrow keys.
- b) Use the appropriate softkeys (CTRL+F1..F8) to move the cursor to the "Winbar".
If the "Winbar" is covered by a menu, press the WINBAR (CTRL+W) key to display it in the foreground.
- c) Use the ESC key.

Tip: Be aware that the function of the ESC key depends on the current cursor position. The function of this key depends on the current cursor position.

- Calls the next higher selection level.
- Closes the open window without accepting new entries; the old value or parameter is retained.
- In dialog boxes that contain a "Cancel" button it activates that button.

- Closes all kinds of dialog boxes, if the edit mode is not active.
- Quits the edit mode, if the edit mode is active.
- Switches between different entry fields of a menu.
- Shifts the entry cursor from the header display to the previously active menu, or to the previously highlighted block in the block diagram if no menu is active.

Moving the cursor to the heading area

- ▶ Press the **FREQ** (CTRL+F) or **LEVEL** (CTRL+L) key to move the cursor to the header area.

4.4.2 Selecting a Control Element

Control elements are always selected in the same way no matter whether a function block in the diagram, a menu in the menu tree, a parameter in the menu or an entry in a list or table is concerned.

- ▶ To activate an element, put the cursor on it.



An active element is highlighted by a blue frame.

4.4.3 Switching Parameters On/Off

A parameter can be activated and deactivated using a button or a check box.

1. Select the parameter.
2. To change the state of a parameter, use the "Enter" function of the different control media:
 - Press the rotary knob
 - Press ENTER
 - Press the **TOGGLE ON OFF** (CTRL+T) key.

Colour and label of a button change, the check box is ticked or the tick is removed.

4.4.4 Entering a Value

Numeric and alphanumeric values can be edited in the entry fields. In the editing mode, cursors of different colour are used. A blue cursor indicates the overwrite mode, a green cursor the insert mode.

Numeric and alphanumeric values can either be newly entered or the existing value can be changed. Incorrect entries are cleared with the **BACKSPACE** key.

Entering a new numerical value

1. Select the parameter.

2. Press a numeric key to activate the editing mode.

The previous value is cleared and the new value can be entered.

Editing a value in the insert mode (default setting)

1. Press the rotary knob (= Enter) to activate the editing mode.

If the cursor is placed at the right of the total value, the insert mode is always active.

2. Set the cursor to the left of the number to be changed using the LEFT/RIGHT arrow keys.

The cursor is displayed in green.

3. Click on a numeric key to insert a new value.



Editing a value in the overwrite mode

1. Activate the editing mode.

2. Set the cursor on the numeric digit to be changed using the LEFT/RIGHT arrow keys.

The cursor is displayed in blue and the number to be replaced is highlighted.

3. Click on a numeric key to overwrite the highlighted value.



Varying a value

1. Activate the editing mode.

2. Set the cursor to the left of the number to be changed using the LEFT/RIGHT arrow keys.

The value at the cursor position is varied.

3. To vary the selected value, use the UP/DOWN arrow key or turn the rotary knob.

The value is increased or decreased.

Entering a new alphanumerical value

1. Select the parameter.

2. Press an alphanumeric key to start the editing mode.

The new value is entered.

Editing an alphanumerical value

An existing value, e.g. a file name, can be changed in the insert mode (see example) or in the overwrite mode.

1. Select the parameter and activate the editing mode.

- Set the cursor to the left of the alphanumerical value using the LEFT/RIGHT arrow keys.

Tip: If hexadecimal values are to be entered, the numeric front-panel keys are automatically changed to hexadecimal values.

- Click on an alphanumeric key to insert a new alphanumerical value.

Terminating the entry of a numeric value

To terminate the entry of a numeric value:

- Press the rotary knob (= Enter).
- Press a UNIT key on the front panel.
- Select a "Unit" in the selection field next to the parameter value.

4.4.5 Working with Units

The unit of a parameter is displayed next to the value. When the parameter is edited, the unit is selected either from the list or by means of the front-panel keys. When the entry is completed, the unit can be changed. In this case the value remains unchanged but is automatically adapted to the new unit.



While operating the instrument by means of a mouse, assign the unit to the selected parameter before entering its value.

Assigning a unit

To assign a unit to a value, use one of the following alternatives:

- Press a UNIT key on the front panel.



- Select a "Unit" in the selection field next to the parameter value.
Press the ENTER key.

The unit displayed in the entry field next to the value is assigned.

Changing a unit

To subsequently change a unit, i.e. after the entry has been terminated and when the editing mode is not active, use one of the following alternatives:

- Press a UNIT key on the front panel.
- Select "Unit" in the selection field next to the parameter value.

The value remains unchanged but the display is automatically adapted to the new unit, i.e. the value is recalculated to suit the new unit.



The new unit is indicated in the value field of the menu.

4.4.6 Selecting a Value from a List

Selection lists provide a list of predefined values for the selected parameter.

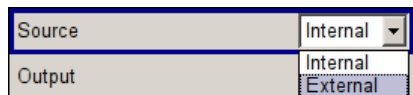

To select a item from a list, proceed as follow:

1. Press ENTER key to open the list.
2. Use one of the following alternatives to navigate through the list:
 - a) Turn the rotary knob or use the UP/DOWN arrow keys.
The selected item is highlighted.
 - b) Press TOGGLE ON/OFF key several times until the preferred entry is displayed in the selection field.
3. To confirm the selection, press the ENTER key.

4.4.7 Terminating Entries with Confirmation

The instrument behaves different by the termination of entries depending on the parameter type and the way this parameter is set.

Confirming settings

- ▶ To confirm the settings, press the rotary knob or one of the UNIT keys (see also [chapter 4.4.5, "Working with Units"](#), on page 73).

Note: Variations by means of the rotary knob are immediately set.

Confirming multiple values

In some cases, like for instance when editing data in a user correction table, it is useful first to enter few values and to confirm them together. Such settings require additional confirmation. Not yet confirmed settings are displayed on a yellow background as an indication that the currently displayed values do not represent the target signal.

- ▶ To confirm these settings, select the "Save" or "Accept" button, respectively.

Confirming parameters with On/Off state

Most of the instrument functions with enabled and disabled states are calculated and effective only after this functions have been enabled. However, there are functions like the frequency variation of the reference oscillator for instance, that are immediately set after confirmation.

- ▶ To confirm a parameter with On/Off state, enable the parameter.

4.4.8 Restoring the Previous Value

Parameter variations with the rotary knob are immediately set and therefore not reversible.

Normally, values cannot be restored in the case of mouse control because no explicit confirmation is required in this case and entries are automatically confirmed when the entry or selection field is exited.

Restoring values

In the case of front-panel control or operation from the keyboard, previous values can be restored as long as the new value is not confirmed, i.e. the entry is not completed.

- ▶ To restore the values, press the ESC key.

Restoring values that require confirmation

All settings that are not confirmed with the "Accept" button but require this additional confirmation can be restored.

1. Press the ESC key.

A confirmation query is displayed.

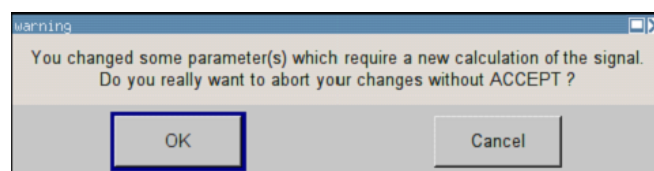

2. Confirm with "OK" to abort the changes.
Select "Cancel" to return to the dialog. The previous selected settings are displayed.

Restoring values after an extended calculation has been started

Calculation and setting might require different period of time. Many settings are made without noticeable calculation times; such operations are indicated by a "BUSY" message displayed in the status field of the header section.

A window with a progress indicates that the instrument performs an extended calculation that requires longer calculation time. The termination of such a calculation restores the previous values.

- ▶ Press the ABORT button to terminate the calculation.

All previous values are restored.

4.5 Editors

The R&S SMF provides user-friendly editors for defining lists. Lists containing frequency and level value pairs are used for the list mode and the user-defined level correction.

The lists are saved to files and may thus have any length. The file name of the lists and the directory to which the files are saved are user-selectable. The file prefix is different for each list type and is permanently assigned by the system.

For information about file handling and overview of the automatically assigned file prefixes, refer to [chapter 4.7, "File Management"](#), on page 79.

4.5.1 Working with List Editor

The "User Correction" and "List Mode" dialogs provide a list editor for defining the frequency/level value pairs.

Editing list mode data lists

1. To access a list editor and open an existing data list for editing, use the cursor keys to select the associated button "Edit User Correction Data..." or "Edit List Mode Data..." (if available) in the individual menu.

The selected list is displayed and the cursor marks the first row of the "Frequency/Hz" column.

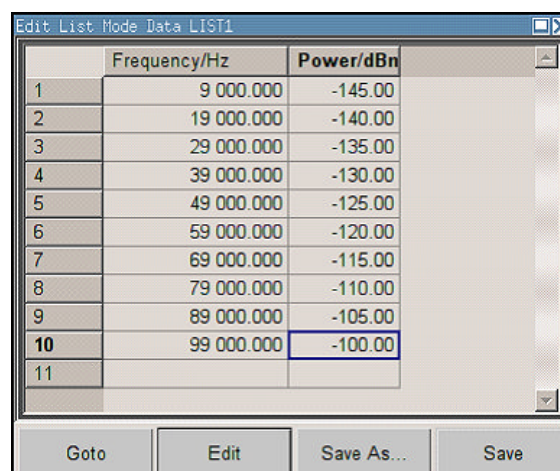

	Frequency/Hz	Power/dBn
1	9 000.000	-145.00
2	19 000.000	-140.00
3	29 000.000	-135.00
4	39 000.000	-130.00
5	49 000.000	-125.00
6	59 000.000	-120.00
7	69 000.000	-115.00
8	79 000.000	-110.00
9	89 000.000	-105.00
10	99 000.000	-100.00
11		

If no list has been selected, a blank list of only one row is displayed.

2. Press the LEFT/RIGHT arrow keys to change between the columns.
Use the UP/DOWN arrow keys to mark a row.
3. Use the numeric keys to enter the value for the value pairs in the "Frequency/Hz" and "Power/dBm" table columns. A blank row is inserted at the end of the list.
Terminate the entry by pressing a UNIT key.
4. To select a row, select the "GoTo" button and press the ENTER key.
Use the numeric keys to enter the row index in the entry field and press the ENTER key to confirm the entry.
The cursor moves to the selected row.
5. To insert a new row in the table, select the row above which the new row is to be inserted and select "Insert Row(s)".
A row is inserted above the currently marked row.
If no row has been selected, a row is inserted at the beginning of the list.
6. Use the "Save"/"Save As..." function to save the edited list under its current name or under a new name.
Enter the file name in the "File Select" dialog and select the directory (see [chapter 4.7.1, "File Select Dialog"](#), on page 80).
Only complete value pairs are taken into consideration; rows containing an entry in only one column are ignored.

Creating a new list mode data list

A new list can be created under a new name either by generating a blank file in the "File Select" menu (see section [chapter 4.7, "File Management"](#), on page 79) or by changing an existing list which will then be saved under a new name.

1. To create an empty data list, select "RF > List Mode > List Mode Data... > New List" or respectively "RF > User Correction > User Cor. Data... > New User Correction Data" and enter the file name of the new data list.
2. To open the data list for editing, select the associated button "Edit User Correction Data..." or "Edit List Mode Data..." in the individual menu.
Edit the list and save it under a new name.

4.6 How to Use the Help System

The R&S SMF is equipped with a context-sensitive help function. A help page is available for each parameter and can be called any time during instrument operation.



Compiled online help systems are also available for all functions of the R&S SMF on the CD-ROM supplied with the instrument. This help program can be called on any controller with Internet Explorer version V4.0 and higher.

Calling context-sensitive and general help

- ▶ To display the general help dialog box, press the HELP (F1) key.

The help dialog is displayed. A topic containing information about the current menu or the currently opened dialog box and its function is displayed.

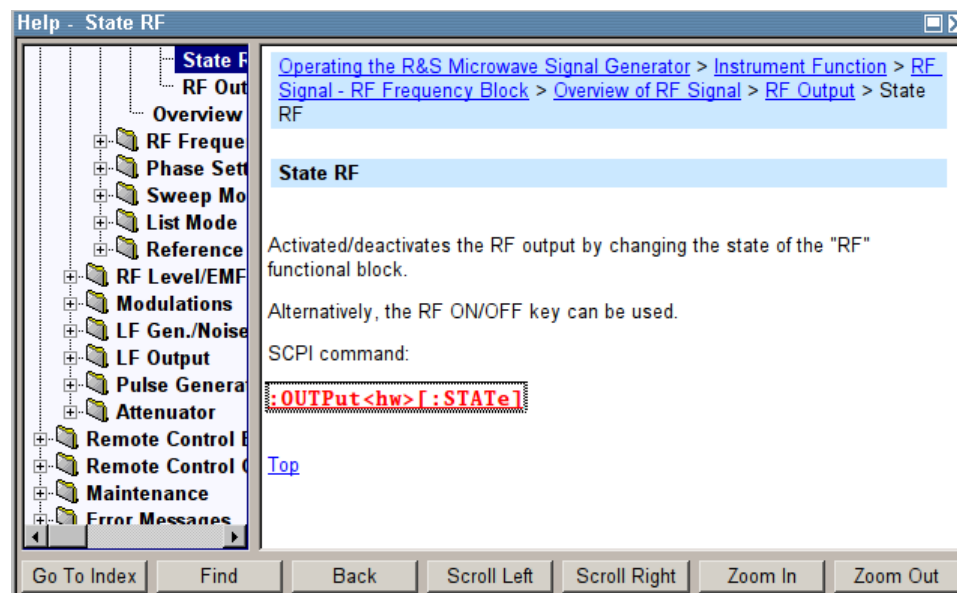

Contents of the help dialog box

The help dialog box contains two main areas:

- "Contents" - contains a table of help contents
- "Topic" - contains a specific help topic

The help system provides additionally an "Index" and a "Find" area, as well as "Zoom" functions that are accessed by means of the corresponding buttons.

Navigating in the table of contents

1. To move through the displayed contents entries, use the UP/DOWN keys. Entries that contain further entries are marked with a plus sign.
2. To display a help topic, press the "ENTER" key.
The corresponding help topic is displayed.

Navigating in the help topics

1. To scroll through a page, use the UP/DOWN arrow keys.
2. To jump to the linked topic, press the link text.
3. Use the "Previous" or "Next" links to jump to the corresponding topic.
4. Use the "Scroll Right" or "Scroll Left" buttons to shift the indicated area of the navigation window to the left or right.

Using the Index

1. Select the "Go to Index" button.
2. Enter the first characters of the topic you are interested in. The entries starting with these characters are displayed.
3. Press the ENTER key to change the focus.
4. Use the UP/DOWN keys to navigate and select the suitable keyword.
5. Press the ENTER key to display the help topic.
The corresponding help topic is displayed.

Closing the help window

- ▶ Press the HELP (F1) key.

4.7 File Management

The R&S SMF uses files to save all instrument data, i.e. system and user data.

The user data includes saved instrument settings and lists and the user correction.

The files are stored on the CompactFlash™ card of the instrument. The `/var` directory can be used to save user-defined data; any subdirectory structure can be created on `/var`. Some default subdirectories are predefined, but can be changed at any time.

The `/opt` directory is a protected system drive and therefore unaccessible system directory. The files on this directory contain data that must not be changed. Therefore, this drive should not be accessed, since reconstruction of the system partition will lead to data loss. To prevent inadvertent deletion or overwriting of system files, this drive is not specified in the file menus.

Files can be exchanged either via a memory stick or a connected network. A memory stick is connected to the USB interface and is assigned the `/usb` drive. In the case of a connected network, all network drives that can be accessed are available. The files are accessed in a "Save/Recall" dialog in the individual menus.

The files are differentiated according to their extensions; each type of file is assigned a specific file content. The extension is usually of no consequence to the user since access to the files occurs in the individual menu where only the relevant type of file is available. See [chapter 4.7.2.1, "Extensions for User Files"](#), on page 82 for an overview of the supported file extensions.

The user data can be roughly divided into the following data types:

- Settings
Instrument settings can be saved and loaded. In case of saving, the current setting is saved to the specified file.
- Lists

Lists, e.g. user correction lists, can be loaded. They can be generated either externally or internally. For internal generation, a new list must be created in the "File Select" dialog which will then be edited in the list editor of the individual menu.



For more information, refer to:

- [chapter 4.8, "Legend of Front-Panel Controls"](#), on page 83 for an overview of key functions and a cross-reference between the front panel keys and the keyboard shortcuts
- to section "Instrument Functions" for a detailed description of key functions.

Accessing files with user data

1. To access an editable user data file, select the "Save/Recall" or "File Manger" function in the individual dialog.

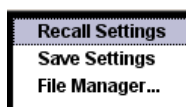

2. To access a loadable data file, select the "Select/New" or "File Manager" function in the individual dialog.

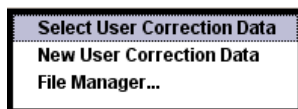

3. To access the "File Manager" function, press the SETUP (CTRL+E) key and select "Save/Recall > File Manager".

A "File Select" window for loading, saving or creating a file or the "File Manager" dialog for managing all files is displayed.



Saving and loading of all instrument settings

All instrument settings are saved and loaded in the "File" menu.

To access the "File" menu, press the FILE (CTRL+S) key.

For more information, see [chapter 5.2.8, "Storing and Loading Instrument Data - File Key"](#), on page 117.

4.7.1 File Select Dialog

The "Save/Recall" dialog displays the available drives and directories. In the upper part, "Recent Data Sets", the files last used are listed.

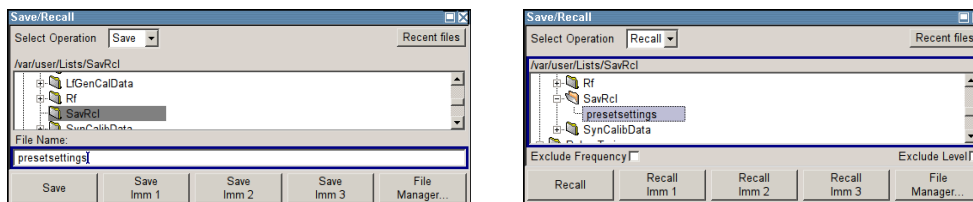

The available drives and directories and the files of the selected directory are displayed. The currently selected path is displayed above the window. Only the relevant files without file extensions are displayed. If the area is opened several times, the path last selected is displayed. When a file is saved or created, its name is user-selectable; the extension is assigned automatically and cannot be entered. The file is saved to the selected path.

In addition to the files saved by the user, some menus also offer files containing predefined contents. These files are saved to a specific directory on system drive; for this reason, this directory cannot be chosen from the "File Select" menu.

Working with the File Select dialog

1. Access the "File Select" dialog (see ["Accessing files with user data"](#) on page 80).
2. Navigate in the "File Select" dialog.
3. Load an existing file.
In the "Recall Settings" dialog, mark a file and press the "Select" button.
4. Save a file.
In the "Save Settings" dialog, enter file name in the "File Name:" field.
Select the directory to which the file is to be saved and then select the "Save" button.
5. Create a new file.
To create a new file, use the "Save Settings" functionality, i.e. specify file name and directory and save the file.

The created file is empty; it must be filled with the necessary values in the individual editor.

4.7.2 File Manager

The "File Manager" allows general file management such as copying, shifting, renaming and deleting files as well as generating new directories.

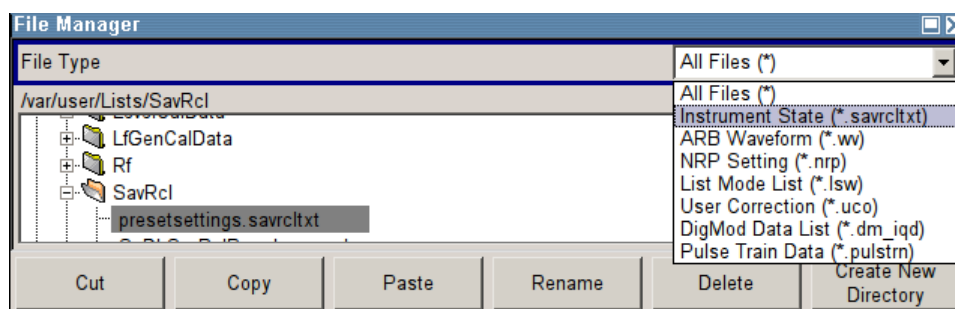

Use the "File Type" to select a file type from the list. This can be used to process either all files (all files (*) selection) or a specific selection of files. See [chapter 4.7.2.1, "Extensions for User Files"](#), on page 82 for an overview of the supported file extensions. The available drives and directories and the files of the selected directory are displayed. The currently selected path is displayed above the windows. If the area is opened several times, the path last selected is displayed. Unlike the "File Select" window, the "File Manager" displays the full file names including extensions.

Working with the File Manager dialog

1. Accessing the "File Manager" dialog (see ["Accessing files with user data"](#) on page 80).
2. Navigating in the "File Manager" dialog.
Operation is similar to the operation of menus with several areas.
3. Moving, duplicating, deleting or renaming files
To move a file, select the file and press the "Cut" button. Mark the directory to which the file is to be moved and select the "Paste" button. If the target directory already contains a file with the same name, a confirmation query is displayed to confirm overwriting of this file.
Perform the similar steps and cut/copy/rename/delete the file.
Tip: The operation corresponds to the Windows concept.
4. Creating a new directory
Mark drive or directory level where the new directory is to be created, select the "Create New Directory" button and enter the name of the new directory in the entry window that opens. Confirm with ENTER.

4.7.2.1 Extensions for User Files

The following table list all available file extensions for user files. The currently available files on the instrument depends on the installed options.

Table 4-1: List of the automatically assigned file extensions in the instrument

Function	List type	Contents	File suffix
Instrument State	Settings	Instrument settings	*.savrc1txt
"User Correction"	List	User-defined level correction values	*.uco
		Export Data	*.txt or *.csv
"List Mode"	List	User-defined frequency/level value pairs	*.lsw
		Export Data	*.txt or *.csv
"Pulse Train List"		User-defined offtime/ontime/repetition values	*.pulstrn
ARB Waveform		ARB Waveform	*.wv

Function	List type	Contents	File suffix
SMZ Settings	Settings	Data (firmware) of a connected SMZ frequency multiplier	*.efmfirm
NRP Settings	Settings	NRP Settings	*.nrp

4.8 Legend of Front-Panel Controls

The following table lists all key functions available on the front panel. Key combinations used on the PC keyboard to trigger key functions on the instrument front panel are also described. Keyboard labels are described in alphabetical order.

In addition, a front panel key emulation and an on-screen keyboard can be used for manual operation by mouse only.

Table 4-2: Cross-reference between the front panel keys and keyboard shortcuts

Front-panel key	Key of PC keyboard	Function
Turning the rotary knob	Tab key (towards the right) Shift + Tab (towards the left)	Sets the cursor with the rotary knob.
Pressing the rotary knob	Enter	Pressing the rotary knob confirms an entry; it has the same function as the ENTER key.
Arrow keys	Arrow keys	Moves the cursor.
*1 / dB(m)	ALT + F12	Confirms entries in the base unit and values without a unit. Selects dBm for the RF level and dB for level offset and level step width.
. / *...#	. / *...#	Enters a period/decimal point. Enters a special character.
+/- / A<->a	- / (shift+) a—z	Enters the sign. Switches between upper-case and lower-case letters.
0-9 / a...z	CTRL+ 0-9 / a...z CTRL	Enters the number/letter.
BACKSPACE	Backspace	Clears the last entry (number, sign or decimal point)
CLOSE	CTRL + G	Closes an active menu.
DIAGRAM	CTRL+ D	Sets the cursor on the block diagram and hides all menus.
ENTER	Enter	Terminates an entry.
ESC	ESC	Selects the next higher menu/selection level. When the editing mode is exited with ESC, the previous value is restored.
FILE	CTRL + S	Activates the menu for storing instrument settings.
FREQ	CTRL+ F	Activates the frequency entry.

Front-panel key	Key of PC keyboard	Function
G/n / dBuV	ALT + F9	Selects the unit Giga/Nano, dBuV for the RF level and dBu for the LF level.
HCOPY	CTRL+ Y	Opens the menu for configuring and starting a hard-copy.
HELP	F1	Opens/closes context-sensitive help.
HIDE	CTRL+ H	Minimizes the active menu. Pressing the respective button in the Winbar opens the menu again.
INFO	CTRL + I	Opens/closes the info window
INSERT	Ins	Activates the insert mode.
k/m / mV	ALT + F11	Selects the units kilo/milli and mV for RF levels.
LEVEL	CTRL + L	Activates the level entry.
LOCAL	CTRL + Q	Switches the instrument from remote control to manual control.
M/u / uV	ALT + F10	Selects the units Mega/Micro and uV for RF levels.
MENU	CTRL + M	Calls the menu selection list.
MOD ON/OFF	CTRL + O	Switches modulation on/off. "MOD OFF" is indicated in the status line.
ON/OFF TOGGLE	CTRL + T	Switches a block or parameter on/off. Toggles between the different possibilities of setting a selection parameter.
PRESET	CTRL + P	Restores a defined basic instrument setup.
REARR	CTRL + A	Adjusts the size of the active menu to use the whole height of the display.
RF ON/OFF	CTRL + R	Switches the RF output signal on/off. "RF OFF" is indicated in the status line.
SETUP	CTRL + E	Opens the setup menu for general instrument settings.
Softkeys	CTRL + F1 – F8	Triggers the function assigned to the softkey.
STATUS	CTRL +	Indicates the instrument status.
WINBAR	CTRL + W	Displays the Winbar in the foreground/background.

4.8.1 Front Panel Key Emulation

The R&S SMF provides a front panel key emulation to enable execution of the front panel key functions by mouse e.g. for remote access. The emulation is called by a right mouse click. The front panel key functions are executed by a mouse click on the associated button.

Freq	Diagram
Level	Menu
File	Rearr.
RF On/Off	WinBar
Mod On/Off	Help
Preset	
Local	
Setup	
Hardcopy	
Info	

5 Instrument Function

5.1 Overview of Instrument Functions

This chapter explains the functions of the R&S SMF and the options available in the setting menus. The associated SCPI command is specified for each parameter (where applicable).

The description starts with the general instrument settings which do not directly affect signal generation. The majority of these settings can be accessed by means of front-panel softkey menus and not by means of function block menus.

The signal generation functions are then described, beginning with the functions which affect the RF signal ("RF Frequency" block), the level control ("Level Control" block), and the analog and digital modulations ("Modulation" block). The next section describes the LF signal generation ("LF Gen./Noise" block) and the LF output ("LF Output" block). This is followed by an description about the configuration of the internal pulse generator ("Pulse Gen." block) and the modulation of the internal or external pulse signal ("Pulse Mod." block). The remaining part of this chapter describes the attenuator settings ("Attenuator" block).

The general instrument settings include various functions, such as:

- Setting a defined basic setup using the PRESET key
see [chapter 5.2.2, "Default Instrument Settings - Preset Key"](#), on page 89
- Switching from remote control to manual control using the LOCAL key
see [chapter 5.2.4, "Switching to Manual Control - Local Key"](#), on page 112
- Configuring the generator and its interfaces in the "Setup" dialog - e.g. setting the GPIB address, starting an adjustment, querying instrument data
see [chapter 5.2.3, "General Configuration of Instrument - Setup Key"](#), on page 90
- Generating a hardcopy of the display using the HCOPI key
see [chapter 5.2.5, "Generating a Hard Copy of the Display"](#), on page 112
- Calling up the online help using the HELP key
see [chapter 5.2.7, "Help System - Help Key"](#), on page 116
- Querying messages using the INFO key
see [chapter 5.2.6, "Messages - Info Key"](#), on page 115
- Loading and storing complete instrument settings in the "File" menu
see [chapter 5.2.8, "Storing and Loading Instrument Data - File Key"](#), on page 117

The RF signal and the reference oscillator are configured in the "RF Frequency" function block:

- CW mode
see [chapter 5.3.1, "Overview of RF Signal"](#), on page 122
- List mode
see [chapter 5.3.5, "List Mode"](#), on page 137
- Frequency and Level Sweep mode
see [chapter 5.3.4.1, "Overview"](#), on page 127

- Reference Oscillator
see [chapter 5.3.6, "Reference Oscillator"](#), on page 146

The RF level control is configured in the "Level Control" function block:

- RF Level
see [chapter 5.4.1, "Overview of RF Level"](#), on page 149
- RF Level Sweep
see [chapter 5.4.4, "RF Level Sweep"](#), on page 153
- ALC
see [chapter 5.4.5, "Automatic Level Control - ALC"](#), on page 160
- Power Sensors
see [chapter 5.4.6, "Power Sensors"](#), on page 163
- User Correction
see [chapter 5.4.7, "User Correction"](#), on page 208

The analog and external digital modulations are activated in the "Modulation" function block:

- Amplitude Modulation
see [chapter 5.5.2, "Amplitude Modulation \(AM\)"](#), on page 218
- Frequency Modulation
see [chapter 5.5.3, "Frequency Modulation \(FM\)"](#), on page 221
- Phase Modulation
see [chapter 5.5.4, "Phase Modulation \(PhiM\)"](#), on page 223
- Digital Modulation
see [chapter 5.5.5, "Digital Modulation"](#), on page 226
- Pulse Modulation
see [chapter 5.5.6, "Pulse Modulation \(PM\)"](#), on page 229

The internal LF generators, the LF frequency sweep, and the noise generator are configured in the "LF Gen./Noise" function block:

- LF Gen./Noise
see [chapter 5.6, "LF Gen./Noise"](#), on page 235
- LF Frequency Sweep
see [chapter 5.6.3, "LF Frequency Sweep"](#), on page 239
- The LF output is configured in the "LF Output" block, see [chapter 5.7, "LF Output"](#), on page 247.
- The pulse generation is configured in the "Pulse Gen." block, see [chapter 5.8, "Pulse Generator"](#), on page 255
- The attenuator is configured in the "Attenuator" block, see [chapter 5.9, "Attenuator"](#), on page 263

5.2 General Instrument Settings

5.2.1 Overview of General Instrument Settings

This section describes the settings which do not directly affect signal generation. Most of these settings can only be accessed by means of menus which are opened using keys or key combinations on the external keyboard or keys on the front panel key emulation.

The general instrument settings therefore affect various functions, such as storing instrument settings using the FILE key or setting the GPIB address in the menu of the SETUP key. The order in which the descriptions are given corresponds to the layout of the keys on the front panel of the R&S SMF (from top left to bottom right).

5.2.2 Default Instrument Settings - Preset Key

The PRESET key calls up a defined instrument setup. All parameters and switching states are preset (also those of inactive operating modes). The default instrument settings provide a reproducible initial basis for all other settings.

However, functions that concern the integration of the instrument into a measurement setup are not changed, e.g. GPIB address or reference oscillator source settings.

When the instrument is switched on, it is not the preset state that is active, but rather the instrument state that was set before the instrument was switched on.

User-defined instrument states can be stored and called up in the "File" menu.



Resetting the instrument to the factory state is possible with the [Factory Preset](#) function.

Preset

Presets all parameters and switching states.

The following list gives an overview of the presets for the most important generator settings. The other presets can be found in the preset tables of the individual menus and the information accompanying the remote commands.

- "RF frequency" = 1 GHz
- "RF level" RF output switched off
- "Offsets" = 0
- "Modulations State" = Off
- Uninterrupted level settings are switched off
"Level Attenuator Mode" = AUTO
- Internal level control "Level ALC" = AUTO
- User correction "Level Ucor" = OFF
- "LF output State" = Off
- "Sweep State" = Off
- "List mode State" = Off

Settings that are not affected by the PRESET key

- Reference frequency settings ("Ref Oscillator" menu)
- Power on settings ("Level/EMF" menu)
- Network settings ("Setup" menu)
- GPIB address ("Setup" menu)
- *IDN? Identification and emulation ("Setup" menu)
- Password and settings protected by passwords ("Setup" menu)
- Start/Stop Gui Update ("Setup" menu)
- Display and keyboard settings ("Setup" menu)

SCPI command:

*RST on page 308

5.2.3 General Configuration of Instrument - Setup Key

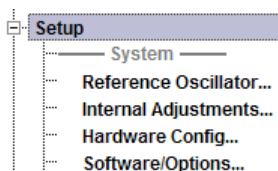

The SETUP key opens the "Setup" dialog.

The "Setup" dialog is divided into several sections.

- The "System" section is used to set general instrument parameters.
- The "Test" section is used to perform function tests.
- The "Environment" section is used to configure the controller interfaces.
- The "Remote" section is used to configure the remote control interfaces.
- The "Protection" is used to set the protection level for service functions and security settings.
- The "Settings" section is used to save or recall instrument settings or to preset the instrument to factory settings.

Most submenus of this key can be accessed only via the SETUP key or the menu tree (MENU key), with the following exceptions:

- The "Reference Oscillator" dialog can also be called up in the "RF" block and is therefore described in the section on this block (see [chapter 5.3.6, "Reference Oscillator"](#), on page 146).
- The "Save/Recall" dialog can also be called up with the FILE key and is therefore described in the section on this key (see [chapter 5.2.8, "Storing and Loading Instrument Data - File Key"](#), on page 117).

5.2.3.1 Internal Adjustments

The R&S Microwave Signal Generator is extremely accurate thanks to the integrated procedures for adjustments.

All internal adjustments for which no external measuring equipment is needed can be started in the "Internal Adjustments..." dialog. The adjustments with external measuring equipment are described in the Service Manual (on CD ROM, supplied with the instrument).

Adjustment is recommended if the temperature range in which the instrument is operated changes, or prior to all applications which require maximum level and frequency accuracy.

During adjustment a bar indicates the status of progress. If an error occurs, adjustment is terminated and an error message is output in the info line.

NOTICE

Risk of invalid adjustment

In order to achieve correct adjustment of the instrument, make sure that the instrument is warm before performing adjustments. The warm-up time is 30 minutes.

NOTICE

Risk of damage to the DUT

High power at the RF output may destroy a connected DUT (**D**evice **U**nder **T**est). During level adjustment, instruments without step attenuator (R&S SMF-B26 or R&S SMF-B27) temporarily provide high power at the RF output. This may damage the DUT. Therefore it is required that the RF connector is terminated during adjustment. Disconnect the DUT and replace it by a 50 Ohm terminating resistor.

To access the "Internal Adjustments" dialog, press the SETUP or MENU key under "System".

The adjustments offered also depend on the installed options.

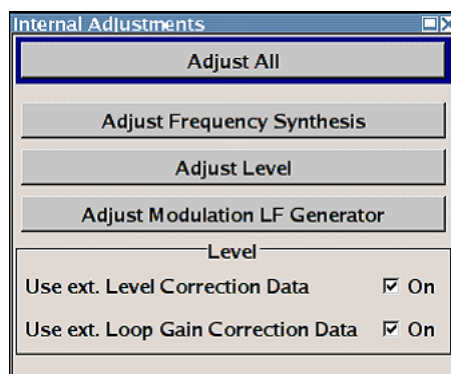

Adjust All

Starts all internal adjustments for which no external measuring equipment is needed. The adjustments with external measuring equipment are described in the Service Manual (supplied).

SCPI command:

`:CALibration:ALL[:MEASure]` on page 311

Adjust Synthesis

Performs all adjustments which affect the frequency.

This includes adjustment of option R&S SMF-B20, AM/FM/SCAN modulator, LF and Low Phase Noise.

SCPI command:

`:CALibration<hw>:FREQuency[:MEASure]` on page 312

Adjust Level

Performs all adjustments which affect the level. The acquired correction values improve the settling time and the signal quality.

SCPI command:

`:CALibration<hw>:LEVel[:MEASure]` on page 312

Adjust Modulation LF Generator

Performs all adjustments that affect the internal modulation generators.

SCPI command:

`:CALibration:LFOutput[:MEASure]` on page 313

Use ext. Level Correction Data

Switch on or off use of external level correction data. This switch can be used in case of corrupt external level correction data.

By default the instrument uses correction data obtained in the factory before delivery. In addition, customer data can be used for external level correction. The customer data is obtained using a R&S NRP power sensor. External level correction is a protected function (see service manual, chapter 2, "Adjustment").

SCPI command:

`:CALibration<hw>:LEVel:STATe` on page 313

Use ext. Loop Gain Correction Data

Switch on or off use of external loop gain correction data.

This feature is a protected function (see service manual, chapter "Adjustment").

SCPI command:

`:CALibration<hw>:LEVel:LOOPgain:STATe` on page 312

Continue Adjustment On Error

Continues the internal adjustment automatically after an error was detected. By default, internal adjustment stops on error (see service manual, chapter "Adjustment").

This function is a protected function and can be accessed if protection level 1 is disabled.

SCPI command:

n.a.

5.2.3.2 Hardware Config

In the "Hardware Config" dialog, the installed assemblies together with their variants and revision states can be displayed for servicing purposes.

To open the "Hardware Config" dialog, select "System" and press the SETUP or MENU key.

Hardware Config				
Counter				
Operation Time / h				70
Power On Count				69
Common Assembly				
Assembly	Part Number	Serial Number	Revision	Slot
SMF100A	1167.0000k02	100113		
RF Assembly				
Assembly	Part Number	Serial Number	Revision	Slot
SIO-FPGA			01.03.00	
MWif	1167.1135.02	100087	02.04	Serial Bus Slot 5
OCXO	1167.9188.02	100029	01.00	Serial Bus Slot 15
TMO	1167.1993.02	100016	02.00	Serial Bus Slot 1
DMA	1167.2502.02	100021	06.00	Serial Bus Slot 8
Detector	1167.1441.02	100027	08.00	Serial Bus Slot 14
Filter	1167.5221.02	100012	03.00	Serial Bus Slot 10
HPA	1167.4009.02	100032	03.00	Serial Bus Slot 9
Attenuator 22	1400.2703.00	000000	01.00	Serial Bus Slot 5
Baseband Assembly				
Assembly	Part Number	Serial Number	Revision	Slot
IFBoard	1167.1206.02	100100	03.07	Serial Bus Slot 0

Section "Counter" in the upper part of the menu shows the "Operation Time" (in hours) and the number of power-on ("Power On Counter").

The second part of the menu is a table that lists the installed assemblies. It is divided into the sections:

- "Common Assembly"
- "RF Assembly"
- "Baseband Assembly"

Operation Time / h

Displays the operation time in hours.

SCPI command:

`:DIAGnostic:INFO:OTIME` on page 314

Power On Count

Displays the number of power-on.

SCPI command:

`:DIAGnostic:INFO:POCount` on page 314

Assembly

The tables list the installed assemblies.

"Assembly"	Assembly name
"Part Number"	Part Number of assembly
"Serial Number"	Serial Number of assembly
"Revision"	Revision state of assembly
"Slot"	Indicates whether the assembly is connected to the serial bus or PCI bus.

SCPI command:

`:DIAGnostic<hw>:BGInfo` on page 313

5.2.3.3 Software / Options

The "Software/Options" dialog shows the firmware version of the instrument software as well as all installed hardware and software options.



Software options purchased at a later stage can be activated with a keycode. The activation code is supplied with the software option. How to install options is described in Chapter 4 of the Service Manual (supplied with the instrument).

The installation of hardware options purchased at a later stage is also described in Chapter 4 of the Service Manual (supplied with the instrument). Most hardware options need to be installed at an authorized Rohde&Schwarz service shop.

To access the "Software/Options" dialog, select "System" and press the SETUP or MENU key.

The menu is divided into the following sections:

- "Firmware"
- "Hardware Options"
- "Software Options"

Firmware		
Package	Version	
SMF100A FW	02.05.47.10 (Release) (2008-02-07; 13:50:49)	
R&S COMPASS	2.2.2.3 (Release)	
Bios Version	LPC6--Bios-V0.30-GP-03.00	

Hardware Options		
Option	Designation	
SMF-B1	Reference Oscillator	
SMF-B20	AM/FM/SCAN Modulator	
SMF-B26	Attenuator up to 22 GHz	
SMF-B31	High Output Power 1 GHz to 22 GHz	
SMF-B83	Removable GPIB	
SMF-B84	Removable USB	
SMF-B122	1 GHz to 22 GHz	

Software Options (Internal)		
Option	Designation	Expiration Date
SMF-K0	Demo Option	2009-01-29; 15:00

Firmware

The Firmware section of the menu shows the firmware version and the version of the software platform.

Note: Your instrument is delivered with the latest firmware version available. Firmware updates as well as the Release Notes describing the improvements and modifications are provided on the Internet at the download site of the Rohde & Schwarz Signal generator home page. This home page always offers the latest information on your signal generator, e.g. also on changes of the firmware update procedure.

SCPI command:

n.a.

Hardware Options / Software Options

The tables in the sections "Hardware" and "Software" list the installed hardware and software options.

"Option" Short name of option

"Designation" Name of Option

"Expiration Date" For regular options, "Permanent" is indicated in this column. Some options are available as trial versions. This column shows their expiration date. After this date, the option is no longer available on the instrument.

SCPI command:

*[OPT](#) on page 307

*[IDN](#) on page 306

Loaded Modules

Section "Loaded Modules" is provided for service purposes. It lists all loaded software modules with their versions and offers a short description of each module.

SCPI command:

n.a.

5.2.3.4 Manage License Keys

This dialog is the central dialog for managing licenses, like enabling newly purchased and/or newly registered options or performing the required instrument related steps during the process of unregistration of licenses.

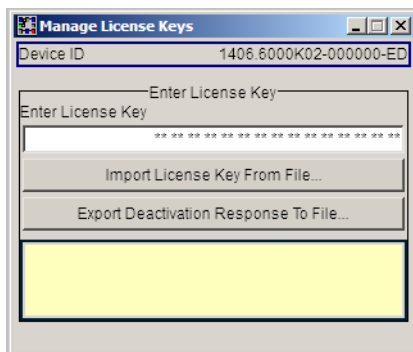

An option is ready to operate after it is enabled by means of a license key code supplied with the option. The license key is delivered as a file or on paper. Unregistered licenses must be registered for a particular instrument prior to the corresponding option can be enabled for operation.



License Registration

If your purchased license is delivered unregistered, you must register it before you can activate the option.

For detailed information about the license registration, refer to the installation instructions provided with the option (Supplement A) and the documentation of the online tool "Manage Licenses" (<https://extranet.rohde-schwarz.com/service>).



Only if the R&S Microwave Signal Generator is equipped with an older firmware version, a firmware update prior to enabling the software option may be required. The information on the valid firmware versions for the purchased software option is provided together with the option.

The firmware update is described in the service manual, chapter 4 (on CD ROM, supplied with the instrument).

Device ID

Displays the instrument specific identification number. The device ID is an unique string with the following structure:

```
<stock number>-<serial number>-<checksum>
```

Enter License Key

Type here the license key provided with the option.

For license keys delivered as a file, use [Import License Key from File...](#)

Import License Key from File...

Opens a dialog for selecting the file with the license key.

Export Deactivation Response to File...

Exports the generated deactivation response key to a file and opens a file management dialog to save the file. This key is required during the unregistration process.

Status Information

Displays status information.

5.2.3.5 Gui Update

The "Start/Stop Gui Update" dialog provides the possibility to switch off update of the displayed parameters in order to increase speed for certain settings.

The indicated values are not updated and may therefore differ from the intern, used values.

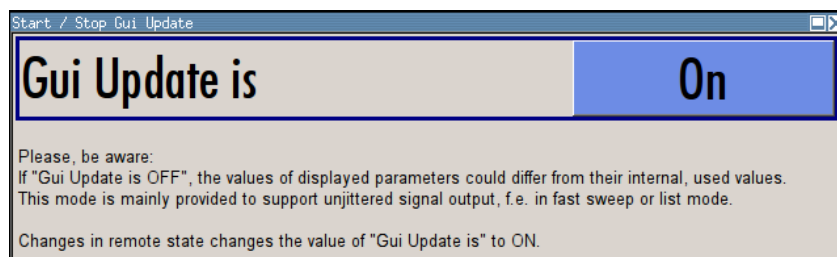

On/Off GUI Update

Switches on/off update of the displayed parameters.

Switching off the update of the displayed parameters increases the speed for certain settings.

Note: It is especially recommended to switch off the GUI update for optimum sweep performance with short dwell times and for fast settling times.

SCPI command:

:SYSTEM:DISPlay:UPDate on page 510

5.2.3.6 NRP-Z Info/Update

In the "NRP-Z Info/Update..." dialog, the connected power sensors are indicated together with their serial number, revision state and features in terms of support of the R&S SMF-K28 Power Analysis option. The software of a connected sensor can be updated to a new version.

To access the "NRP-Z Info/Update..." dialog, select "System" and press the SETUP or MENU key.

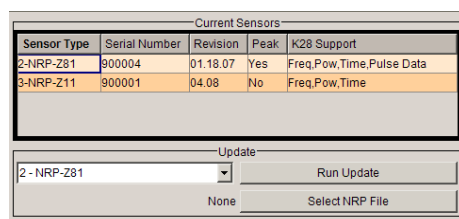

Current Sensors

Section "Current Sensors" lists the sensors that are connected to the generator and indicates their serial number, the revision state and some features.

Tip: Click on a sensor to get quick information about the firmware version and whether this sensor measures the peak of the signal.

"K28Support" indicates the R&S SMF-K28 measurement functions provided by the sensor.

SCPI command:

SENSe<ch>[:POWER]:TYPE on page 381

SENSe<ch>[:POWER]:SVERsion on page 350

SENSe<ch>[:POWER]:SNUMber on page 349

Update

Section "Update" provides access to the file system in order to select a file for an R&S NRP sensor update (Button "Select NRP File"), the selected file is indicated to the left of the button. On the left side, the sensor to be updated is selected.

Button "Run Update" starts the update. If the update is interrupted for example by accidentally pulling off the sensor, selection "Rescue" is offered to restart the update process. Prerequisite is that no other sensor is connected to the instrument.

The procedure is as follows:

- Do not reconnect the sensor but keep it ready to be connected
- Select "Rescue" in the left sensor selection field
- Activate "Run Update"
- Confirm query in message box
- Connect sensor within 4 seconds

The update starts, a bar informs about the progress.

SCPI command:
n.a.

5.2.3.7 Update

After a firmware update it is occasionally required to also update the "PCI-FPGA". This is enabled in the "Update" dialog.

At the first start of the new firmware, a message appears during the boot process if a "PCI-FPGA" update is required. Execute a PCI-FPGA update by pressing the "PCI-FPGA" button.

NOTICE

Impairment of instrument functions

To avoid impairment of instrument functions, the update of the "PCI-FPGA" must not be cancelled and the instrument must not be switched off during this update.

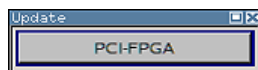

5.2.3.8 Check Front Panel

The "Check Front Panel" dialog is used to check whether the front panel keys are functioning correctly. The menu displays all the front panel keys arranged in the same way as on the front panel. The respective function is executed by pressing the associated key.

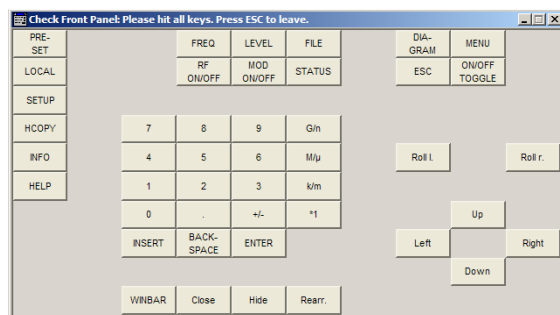

5.2.3.9 Date and Time

The "Date/Time..." dialog provides access to the system time and date settings. It is opened using the SETUP or MENU key under "Environment". The time is used on the internal controller.

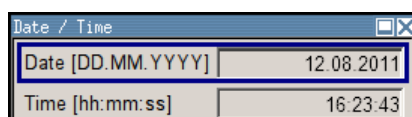



To prevent accidental changes, "Date" and "Time" are protected functions. They can be accessed with protection level 1, see [chapter 5.2.3.14, "Protection"](#), on page 106.

Date

Indicates the date in the format day.month.year.

In order to prevent accidental changes, this parameter is protected. It can be accessed with protection level 1, [chapter 5.2.3.14, "Protection"](#), on page 106.

SCPI command:

:SYSTem:DATE on page 509

Time

Indicates the time in the format hour.minute.second

In order to prevent accidental changes, this parameter is protected. It can be accessed with protection level 1, see [chapter 5.2.3.14, "Protection"](#), on page 106.

SCPI command:

:SYSTem:TIME on page 515

5.2.3.10 Network Settings

The "Network Settings" dialog provides access to the network settings. To access this dialog, press the SETUP or MENU key under "Environment". The R&S SMF is equipped with a network interface and can be connected to an Ethernet LAN (local area network).

How to connect the signal generator to the network is described in [chapter 2.6.1, "Connecting the Instrument to the Network"](#), on page 35.

NOTICE

Risk of network errors!

Connecting errors may affect the entire network.

We recommend to coordinate the connection of the instrument to the network with the network administrator.

Do not connect or disconnect the network cable until the instrument is **switched off** (standby). Only then the network connection can be reliably detected and impairments to instrument operation can be avoided.

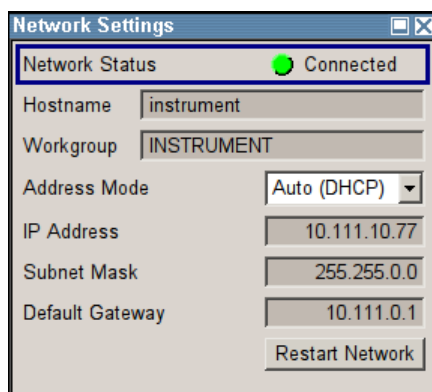

The dialog provides an access to the network settings, like settings about the general network environment and specific identification of the computer in the network, as well as an indication whether the instrument is connected to the network or not.

Network Status

Indicates whether the instrument is connected to the network or not.

SCPI command:

n.a.

Hostname

Enters the individual computer name of the R&S Microwave Signal Generator.

Note: The computer name can only be changed after protection level 1 is deactivated (see [chapter 5.2.3.14, "Protection"](#), on page 106).

A predefined name is indicated and can be used for network connections.

SCPI command:

`:SYSTEM:COMMunicate:NETWork[:COMMON]:HOSTname` on page 506

Workgroup

Enters the individual windows workgroup name of the R&S Microwave Signal Generator. This parameter is necessary in case the instrument is integrated in a windows network.

Note: The workgroup can only be changed after protection level 1 is deactivated (see [chapter 5.2.3.14, "Protection"](#), on page 106).

SCPI command:

`:SYSTEM:COMMunicate:NETWork[:COMMON]:WORKgroup` on page 506

Address Mode

Selects if the IP address is assigned automatically or manually.

"Auto (DHCP)" The IP address is assigned automatically.
The network used must support automatic assignment of IP address via DHCP or APIPA (Zeroconf) in order to use this function.

"Static" The IP address is assigned manually.

SCPI command:

`:SYSTEM:COMMunicate:NETWork:IPAddress:MODE` on page 506

IP Address

Displays the IP address. To enter the IP address manually, select "Static" Address Mode.

SCPI command:

`:SYSTem:COMMunicate:NETWork:IPADdress` on page 507

Subnet Mask

Displays the Subnet mask. To enter the Subnet mask manually, select "Static" Address Mode.

This number is used together with the IP address to identify the network segment the instrument is in.

SCPI command:

`:SYSTem:COMMunicate:NETWork[:IPADdress]:SUBNet:MASK` on page 507

Default Gateway

Displays the IP address of the default gateway. To enter the default gateway manually, select "Static" Address Mode.

This address identifies the router on the same network as the instrument that is used to forward traffic to destinations beyond the local network.

SCPI command:

`:SYSTem:COMMunicate:NETWork[:IPADdress]:GATeway` on page 507

Restart Network

Shuts down the network connection of the instrument and subsequently re-establishes the connection.

This function can be used to resolve network problems.

Note: Only the connection of the instrument to the network restarts, the network itself is not affected.

SCPI command:

n.a.

5.2.3.11 Display/Keyboard Settings

In the "Display/Keyboard Settings" menu the power-save mode and external keyboard settings are made. It is opened using the SETUP or MENU key under "Environment".

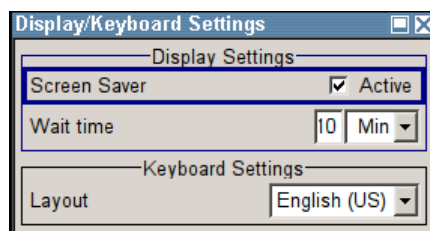
**Screen Saver Active**

Activates/deactivates the screen-save mode of the display.

If activated, the display including backlight is completely switched off after the elapse of the "Wait Time" when no entries via front panel, external mouse or external keyboard are made.

This mode is recommended for preserving the display especially if the instrument is exclusively operated via remote control.

SCPI command:

[:DISPlay:PSAVe\[:STATe\]](#) on page 315

Wait Time

Enters the idle time that must elapse before the display lamp is shut off when no entries are made.

SCPI command:

[:DISPlay:PSAVe:HOLDoff](#) on page 315

Layout (Keyboard)

Selects the keyboard layout for the selected keyboard language.

The assignment of some keys depends on the selected layout and language.

SCPI command:

[:KBOard:LAYout](#) on page 324

[:KBOard:LANGuage](#) on page 324

5.2.3.12 Auxiliary I/O Settings

The "Auxiliary I/O Settings" dialog provides access to the settings for the V/GHz, BLANK and MARKER auxiliary output.

To access this dialog, press the SETUP or MENU key under "Environment".

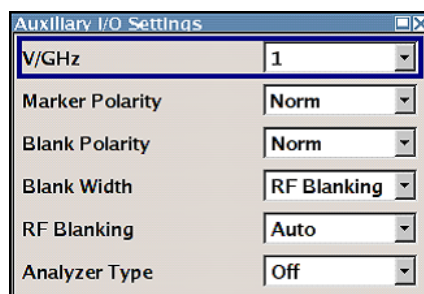

V/GHz

Selects the V/GHz ratio for the V/GHz output. This output provides a voltage which is proportional to the current sweep frequency. The voltage is always available, even with the sweep switched off.

SCPI command:

[:OUTPut:FPRoportional:SCALE](#) on page 335

Marker Polarity

Selects the polarity of the **MARKER** output signal.

The user-programmable marker signal can be used for brightness control of an oscilloscope. The output becomes active when the sweep run has reached the marker. Up to 10 markers can be set to mark positions in the sweep run. The duration of the active signal is equal to the dwell time (DWEELL) of a step.

SCPI command:

[\[:SOURce<hw>\]:SWEep:MARKer:OUTPut:POLarity](#) on page 495

Blank Polarity

Selects the polarity of the Blank marker.

SCPI command:

[:OUTPut:BLANK:POLarity](#) on page 335

Blank Width

Selects the start of the blank marker in relation to the external sweep trigger (blank width).

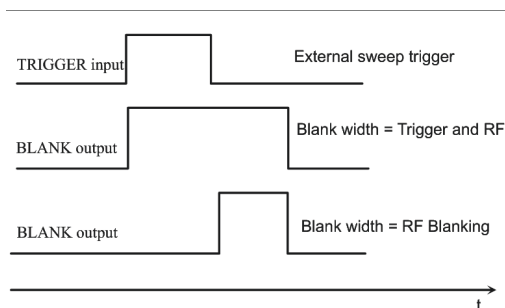

"RF Blanking" The blank marker starts after the external sweep trigger signal.

"Trigger and RF" The blank marker starts with the external sweep trigger signal.

SCPI command:

[:OUTPut:BLANK:WIDTH](#) on page 335

RF Blanking

Selection of the RF blanking method for sweeps with step widths less than 10 MHz.

"Auto" RF blanking only when the step synthesizer switches to the next step (provides a clean RF spectrum).

"On" RF blanking after each step.

"Off" No RF blanking.

SCPI command:

[:OUTPut:BLANK:MODE](#) on page 334

Analyzer Type

Allows to switch the HP8757D/E scalar network analyzer (selection HP8757D/E).

Note: The HP8757D/E has a special control mechanism via GPIB bus. RF blanking is internally set to "Auto". Start and stop frequencies are transferred to the network analyzer. An GPIB command is not available, since it is used for controlling the network analyzer.

"Off" RF blanking as selected under RF blanking is active.

"8757D/E" An additional sawtooth signal from start and stop frequency is output at the Z-AXIS output for control of the HP8757D/E scalar network analyzer.

SCPI command:
n.a.

5.2.3.13 Remote Channel Settings

The "Remote Channel Settings" dialog provides access to the settings for remote control. The dialog is opened using the SETUP or MENU key under "Remote".

Besides the standard GPIB-setting, the selection of one of the possible emulations and a user defined definition of the *IDN and *OPT string is possible.

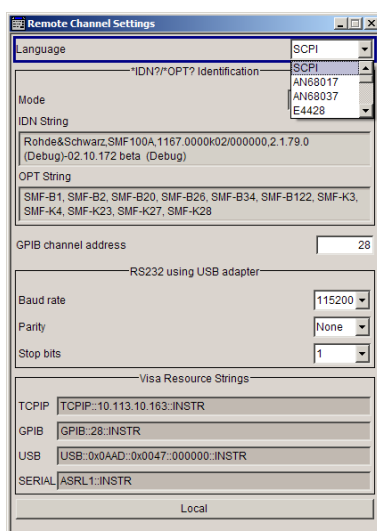

Language

Selects the instrument whose remote command set is emulated by the R&S SMF.

The R&S SMF can also be remote controlled via the command set of several other generators, e.g. of an HP generator. You find the available command sets for the generator in the selection list. This feature allows to replace a generator by an R&S SMF in existing test setups. Refer to the corresponding Application Note at the download area of the product site on the Internet. The Application Note is also provided on the user documentation CD-ROM (included in delivery).

The selected instrument also defines the identification string that is retrieved with query *IDN?. If required, use the parameter "Mode" and "IDN String" to change this string.

As any other parameter, the remote control command set can also be changed remotely by means of the SCPI command `SYST:LANG`. However, this remote control command is enabled only in the instrument's specific SCPI command set, i.e. it is possible to change the command set remotely from the original one (`SYST:LANG SCPI`) to the command set to be emulated but not vice versa.

Note: While working in a emulation mode, the R&S SMF specific command set is disabled, i.e. the SCPI command `SYST:LANG` will be discarded.

To return to the SCPI command set of the R&S SMF, use the appropriate command of the selected command set. If for example a HP generator is emulated, the HP command `EX` returns to the instrument-specific GPIB command set.

SCPI command:

`:SYSTem:LANGuage` on page 513

Identification Mode

Selects the way the instrument identification is performed.

"Automatic" The "IDN String" and the "OPT String" are set automatically for the instrument select with the parameter "Language".

"User Defined" Enables the selection of user definable "IDN String" and "OPT String" for the instrument selected with the parameter "Language".

SCPI command:

`:SYSTem:IDENtification` on page 512

Set to default

Overwrites the user-defined `*IDN` and `*OPT` strings with default strings. The default strings vary depending on the selected emulation mode ([Language](#))

SCPI command:

n.a.

IDN String

Indicates the identification string of the instrument when queried with the common command `*IDN?`.

In addition to the preset values, a user defined identification string can be entered, e.g. to provide individual identification for each generator, like 'MY_R&S SMF' for instance.

SCPI command:

`:SYSTem:IRESpOse` on page 513

OPT String

Indicates the option string of the instrument as queried with common command `*OPT?`.

If a "User Defined" [Identification Mode](#) is selected, a user defined option string can be created, additionally to the automatically created one.

SCPI command:

`:SYSTem:ORESpOse` on page 514 for the user defined OPT String
`*OPT?`

GPIB channel address

Sets the GPIB address of the instrument.

SCPI command:

`:SYSTem:COMMunicate:GPIB[:SELF]:ADDRess` on page 505

RS232 using USB adapter

Requires a USB serial adapter (recommended extra, see data sheet)

Sets the parameters of the serial interface.

Either a RS232 interface or a Bluetooth connection can be used for remote control via the serial interface. The settings are effective for both interfaces (see also [chapter 5.2.3.15, "Security"](#), on page 107).

SCPI command:

```
:SYSTem:COMMunicate:SERial:BAUD on page 508
:SYSTem:COMMunicate:SERial:PARity on page 509
:SYSTem:COMMunicate:SERial:SBITs on page 509
```

Visa Resource Strings

Indicates the visa resource strings, used for remote control of the instrument. A separate string is provided for remote control via the different interfaces.

SCPI command:

```
:SYSTem:COMMunicate:NETWork:RESource on page 507
:SYSTem:COMMunicate:GPIB:RESource on page 508
:SYSTem:COMMunicate:USB:RESource on page 508
:SYSTem:COMMunicate:SERial:RESource on page 508
```

Local (Remote Channel Settings)

Switches the instrument to operate in local control mode.

Switching from remote to local control mode can be also done with one of the following actions:

- manually with the LOCAL key on the front panel
- with the interface command `>L` via the remote-control interface
- with the key combination CTRL + Q.

SCPI command:

```
&GTL
```

5.2.3.14 Protection

This "Protection" dialog provides access to the unlocking of different protection levels. To open this dialog, use the SETUP or MENU key under "Protection".

After the instrument has been switched on, the protection levels 1 to 5 are automatically activated. To deactivate the protection, the correct password has to be entered. With the corresponding check boxes, you can activate the protection again.

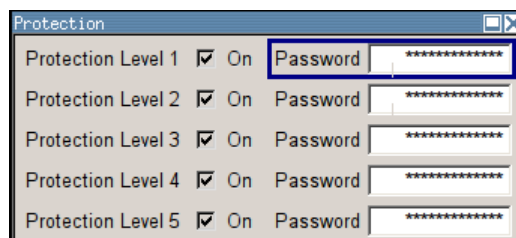

The following functions are protected in the respective levels:

- Protection Level 1
protects against accidental changes to certain settings, such as clock and date, network settings or instrument names, etc. This level is accessible to the user.

- Protection Level 2 provides access to the unlocking of protected service functions. It is accessible to authorized personnel of R&S Service Departments only.
- Protection Level 3-5 are reserved for factory internal use.

Protection Level/Password

Protection Level 1 can be activated to expand the functionality of the internal adjustment and to access the selftests.

The password is 123456.

SCPI command:

`:SYSTem:PROTect<ch>[:STATe]` on page 514

5.2.3.15 Security

The "Security" dialog provides access to the passwords and mass storage security settings. To open this menu, use the SETUP or MENU key under "Protection".

The menu is divided into the password sections and the security settings section. In the password section, the passwords for securing a controlled access to the instrument are defined and changed.

A change of passwords for the operating system and security password requires the entry of the old and new password and the conformation of the new password. All settings are only accepted after the "Change Password" button is pressed.

User Name

Indicates the user name used for access to the Linux operating system and valid for VNC, FTP and SAMBA access.

The user name and password are required for remote access to the instrument via VNC, FTP or SAMBA.

SCPI command:

n.a.

Old Password (User Password)

Enters the currently used user password. The default password is "instrument".

Note: It is highly recommended to change the default user password before connecting the instrument to the network.

New Password (User Password)

Enters the new security password.

The security password may contain decimal characters only.

SCPI command:

n.a.

Confirm Password (User Password)

Enters the new password for conformation.

The new password is only valid after the "Change Password" button is pressed.

SCPI command:

n.a.

Change Password (User Password)

Changes the password accordingly.

SCPI command:

n.a.

Old Password (Security Password)

Enters the currently used security password. The default password is '123456'.

Note: It is highly recommended to change the default security password before connecting the instrument to the network.

The security password is required when changing the status of the USB and LAN interface.

SCPI command:

n.a.

New Password (Security Password)

Enters the new security password.

The security password may contain decimal characters only.

SCPI command:

n.a.

Confirm Password (Security Password)

Enters the new password for conformation.

The new password is only valid after the "Change Password" button is pressed.

SCPI command:

n.a.

Change Password (Security Password)

Changes the password accordingly.

SCPI command:

n.a.

USB Device

Enables/disables the USB interfaces.

The instrument does not recognize any device connected to the USB interface when the interface is disabled.

The setting requires the entry of the security password and is only accepted after the "Accept" button is pressed.

SCPI command:

n.a.

LAN Connection

Enables/disables the LAN interfaces.

It is not possible to access the instrument via LAN while the LAN connection is disabled.

An enabled LAN Connection is a prerequisite for the remote control of the instrument via VNC, FTP or SAMBA.

The setting requires the entry of the security password and is only accepted after the "Accept" button is pressed.

SCPI command:

n.a.

Annotation Frequency

Enables/disables the display of the currently used frequency in the header of the instrument.

The setting requires the entry of the security password and is only accepted after the "Accept" button is pressed.

SCPI command:

n.a.

Annotation Amplitude

Enables/disables the display of the currently selected level in the header of the instrument.

The setting requires the entry of the security password and is only accepted after the "Accept" button is pressed.

SCPI command:

n.a.

Display

Enables/disables the display.

If this parameter is disabled, the instrument cannot be operated manually via the user interface, i.e. display, front panel keys and external keyboard are disabled. Remote control of the instrument is enabled.

The setting requires the entry of the security password and is only accepted after the "Accept" button is pressed.

SCPI command:

:[SYSTem:DLOCK](#) on page 510

Keyboard

Enables/disables an external keyboard and mouse connected to the instrument, the front panel keys of the instrument, the rotary knob and the on-screen keyboard.

If this parameter is disabled, the instrument cannot be manually controlled but changes in the settings are shown on the display. Remote access and remote control are enabled.

The setting requires the entry of the security password and is only accepted after the "Accept" button is pressed.

To enable the keyboard, type the security password on the external keyboard or use the `SYST:KLOC OFF` command over remote control.

SCPI command:

:[SYSTem:KLOCK](#) on page 513

Security Password

Enters the password that is required to enable or to disable the settings protected by a security password. Default is '123456'.

Note: It is highly recommended to change the default security password before connecting the instrument to the network.

All settings are only accepted after the "Accept" button is pressed.

SCPI command:

n.a.

Accept - Security

Accepts a new entry or selection and changes the settings accordingly.

SCPI command:

n.a.

Bluetooth Pin

Requires a USB Bluetooth adapter (recommended extra, see data sheet).

Enters the Bluetooth pin of an external Bluetooth device. The pin is required to enable remote control via an external Bluetooth device.

The interface parameters are identical to the RS232 interface parameters and can be set in the "Remote Channel Settings" dialog (see "[RS232 using USB adapter](#)" on page 105).

SCPI command:

n.a.

5.2.3.16 Save/Recall

The "Save/Recall" submenu can also be called up with the FILE key and is therefore described in the section of this key (see [chapter 5.2.8, "Storing and Loading Instrument Data - File Key"](#), on page 117).

5.2.3.17 Factory Preset

The "Factory Preset" dialog provides a function to reset the instrument's settings to their factory state. This function is activated by pressing the "Execute Factory Preset" button.

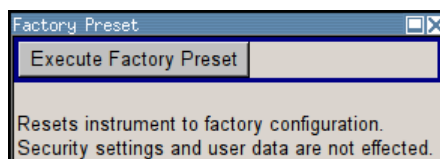

Factory Preset

Reset the instrument's settings to their factory state.

Note: Since Factory Preset resets the Remote Channel and network settings to the default values, executing Factory Preset via remote control terminates the connection to the instrument, if these settings had been configured to values different to the default ones!

The factory preset function resets nearly all instrument settings. In addition to the regular preset by means of the PRESET key, a "Factory Preset" resets also the following values:

- Reference frequency settings ("Ref Oscillator" menu)
- Power on settings ("Level/EMF" menu)
- Network settings including hostname ("Setup" menu)
- Remote Channel settings including GPIB address ("Setup" menu)
- Start/Stop Gui Update ("Setup" menu)
- Display and keyboard settings ("Setup" menu).

To maintain security, password settings and all settings protected by these passwords like disabled USB and LAN connections are not changed.

Not affected by the "Factory Preset" are also user data, lists or instrument settings files, created for example by means of the Save/Recall function.

SCPI command:

:SYSTem:FPReset on page 310

5.2.3.18 Help

The "Help" dialog offers comprehensive online help for the R&S Microwave Signal Generator. A desired topic can be selected via the table of contents (select "Manual") or the index (select "Index").

For context-sensitive information about a marked parameter, press the HELP key. For a description of the "Help" menu, refer to the section covering to the HELP key (see [chapter 5.2.7, "Help System - Help Key"](#), on page 116).

5.2.4 Switching to Manual Control - Local Key

In remote control mode a status message appears in the display header. The rest of the display remains unchanged and shows the current instrument status, i.e. the status which exists under the remote control settings. The instrument can be operated (e.g. menus can be opened). However, it is not possible to enter or change values.

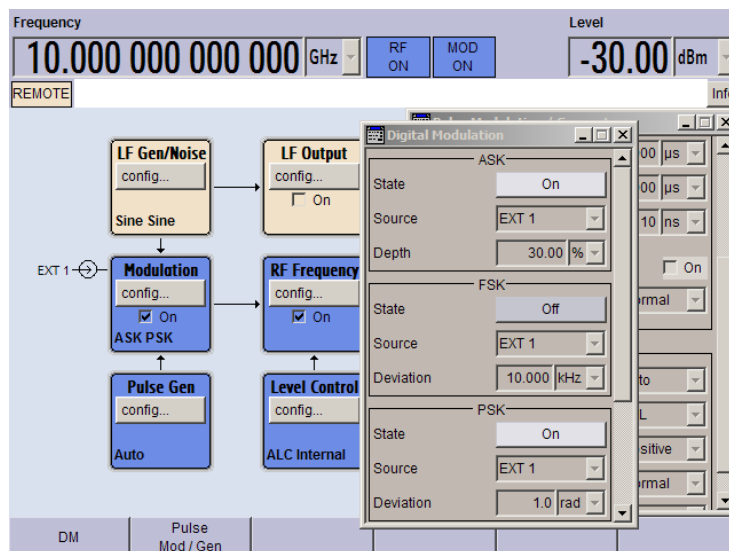

The status message additionally indicates whether the LOCAL key is disabled or enabled.

If the "REMOTE" status message is shown, the LOCAL key switches the instrument from remote control to manual control. The current command must be fully processed before the mode is switched, otherwise the instrument switches immediately back to remote control.

If the "REM-LLO" status message is displayed, the instrument can be switched from remote control to manual control by means of remote control only (e.g. with the Visual Basic command `CALL IBLOC (generator%)`); the LOCAL key is disabled. The key is disabled by remote control with the command LLO.

When switching from remote to manual control, the display update suppression function, if active ("SETUP > GUI Update" is Off), is automatically deactivated ("SETUP > GUI Update" is On).

5.2.5 Generating a Hard Copy of the Display

The HCOPY key opens a window for configuring the hardcopy setting, like output file format, path and file name.

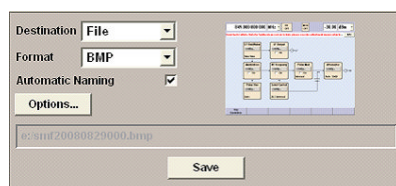

5.2.5.1 Hardcopy Dialog

Destination

Indicates that the hardcopy is stored in a file (see also "File Options" on page 114).

SCPI command:

`:HCOPY:DEVice` on page 318

Options

Opens the Hardcopy Options dialog for configuring the hardcopy parameters (see "File Options" on page 114).

SCPI command:

n.a.

File

Some configuration parameters are already offered in the Hardcopy dialog. All configuration parameters are available in "File Options" on page 114.

Automatic Naming

Activates, deactivates automatic generation of the file name. Automatic naming is configured in the "Options..." submenu, see "File Options" on page 114.

SCPI command:

`:HCOPY:FILE[:NAME]:AUTO:STATE` on page 323

File Info

Indicates the file name. The file name can be entered either manually via the file manager (button "File...") or generated automatically (Automatic naming checkbox). Automatic naming is configured in the "Options..." submenu.

SCPI command:

`:HCOPY:FILE[:NAME]` on page 319

`:HCOPY:FILE[:NAME]:AUTO:FILE` on page 320

5.2.5.2 Hardcopy Options

This section describes the "Hardcopy Options" dialog.

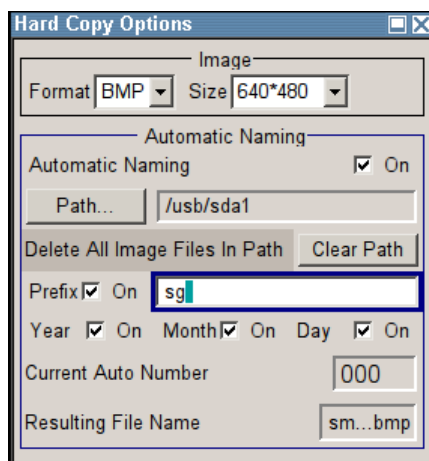

File Options

Dialog for setting the file parameters.

"Size" Defines the size of the bitmap in terms of pixels. The first value of the size setting defines the width, the second value the height of the image.

SCPI command:

[:HCOPY:IMAGe:SIZE](#) on page 323

"Format" Selects the image format. Several bitmap formats are available.

SCPI command:

[:HCOPY:DEVice:LANGUage](#) on page 318

"Automatic Naming" Determines the rules to create the file names and sets the directory the files are saved into.

As default the automatically generated file name is composed of:
 <Path>/<Prefix><YYYY><MM><DD><Number>.<Format>

Each component can be deactivated/activated separately to individually design the file name. The resulting file name is indicated.

"Path..." Opens the "Select Hard Copy Destination Path" dialog to select a path for storing the hardcopy.

Note: For selecting the destination path a file name must be entered as well. Otherwise the error message "The name of a list may not be empty" is displayed and the selection will be canceled.

Directory, path and file name are displayed in the infoline right to the "Path" button.

SCPI command:

[:HCOPY:FILE\[:NAME\]:AUTO:DIRectory](#) on page 319

[:HCOPY:FILE\[:NAME\]:AUTO](#) on page 319

"Clear Path" Deletes all image files with extensions bmp, img, png, xpm and csv in the directory set for automatic naming.

Before deleting the image files a warning message is displayed requiring the confirmation.

SCPI command:

[:HCOPY:FILE\[:NAME\]:AUTO:DIRectory:CLEar](#) on page 320

"Prefix" Activates the usage of the prefix in the automatic file name. The prefix is entered in the field to the right of checkbox.

SCPI command:

`:HCOPY:FILE[:NAME]:AUTO[:FILE]:PREFIX:STATE` on page 322

"Enter prefix" Enters the prefix for the automatically generated file name. The use of the prefix is activated in the checkbox to the left.

SCPI command:

`:HCOPY:FILE[:NAME]:AUTO[:FILE]:PREFIX` on page 322

"Date - Year / Month / Day" Defines the components of the automatically generated file name. The selectable parameters are year, month and day. If activated the current year, month or day used in the file name.

SCPI command:

`:HCOPY:FILE[:NAME]:AUTO[:FILE]:YEAR:STATE` on page 323

`:HCOPY:FILE[:NAME]:AUTO[:FILE]:MONTH:STATE` on page 321

`:HCOPY:FILE[:NAME]:AUTO[:FILE]:DAY:STATE` on page 321

"Current Auto Number" Indicates the number which is used in the automatically generated file name.

Note: On initially switching on the device the number will be reset to the lowest possible value. Starting with number 0 the output directory will be scanned for already existing files. As long as files with the same name are existing the number will be increased by 1. The number will be automatically set to a number so that the resulting file name will be unique within the selected path. The current number will not be saved in the save recall file but will be temporarily stored within the database. On subsequent saves the number will be increased.

SCPI command:

`:HCOPY:FILE[:NAME]:AUTO[:FILE]:NUMBER` on page 321

"Resulting File Name" Indicates the automatically generated file name.

SCPI command:

`:HCOPY:FILE[:NAME]:AUTO:FILE` on page 320

Save

Triggers the generation of a hardcopy.

SCPI command:

`:HCOPY[:EXECute]` on page 318

5.2.6 Messages - Info Key

The INFO key opens a window containing a detailed description of every message displayed in the info bar, see [chapter 4.2.3, "Info Window"](#), on page 65 and [chapter 9, "Error Messages"](#), on page 527.

5.2.7 Help System - Help Key

The HELP key opens a browser window containing a context-sensitive description of the highlighted parameter.

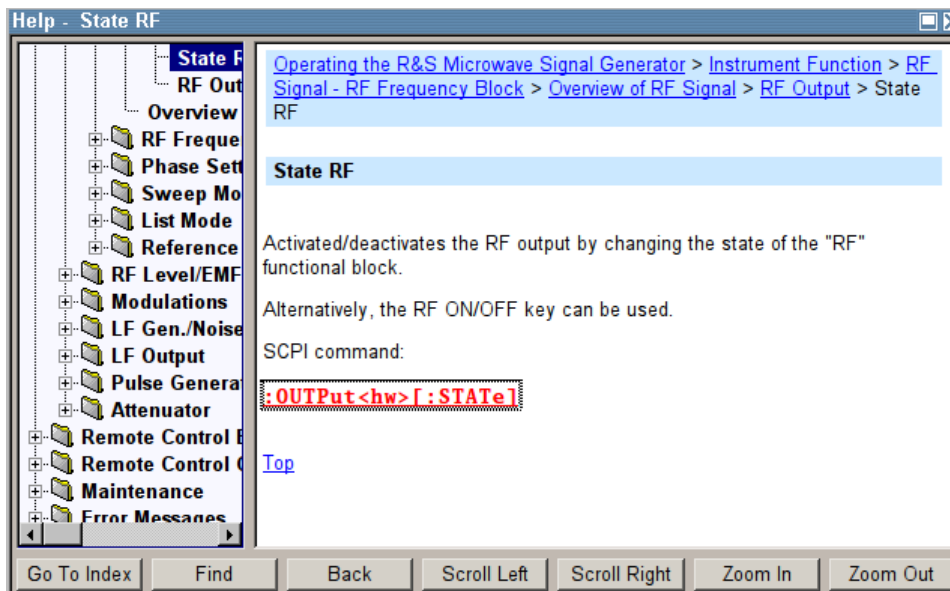

The context-sensitive page which is opened with the HELP key is part of a comprehensive help system. It is possible to move from this context-sensitive page to any page of the help system. The following navigation aids are available:

- Internal links in the text
They open pages which are directly linked to the described function. In this way it is possible, for example, to call up the description of the GPIB command for any particular function.
- Previous/Next links
The Previous/Next links allow scroll through the help pages. The sequence of the described functions corresponds to their position in the menus.
- Back button
The Back button calls up the page last viewed.
- Contents in the navigation panel
The contents list is used to open the individual help pages. It has a hierarchical structure. The highlighted line indicates where the currently displayed page is within the contents list.
- Index in the navigation panel
The index is used to call up all pages which contain the selected entry. The index has an alphabetical structure and also contains all GPIB commands.
- Find
The find function allows you to look for freely selectable terms in all help pages. A list of the pages containing the entered term is displayed as the search result. The search can be limited to words in the page title to increase the number of hits.

The softkeys are used to determine the entry focus for front panel operation, to select the content of the navigation window and to change the font size. To determine the entry

focus for front panel operation the Cursors UP/Down are used. The links are highlighted in blue, and can be selected and called up using the rotary knob.

5.2.8 Storing and Loading Instrument Data - File Key

The R&S SMF allows complete instrument settings to be stored in files on the Compact-Flash™ Card.

Defined and complex instrument settings can then be reproduced at any time by loading this data. If required, these settings can be loaded to various signal generators.

The corresponding menu is available under "Save/Recall" in the "Setup" menu or accessible by means of the FILE key. The instrument settings are saved in files which can be stored in data directories.

Additionally there are intermediate memories in which the current instrument setting can be stored and then called up again by just pressing a key. This provides fast switching between different instrument settings.

Only settings which differ from the preset values and configuration data for the operating elements (e.g. window positions) are stored. As a result the files remain relatively small. Furthermore, instrument settings can easily be transferred between different equipped signal generators since the files contain only relevant information. When loaded, the referenced settings are implemented and all non-referenced parameters are set to the associated preset values.

If list data is part of the instrument settings, e.g. a list of user correction data, a reference to this list is stored, not the list itself. The list is reactivated when the associated settings are loaded, but the list may have been modified or deleted in the meantime or may not be available on a different instrument. If the list has been modified, the new entries will be used. An error message appears if an attempt is made to access a non-existing list or to activate settings which are not supported by the instrument.



- Network settings and remote settings are not saved and restored.
 - Lists are stored and loaded in the appropriate menus. For example, the user correction data list is created and stored in the "User Correction" menu.
-

When loading an instrument setting, it is possible to select whether the current frequency and level setting is to be retained or whether the stored settings are to be activated. It is possible to delete stored instrument settings. A file can be copied by loading it with "Recall" and then storing it under a new name.

Settings can be transferred easily between instruments with different equipment options and/or firmware versions because only the settings which differ from the preset values are affected. When settings are loaded, only those which are possible on the instrument are implemented. Error messages indicate the settings which cannot be implemented.

The stored file is transferred from one instrument to another using the memory stick.

General file management functions such as copying and moving data are available in the "File Manager" dialog.

5.2.8.1 File Menu

The settings available in the File menu "Save/Recall" depend on the operation selected under "Select Operation".



For more information, see [chapter 4.7.1, "File Select Dialog"](#), on page 80.

Select Operation

Selects the file function.

- "Save..." Calls the menu for storing the current instrument setting (see [chapter 5.2.8.2, "Storing Instrument Settings"](#), on page 118).
- "Recall..." Calls the menu for calling up a stored instrument setting (see [chapter 5.2.8.3, "Loading Instrument Settings"](#), on page 119).

5.2.8.2 Storing Instrument Settings

If "Save" is selected under "Select Operation", the File menu provides options for storing the current instrument setting in a file.

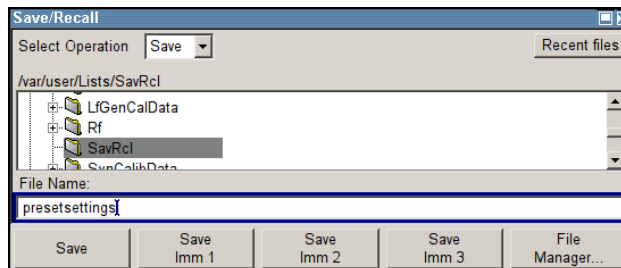

Recent files

Displays the files last used.

SCPI command:

n.a.

Directory

Selects the directory in which the file is to be stored.

The window opposite lists all settings files in this directory.

A new directory can be created in the "File Manager" dialog.

SCPI command:

[:MMEMory:CDIRectory](#) on page 328

File List

Displays the files which are in the selected directory.

If a file is highlighted, it is overwritten when the file is stored.

SCPI command:

[:MMEMory:CATalog](#) on page 328

File Name

Enter the file name of the file without file extension. This file is then created.

SCPI command:

n.a.

Save

Stores the current instrument settings under the specified path.

SCPI command:

*[SAV](#) on page 308

:[MMEMory:STORe:STATe](#) on page 332

Save Immediate x

Stores the current instrument setting in one of the three intermediate memories.

These instrument settings are retained until a different instrument setting is stored in the intermediate memory. When the instrument is switched off, the contents of the intermediate memories are retained.

SCPI command:

*[SAV](#) on page 308

File Manager

Calls the "File Management" menu.

Directories can be created and files managed in this menu (see [chapter 5.2.8.4, "File Manager"](#), on page 121).

SCPI command:

n.a.

5.2.8.3 Loading Instrument Settings

If "Recall" is selected under "Select Operation", the "File" menu provides options for loading complete instrument settings. Here it is possible to select whether the current or stored frequency and level settings are to be used.

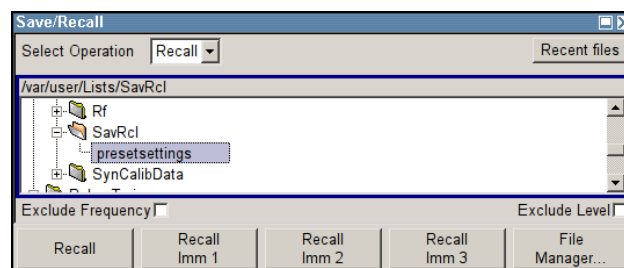
**Recent data sets**

Displays the files last used. The entire path is shown.

If the desired file is in the list, it can be selected.

SCPI command:

n.a.

Directory

Enter the directory in which the file with the instrument setting to be loaded is located.

The "Selected file" window lists all the files in this directory.

SCPI command:

`:MMEMory:CDIRectory` on page 328

File List

Selects the file with the desired instrument configuration.

SCPI command:

`:MMEMory:CATalog` on page 328

Exclude Frequency

The current frequency is retained when a stored instrument setting is loaded.

SCPI command:

`[:SOURce<hw>] :FREQuency [:CW | :FIXed] :RCL` on page 414

Exclude Level

The current level is retained when a stored instrument setting is loaded.

SCPI command:

`[:SOURce<hw>] :POWer [:LEVel] [:IMMediate] :RCL` on page 464

Recall

Load the selected configuration.

If an instrument setting in which a sweep was activated is stored, the sweep is started when the recall command is called.

If an instrument setting which accesses lists is stored, this list is also loaded.

If the list has been deleted in the meantime, an error message appears when the instrument setting is loaded. If the list has been overwritten in the meantime, the new entries will be used.

SCPI command:

`:MMEMory:LOAD:STATe` on page 331

`*RCL` on page 308

Recall Immediate x

Loads the selected configuration from one of the three intermediate memories.

If an instrument setting in which a sweep was activated is stored, the sweep is started when the recall command is called.

If an instrument setting which accesses lists is stored, this list is also loaded.

If the list has been deleted in the meantime, an error message appears when the instrument setting is loaded. If the list has been overwritten in the meantime, the new entries will be used.

A message appears if no instrument configuration is stored in this memory.

SCPI command:

`*RCL` on page 308

5.2.8.4 File Manager

The "File Manager" dialog provides all the functions required for file management. Directories can be created, and files copied, deleted and moved between the directories on the devices (CompactFlash™ Card and memory stick). A USB stick is automatically recognized when connected to the instrument and the USB directory 'usb/ISB_DISK (data dir)' indicated in the file manager.

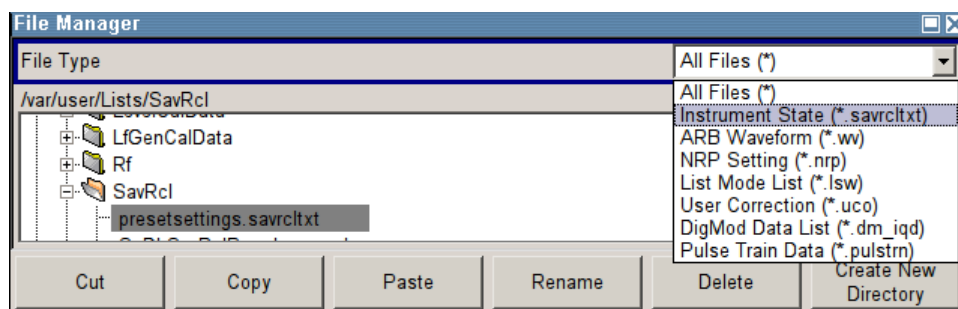

For more information, see [chapter 4.7.2, "File Manager"](#), on page 81.

File Type

Selects the file types to be indicated. If a file type with a specific file extension is selected only files with this extension are indicated in the selected directory.

SCPI command:

n.a.

Directory and File Name

Selects the directory in which the file to be deleted or copied is located. The window lists all files in this directory. The file to be deleted or copied can be highlighted. The path is indicated above the directory window.

SCPI command:

[:MMEMory:CDIRectory](#) on page 328

Cut

Cuts the selected file. It can be pasted into a different directory using the "Paste" button.

SCPI command:

[:MMEMory:DELeTe](#) on page 330

Copy

Copies the selected file. It can be pasted into a different or the same directory using the "Paste" button. When pasting the file into the same directory file name `Copy of <file name>` is given automatically. When pasting the file into a different directory, the original file name is kept.

SCPI command:

[:MMEMory:COpy](#) on page 329

Paste

Pastes the file that has been copied or cut before.

SCPI command:

n.a.

Rename

Renames the selected file or directory. The new name can be entered in the "New File-name" dialog.

SCPI command:

[:MMEMory:MOVE](#) on page 331

Delete

Deletes the selected file. Before the file is deleted, a message appears prompting the user to confirm deletion of the file.

SCPI command:

[:MMEMory:DELeTe](#) on page 330

Create New Directory

Creates a new directory. The name of the new directory can be entered in the "New Directory" dialog.

Note: When the subdirectory is entered, it is possible to enter an absolute path name (e.g. /var/USER/MEAS) or the path relative to the current directory (e.g. ../MEAS).

The directory is created as a subdirectory in the selected level.

SCPI command:

[:MMEMory:MDIRectory](#) on page 331

5.3 RF Signal - RF Frequency Block

5.3.1 Overview of RF Signal

Settings for the RF output signal are made under "RF Frequency". These settings can be accessed in the block diagram by way of the "RF Frequency" function block, or by means of the menu with the same name which is opened using the MENU key.

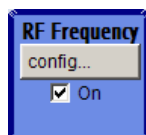

The function block is available for the basic unit R&S SMF without any additional equipment options.

5.3.1.1 RF Output

To activate and deactivate the RF output signal, use one of the following alternatives:

- directly using the TOGGLE ON/OFF key (the function block must be highlighted beforehand)
- by means of the RF ON/OFF key (the current entry focus is irrelevant)
- by changing the state of the "RF Frequency" functional block (see "State RF" on page 123)
- by enabling/disabling the RF in the "Configure" menu of the "RF" block (see "RF Output State" on page 123).

The current state of the RF output (activated and deactivated) is indicated in the block diagram by means of the different block color and the status of the "On" checkbox.

The symbol for the signal output is displayed at the end of the block diagram, assigned to the attenuator block. The disconnected connection to the output is additionally shown when the output is deactivated.

State RF

Activated/deactivates the RF output by changing the state of the "RF" functional block. Alternatively, the RF ON/OFF key can be used.

SCPI command:

`:OUTPut<hw>[:STATe]` on page 335

RF Output State

Activated/deactivates the RF output by

- enabling/disabling the RF in the "Configure" dialog of the "RF" block.
- by enabling/disabling the RF State in the "RF Level/EMF/ALC/UCOR" dialog.

SCPI command:

`:OUTPut<hw>[:STATe]` on page 335

5.3.1.2 Overview of the RF Signal Settings

The CW, Sweep and List modes are available for generating the RF signal.

- **CW**
The RF signal is generated with the set frequency and level. This is the default mode.
- **Sweep**
The RF signal is generated as a sweep with the set parameters.
It is not possible to activate frequency, level and LF sweep simultaneously.
- **List Mode**
The RF signal is generated on the basis of a list of predefined frequency and level values. The duration of the individual steps can be predefined.

Instruments connected downstream can be taken into consideration when setting the frequency and level by entering a frequency and/or level offset.

Automatic level control ("ALC") ensures maximum level accuracy.

User-specific lists which contain level correction values for any frequency range ("User Correction") can be created to, for example, compensate the cable attenuation in a test assembly setup.

The R&S Microwave Signal Generator generates the RF signal in unmodulated or analog form. The signal generator is equipped therefore with the following sources for analog modulations:

- two internal LF generators (option R&S SMF-B20)
- an internal pulse generator (option R&S SMF-K23)
- a noise generator (option R&S SMF-B20)
- the external modulation inputs EXT 1 and EXT 2 are available as the source for analog and/or digital modulations (option R&S SMF-B20).

An external trigger signal for the sweeps and the List mode can be provided at the TRIGGER input or AUX connector.

The input REF IN is used to input an external instrument reference, and the output REF OUT serves as the output of the reference frequency (internal or external).

5.3.2 RF Frequency Settings

The value of the RF frequency is displayed in the header of the instrument's display ("Freq"). This field provides the direct input of the RF frequency. Alternatively, you can enter the RF frequency in the "Frequency/Phase" dialog.

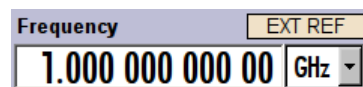

Be aware that the displayed RF frequency in the header, and the RF output frequency, entered in the "Frequency/Phase" dialog can be different, as explained in the following section.

5.3.2.1 RF Frequency vs. RF Output Frequency

The signal generator offers the possibility, to take additional frequency modifications of a downstream instrument into consideration, such as an offset set by a mixer, or a multiple of the frequency by a frequency multiplier. The R&S SMF indicates the resulting frequency, including offset and multiplication factor in the header of the screen. I.e. the indicated frequency corresponds to the frequency at the output of the downstream instrument. However, the frequency at the RF output of your signal generator always corresponds to the frequency set in the "Frequency/Phase" dialog.

In this dialog, you can also enter the values of the downstream instrument.

A set frequency offset is indicated by the "FREQ OFFSET/MULTIPLIER" status message.

The correlation between the RF frequency, the RF output frequency and the frequency offset is as follows:

"Freq" (in header) = "RF output frequency" (Frequency in dialog) * "Multiplier" factor (Multiplier in dialog) + "Freq offset" (Offset in dialog)

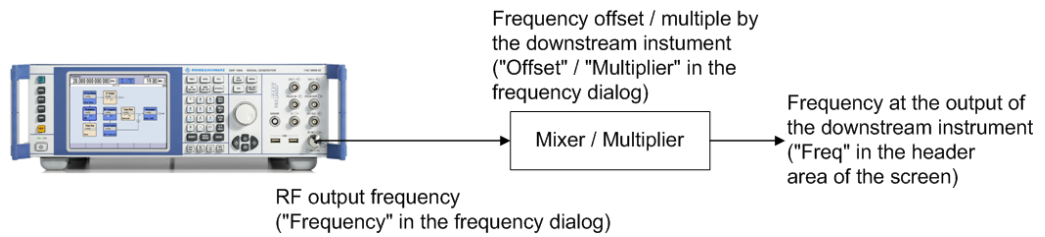

5.3.2.2 Configuring RF Frequency

To change the RF frequency, press the **FREQ** key and enter the desired frequency. Changes to the RF frequency have an immediate effect (without confirmation with the **ENTER** key) on the output signal.

RF Freq

Enters the RF frequency, considering the frequency offset.

Note: The SCPI command sets the level of the "Freq" display, i.e. an entered frequency offset and multiplier factor are taken into consideration in the frequency value.

SCPI command:

[:SOURce<hw>] :FREQuency [:CW | :FIXed] on page 413

5.3.2.3 Frequency Menu

In the combined "Frequency/Phase" dialog, you can enter the frequency, the frequency offset and multiplication factor of a downstream instrument, set the step width for the frequency entry using the rotary knob, and set the phase for the RF output signal.

To open the "Frequency/Phase" dialog, select "RF Frequency > Configure > Frequency" or use the **MENU** key under "RF Frequency".

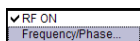

The "Frequency/Phase" dialog is divided into the several sections.

Frequency and offset of the RF output signal are set in the "Frequency Settings" section in the upper part of the dialog. In addition, the multiplier factor of an externally connected multiplier is specified.

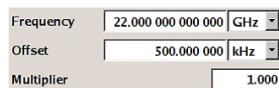

The step width which is used when setting the frequency using the rotary knob (with "Variation Active On") is set in the "User Variation" section.

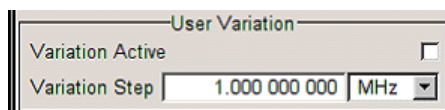

The phase of the output signal can be changed in the "Phase Settings" section. The "Phase Settings" menu is described in [chapter 5.3.3, "Phase Settings"](#), on page 127.

Frequency Settings

The frequency, offset and multiplier factor are set in the top section of the menu.

Frequency - RF Signal

Sets the RF frequency of the RF output connector. The frequency entered and displayed here corresponds to the frequency at the RF output, i.e. any offset entry is not taken into consideration.

Note: The SCPI command `SOUR:FREQ` sets the frequency of the "FREQ" display, i.e. the frequency containing offset and multiplier.

SCPI command:
n.a.

Frequency Offset - RF Signal

Sets the frequency offset relative to the RF frequency. The frequency offset of a downstream instrument (e.g. a mixer) is entered.

The entry does not change the value of the RF frequency at the RF output. It only changes the RF frequency displayed in the display header. The value of the RF frequency in the header corresponds to the frequency at the output of the downstream instrument.

SCPI command:
[\[:SOURce<hw>\]:FREQuency:OFFSet](#) on page 416

Multiplier - RF Signal

Sets the multiplication factor for the RF frequency.

In the frequency field of the status bar, the instrument adjusts its frequency display according to the set multiplication factor. This frequency value shows the frequency at the output of the downstream multiplier. The entry does not change the RF frequency at the RF output of the R&S SMF.

SCPI command:
[\[:SOURce<hw>\]:FREQuency:MULTiplier](#) on page 416

User Variation

If the frequency is set using the rotary knob, the step width is defined in the "User Variation" section.

Variation Active - RF Signal

Activates the user-defined step width used when varying the frequency value with the rotary knob.

"ON"	The frequency value set with the rotary knob is varied using the user-defined step width which is entered under "Variation Step".
"OFF"	The frequency value set with the rotary knob is varied in steps of one unit at the cursor position (standard operating mode).

SCPI command:
[\[:SOURce<hw>\]:FREQuency:STEP:MODE](#) on page 418

Variation Step - RF Signal

Sets the user-defined step width. This step width is used when entering the RF frequency using the rotary knob. Frequency variation with this step width must also be activated with "Variation Active".

SCPI command:

[\[:SOURce<hw>\]:FREQuency:STEP\[:INCRement\]](#) on page 418

5.3.3 Phase Settings

The phase of the RF output signal can be changed in the "Phase Settings" section of the "RF Frequency/Phase" menu.

5.3.3.1 Phase Menu

The phase of the RF output signal can be changed in the Phase Settings section. To open the "Frequency/Phase" dialog, select "RF Frequency> Configure > Frequency/Phase" or use the MENU key under "RF Frequency".

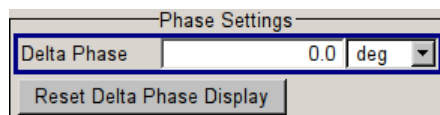
**Delta Phase - RF Signal**

Sets the phase of the RF signal. The current phase of the signal is used as the reference. This function allows, for example, the phase of the output signal to be synchronized with the phase of a signal from a second signal generator.

SCPI command:

[\[:SOURce<hw>\]:PHASe](#) on page 457

Reset Delta Phase Display - RF Signal

Resets delta phase value. The set phase is adopted as the new current phase, i.e. the delta phase value is reset to 0.

SCPI command:

[\[:SOURce<hw>\]:PHASe:REFerence](#) on page 458

5.3.4 Sweep Mode**5.3.4.1 Overview**

The R&S Microwave Signal Generator offers four different sweep types (RF frequency sweep, RF level sweep, LF frequency sweep, and LF level sweep) to be activated alternatively. Each type has 5 modes which differ with respect to the sweep cycle mode (continuous, individual and step-by-step) and triggering mode (automatic, internal and external).

Option R&S SMF-K4 enables analog ramp sweep mode. This mode corresponds to the analog sweep of classic sweep generators, except that the sweep is fully synchronized over the complete range. In conjunction with scalar network analyzers or suitable spectrum analyzers, realtime adjustment of microwave filters can be performed, for example.

To mark important frequency ranges such as filter bandwidths or the position of attenuation poles, the R&S SMF has 10 user-selectable frequency markers which can be output as pulse markers at the marker output (TTL level) or alternatively modulated on the RF level as level markers (level reduction of 1 dB).



Sweeps and List mode can not be activated simultaneously, they deactivate each other.

Setting a sweep

A sweep is set in five basic steps which are shown below taking a frequency sweep as an example.



The LF frequency sweep is activated and configured in the "LF Gen./Noise" block.

1. Set the sweep range ("Start Freq" and "Stop Freq" or "Center Freq" and "Span").
2. Select linear or logarithmic sweep spacing ("Spacing").
3. Set the step width ("Step Lin/Log") and dwell time ("Dwell Time").
4. Activate the sweep ("Mode" to Auto, Single, Step or Extern Single, Extern Step).
5. Trigger the sweep, except for Auto mode ("Execute Single Sweep", Current Frequency or External Trigger Signal).

The different Sweep dialogs are activated as follows:

- The **RF frequency sweep** is activated in the "RF Frequency" block, see [chapter 5.3.4.2, "RF Frequency Sweep"](#), on page 129.
- The **RF level sweep** is activated in the "Level Control" block, see [chapter 5.4.4, "RF Level Sweep"](#), on page 153.
- The **LF frequency sweep** is activated and configured in the "LF Gen./Noise" block, see [chapter 5.6.3, "LF Frequency Sweep"](#), on page 239.
Note: The "LF Gen./Noise" block is available with the option R&S SMF-B20.
- The **LF level sweep** is activated in the "LF Output" block, see [chapter 5.7.2, "LF Level Sweep"](#), on page 249.
Note: The "LF Output" block is available with the option R&S SMF-B20.



It is recommended to switch off the GUI update for optimum sweep performance especially with short dwell times (see [chapter 5.2.3.5, "Gui Update"](#), on page 96).

5.3.4.2 RF Frequency Sweep

The dialog is used to activate and configure a sweep for the RF frequency.

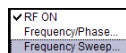

To open the "Frequency Sweep" dialog, select "RF Frequency > Configure > Frequency Sweep" or use the menu tree of the MENU key under "RF Frequency".

In the top section of the menu, the RF sweep mode is activated and the sweep mode is selected.

The buttons are used to reset the RF sweep (all sweep modes) or to execute the RF sweep ("Single" mode).

The sweep range, sweep spacing and dwell time are set in the bottom section.

The very fast ramp sweep can be activated in this section. The button "Edit Marker" opens the subdialog for configuring the sweep markers.

The sweep range of the RF sweep can be entered in two ways, either by entering the "Start" and "Stop" value or by entering the "Center" and "Span".

The two sets of parameters influence each other in the following way:

- "Start Freq" = "Center Freq" - "Span"/2
- "Stop Freq" = "Center Freq" + "Span"/2
- "Center Freq" = ("Start Freq" + STOP FREQ)/2
- "Span" = "Stop Freq" - "Start Freq"

RF Frequency Sweep Settings

State - Frequency Sweep

Activates/deactivates RF sweep mode.

Note: Activating the RF-Sweep mode automatically disables other sweep modes, and the list mode.

SCPI command:

[:SOURce<hw>] :FREQuency:MODE on page 415

Mode - Frequency Sweep

Selects the sweep instrument operating mode and the sweep mode.

"Auto" Sets an automatic repeated sweep cycle. If a different sweep mode was activated prior to the "Auto" mode, the cycle continues from the current sweep setting.
The "Reset Sweep" button resets the sweep to the start frequency.

Example:

```
SOUR:SWE:FREQ:MODE AUTO
TRIG:FSW:SOUR AUTO
SOUR:FREQ:MODE SWE
```

"Single" Sets a single sweep cycle. The sweep is triggered by the "Execute Single Sweep" button.
If a different sweep mode was activated prior to the "Single" mode, the current sweep is stopped. The "Single" sweep always starts at the start frequency when triggered.
The "Reset Sweep" button resets the sweep to the start frequency.

Example:

```
SOUR:SWE:FREQ:MODE AUTO
TRIG:FSW:SOUR SING
SOUR:FREQ:MODE SWE
SOUR:SWE:FREQ:EXEC
```

"Step" Sets a step-by-step sweep cycle.
If this mode is activated, the cursor moves to the value displayed for "Current Freq". Any variation to the "Current Freq" value triggers a sweep step. The step width is set below at entry field "Step Lin" or "Step Log".
If a different sweep mode was activated prior to the "Step" mode, the current sweep is stopped. The "Step" sweep starts at the current RF frequency when triggered.
The "Reset Sweep" button resets the sweep to the start frequency.

Example:

```
SOUR:SWE:FREQ:MODE MAN
SOUR:FREQ:MODE SWE
SOUR:SWE:FREQ:SPAC LIN
SOUR:SWE:FREQ:STEP:LIN 0.5E4
SOUR:FREQ:MAN 1GHz
```

The value entered with command `SOUR:SWE:FREQ:STEP:LIN|LOG` sets the step width.

The value entered with command `SOUR:FREQ:MAN` has no effect, the command only triggers the next sweep step. However, the value has to be in the currently set sweep range (start to stop). In remote control only a step-by-step sweep from start to stop frequency is possible.

"Extern Single" Sets a single sweep cycle. The sweep is triggered by an external trigger signal.
 If a different sweep mode was activated prior to the "Extern Single" mode, the current sweep is stopped. The "Extern Single" sweep always starts at the start frequency when triggered.
 Refer to the description of the rear panel for information about the connectors for external trigger signal input (see [chapter 2.2, "Rear Panel Tour"](#), on page 22).
 The "Reset Sweep" button resets the sweep to the start frequency.

Example:

```
SOUR:SWE:FREQ:MODE AUTO
TRIG:FSW:SOUR EXT
SOUR:FREQ:MODE SWE (External trigger)
```

"Extern Step" Sets a step-by-step sweep cycle. Each sweep step is triggered by an external trigger signal (trigger source as described under "Extern Single"). The step width is set below at entry field "Step Lin" or "Step Log".
 If a different sweep mode was activated prior to the "Extern Step" mode, the current sweep is stopped. The "Extern Step" sweep always starts at the start frequency when triggered.
 The "Reset Sweep" button resets the sweep to the start frequency.

Example:

```
SOUR:SWE:FREQ:MODE STEP
SOUR:SWE:FREQ:SPAC LIN
SOUR:SWE:FREQ:STEP:LIN 1MHz
TRIG:FSW:SOUR EXT
SOUR:FREQ:MODE SWE (External trigger)
```

"Extern Start/ Stop"

Sets an automatically repeated sweep cycle that is started, stopped and restarted by subsequent external trigger events.

The first external trigger signal starts the sweep (Start).

The next external trigger signal stops the sweep at the current frequency (Stop).

The third external trigger signal starts the sweep at the start frequency (Start).

If a different sweep mode was activated prior to the "Extern Start/ Stop" mode, the current sweep is stopped and the "Extern Start/Stop" sweep starts at the start frequency when triggered.

The "Reset" button resets the sweep to the start frequency.

Refer to the description of the rear panel for information about the connectors for external trigger signal input.

The external trigger signal is input at the rear of the instrument (BNC connector TRIGGER).

Example:

```
SOUR:SWE:FREQ:MODE AUTO
TRIG:FSW:SOUR EAUT
SOUR:FREQ:MODE SWE (External trigger)
```

SCPI command:

```
[ :SOURce<hw> ] :SWEep [ :FREQuency ] :MODE on page 491
:TRIGger<hw>:FSWweep:SOURce on page 518
[ :SOURce<hw> ] :FREQuency:MODE on page 415
```

Execute Single Sweep - Frequency Sweep

Triggers the sweep manually. A manual sweep can only be triggered if "Mode Single" is selected.

SCPI command:

```
[ :SOURce<hw> ] :SWEep [ :FREQuency ] :EXECute on page 488
```

Reset Sweep - Frequency Sweep

Resets the sweep. The start frequency is set and the next sweep starts from there.

SCPI command:

```
[ :SOURce<hw> ] :SWEep:RESet [ :ALL ] on page 499
```

Start Freq - Frequency Sweep

Sets the start frequency.

SCPI command:

```
[ :SOURce<hw> ] :FREQuency:START on page 417
```

Stop Freq - Frequency Sweep

Sets the stop frequency.

SCPI command:

```
[ :SOURce<hw> ] :FREQuency:STOP on page 417
```

Center Freq - Frequency Sweep

Sets the center frequency.

SCPI command:

[\[:SOURce<hw>\]:FREQuency:CENTer](#) on page 413

Span - Frequency Sweep

Sets the span.

SCPI command:

[\[:SOURce<hw>\]:FREQuency:SPAN](#) on page 416

Current Freq - Frequency Sweep

Displays the current frequency.

If "Step" is set, the frequency for the next frequency step of the sweep is entered here.

SCPI command:

[\[:SOURce<hw>\]:FREQuency:MANual](#) on page 414

Spacing - Frequency Sweep

Selects linear or logarithmic sweep spacing.

- "Linear" With the linear sweep, the step width is a fixed frequency value which is added to the current frequency. The step width is entered below.
- "Logarithmic" With the logarithmic sweep, the step width is a constant fraction of the current frequency. This fraction is added to the current frequency. The logarithmic step width is entered below in %.
- "Ramp" With the ramp sweep, a synthesized continuous analog frequency sweep is provided for the set sweep time. The sweep time is entered below.

Note: The ramp sweep is only available with option R&S SMF-K4.

SCPI command:

[\[:SOURce<hw>\]:SWEep\[:FREQuency\]:SPACing](#) on page 492

Shape - RF Frequency Sweep

Selects the cycle mode for a sweep sequence (shape).

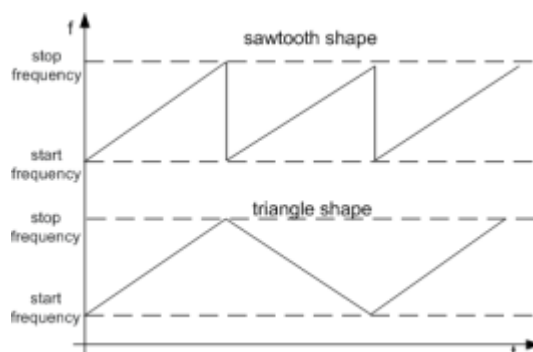

- "Sawtooth" One sweep runs from start to stop frequency. Each subsequent sweep starts at the start frequency, i.e. the shape of the sweep sequence resembles a sawtooth.

"Triangle" One sweep runs from start to stop frequency and back, i.e. the shape of the sweep resembles a triangle. Each subsequent sweep starts at the start frequency.

SCPI command:

[\[:SOURce<hw>\]:SWEep\[:FREQuency\]:SHAPE](#) on page 492

Step Lin/Log - Frequency Sweep

Sets the step width for the individual sweep steps. This entry is effective for all sweep modes.

"Step Lin" or "Step Log" is displayed depending on whether "Spacing Lin" or "Log" is selected.

"Step Lin" With the linear sweep, the step width is a fixed frequency value which is added to the current frequency. The linear step width is entered in Hz.

SCPI command:

[\[:SOURce<hw>\]:SWEep\[:FREQuency\]:STEP\[:LINear\]](#) on page 493

"Step Log" With the logarithmic sweep, the step width is a constant fraction of the current frequency. This fraction is added to the current frequency. The logarithmic step width is entered in %.

SCPI command:

[\[:SOURce<hw>\]:SWEep\[:FREQuency\]:STEP:LOGarithmic](#) on page 494

Count - RF Frequency Sweep

Sets the number of sweep steps.

SCPI command:

[\[:SOURce<hw>\]:SWEep\[:FREQuency\]:POINTs](#) on page 491

Sweep Time - RF Frequency Sweep

This feature is available for ramp spacing only.

Sets the sweep time for ramp sweeps. Ramp sweeps are selected above under "[Spacing - Frequency Sweep](#)" on page 133.

SCPI command:

[\[:SOURce<hw>\]:SWEep\[:FREQuency\]:TIME](#) on page 494

Dwell Time - Frequency Sweep

Sets the dwell time. The dwell time determines the duration of the individual sweep steps.

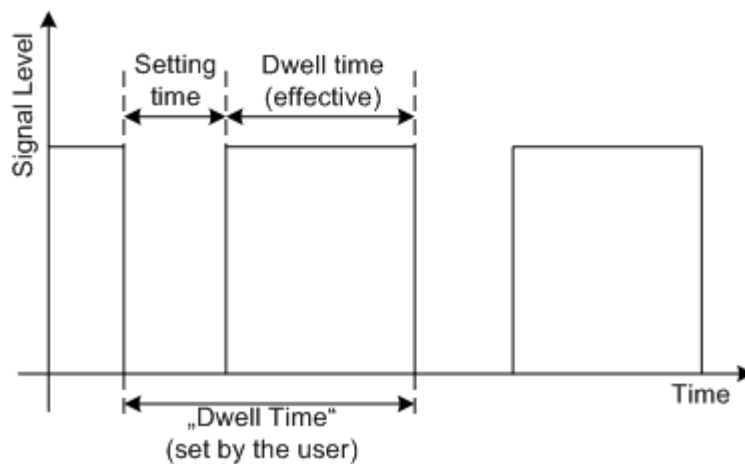

The "Dwell Time" set by the user is used as the step time of the sweep. The effective net dwell time is shorter, reduced by the setting time. This setting time may be greater than the time specified in the data sheet.

Note:

It is recommended to switch off the GUI update for optimum sweep performance especially with short dwell times (see [chapter 5.2.3.5, "Gui Update"](#), on page 96).

SCPI command:

[\[:SOURce<hw>\]:SWEep\[:FREQuency\]:DWELl](#) on page 488

Trigger Input Slope

Sets the polarity of the active slope of an applied instrument trigger.

This setting affects the TRIGGER input (BNC connector at the rear of the instrument or AUX connector).

"Positive" The rising edge of the trigger signal is active.

"Negative" The falling edge of the trigger signal is active.

SCPI command:

[\[:SOURce\]:INPut:TRIGger:SLOPe](#) on page 420

Edit Marker

Opens a dialog used for setting and editing the markers.

For a detailed description, see

- ["RF Frequency Marker"](#) on page 135
- [chapter 5.6, "LF Gen./Noise"](#), on page 235

SCPI command:

n.a.

RF Frequency Marker

The "RF Frequency Marker" dialog is called via the EDIT MARKER button in the "RF Frequency Sweep" dialog. Up to ten frequency markers can be defined. The level of the marker signal at the MARKER output changes according to the selected polarity when the frequency mark is reached. For each of these markers an amplitude marker can be activated in addition. If activated, the marker signal is attenuated by the set amplitude

when the frequency mark is reached. Only one marker is output at the MARKER output at one time.

RF Frequency Marker				
Marker				
Marker	Frequency		State	Amplitude Marker
1	1.000 500 000 000	GHz	<input type="checkbox"/> On	<input type="checkbox"/> On
2	1.000 500 000 000	GHz	<input type="checkbox"/> On	<input type="checkbox"/> On
3	1.000 500 000 000	GHz	<input type="checkbox"/> On	<input type="checkbox"/> On
4	1.000 500 000 000	GHz	<input type="checkbox"/> On	<input type="checkbox"/> On
5	1.000 500 000 000	GHz	<input type="checkbox"/> On	<input type="checkbox"/> On
6	1.000 500 000 000	GHz	<input type="checkbox"/> On	<input type="checkbox"/> On
7	1.000 500 000 000	GHz	<input type="checkbox"/> On	<input type="checkbox"/> On
8	1.000 500 000 000	GHz	<input type="checkbox"/> On	<input type="checkbox"/> On
9	1.000 500 000 000	GHz	<input type="checkbox"/> On	<input type="checkbox"/> On
10	1.000 500 000 000	GHz	<input type="checkbox"/> On	<input type="checkbox"/> On

Amplitude	1.0 dB
Marker Polarity	Invert
Active Marker	None

Marker - RF Frequency Marker

Displays the marker index. The active marker is selected by this index.

SCPI command:

n.a.

Frequency - RF Frequency Marker

Enters the frequency for the corresponding marker. If the marker is activated, the signal level at the MARKER output changes according to the set polarity on reaching the entered frequency.

SCPI command:

[\[:SOURce<hw>\]:SWEep\[:FREQuency\]:MARKer<ch>:FREQuency](#) on page 490

State - RF Frequency Marker

Switches on or off the selected marker. If on, the marker is output at the MARKER output on reaching the mark.

SCPI command:

[\[:SOURce<hw>\]:SWEep\[:FREQuency\]:MARKer<ch>:FState](#) on page 490

Amplitude Marker - RF Frequency Marker

Activates or deactivates the selected amplitude marker. If activated, the level is reduced by the amplitude entered under [Amplitude - RF Frequency Marker](#) on reaching the mark.

SCPI command:

[\[:SOURce<hw>\]:SWEep\[:FREQuency\]:MARKer<ch>:PState](#) on page 490

Amplitude - RF Frequency Marker

Sets the amplitude marker attenuation. This value is valid for all markers.

SCPI command:

`[:SOURce<hw>] :SWEep [:FREQuency] :MARKer:AMPLitude` on page 489

Marker Polarity

Selects the polarity of the **MARKER** output signal.

The user-programmable marker signal can be used for brightness control of an oscilloscope. The output becomes active when the sweep run has reached the marker. Up to 10 markers can be set to mark positions in the sweep run. The duration of the active signal is equal to the dwell time (DWEELL) of a step.

SCPI command:

`[:SOURce<hw>] :SWEep:MARKer:OUTPut:POLarity` on page 495

Active Marker - RF Frequency Marker

Selects the active marker. The active marker is output with a higher voltage than all other markers.

SCPI command:

`[:SOURce<hw>] :SWEep [:FREQuency] :MARKer:ACTive` on page 489

5.3.5 List Mode

Similar to a sweep, a series of previously defined frequency and level points is processed in List mode. In contrast to a sweep, however, a list with freely selectable value pairs (frequency and level) can be created. The value range for frequency and level covers the entire configurable value range of the instrument.



List mode and sweeps can not be activated simultaneously, they deactivate each other.

The lists can be created in the "List Editor". Each list is stored in its own file with the predefined file extension `*.lsw`. The name of the list file can be freely selected. The files are loaded from the "Lists..." file manager. Externally created tables with pairs of frequency and level values can be converted into List files using the import function. The external files must have the file extension `*.txt` or `*.csv`. These file formats are provided e.g. by the Microsoft®Excel program. The separators for table columns and for decimal floating-point numerals can be set. In addition, internally created List data can be exported into ASCII files using the export function.

The necessary hardware settings are calculated the first time a list is processed. With long dwell times, this calculation can be performed while the list is being processed; the entered dwell times are observed. With very short dwell times, calculation of the hardware settings increases the dwell time for the initial processing cycle; the entered value is only observed from the second processing cycle onwards. In this case a message appears to inform the user that there is a deviation between the current and set dwell times. No further calculations are required after the first run through a list. The current dwell times will definitely no longer deviate from the set dwell times.

The list is processed from the beginning to the end of the list (modes "Auto", ("External") "Single", ("External") "Step").

5.3.5.1 List Mode Dialog

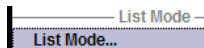

To open the "List Mode" menu, select "RF Frequency> Configure > List Mode" or use the MENU key under "RF Frequency".

The menu is used to activate/deactivate the operating mode List, to create, select and activate the lists, and to select the trigger mode and the dwell time.

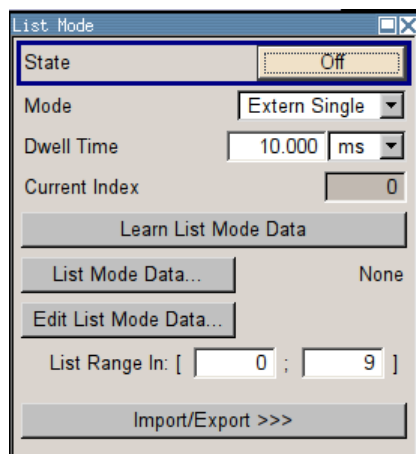

General Settings

State - List Mode

Activates/deactivates the List mode. The currently selected list is processed.

In case of a new or modified list, the necessary hardware settings are automatically determined on activation of the list mode. The data determined in this way is stored along with the list and is available whenever the list is used again.

This means that when activating the list mode, the system checks whether any hardware settings are present. If so, the list is started immediately, but if not they are automatically determined (the list is learnt).

A "Learn List Mode Data" button is available for deliberately activating list learning.

Note: Activating the list mode automatically deactivates all sweeps. During list mode the frequency and level indications do not display the currently set values.

SCPI command:

`[:SOURce<hw>] :FREQUENCY:MODE` on page 415

Mode - List Mode

Selects the cycle mode of the List mode.

"Auto" Cycle from the beginning to the end of the list with automatic restart at the beginning. If a different mode was activated prior to the Auto mode, the cycle continues from the beginning of the list. The duration of a list step is determined by the set dwell time.
Button "Reset" restarts the list at the starting point.

"Single" Single cycle from the beginning to the end of the list. If "Single" is selected, the cycle is not started immediately. The "Execute Single" button appears under the "Mode" line. The cycle is started with this button. The duration of a list step is determined by the set dwell time.
Button "Reset" restarts the list at the starting point.



"Step" Manual, step-by-step processing of the list. Activating "Step" stops the current list and the cursor moves to the value displayed for "Current Index". It is now possible to scroll up and down in the list in discrete steps by varying the index. The duration of a list step is determined by the time between two index entries.
Button "Reset" restarts the list at the starting point.



"Extern Single" Single cycle from the beginning to the end of the list as with "Single", but started by an external trigger.
The external trigger signal is input at the TRIGGER or AUX connector on the rear of the instrument.
Button "Reset" restarts the list at the starting point.

"Extern Step" Step-by-step cycle using the external trigger signal. Each trigger event starts a single step. The duration of a list step is determined by the time between two trigger events.
The external trigger signal is input at the TRIGGER or AUX connector on the rear of the instrument.
Button "Reset" restarts the list at the starting point.

SCPI command:

[\[:SOURce<hw>\]:LIST:MODE](#) on page 451

[\[:SOURce<hw>\]:LIST:TRIGger:SOURce](#) on page 454

Execute Single - List Mode

Triggers the list manually. This button is available only if mode "Single" is selected.

SCPI command:

[\[:SOURce<hw>\]:LIST:TRIGger:EXECute](#) on page 454

Reset - List Mode

Resets the list to the starting point.

SCPI command:

[\[:SOURce<hw>\]:LIST:RESet](#) on page 453

Dwell Time - List Mode

Enters the dwell time. The dwell time determines the duration of a list step in list operating modes "Auto", "Single" and "Extern Single". In these modes a complete list is processed either once or continuously.

In list operating modes "Step" and "Extern Step", the set dwell time does not affect signal generation. In this case, the duration of a list step is determined by the time between two (internal or external) trigger events.

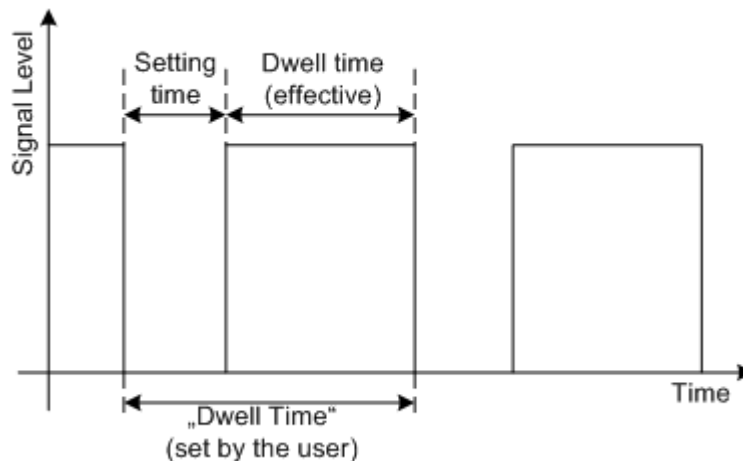

The "Dwell Time" set by the user is used as the step time of the list mode. The effective net dwell time is shorter, reduced by the setting time. This setting time may be greater than the time specified in the data sheet.

SCPI command:

[\[:SOURCE<hw>\]:LIST:DWELL](#) on page 448

Current Index - List Mode

Sets the list index in "Step" mode.

SCPI command:

[\[:SOURCE<hw>\]:LIST:INDEX](#) on page 450

Learn List Mode Data... - List Mode

Starts the determination of the hardware setting for the selected list. The data determined in this way is stored along with the list.

It may be necessary to deliberately activate list learning in the event of greatly altered environmental conditions that require new hardware settings.

If this is not done, a previously learned hardware setting will continue to be used when list mode is switched on ("State = On"). If no setting is available, e.g. when the list is used for the first time, learning is automatically activated.

SCPI command:

[\[:SOURCE<hw>\]:LIST:LEARN](#) on page 451

List Mode Data... - List Mode

Calls the "File Select" menu for selecting and creating a list or the "File Manager".



SCPI command:

[:SOURce<hw>] :LIST:SElect on page 453

[:SOURce<hw>] :LIST:DElete on page 443

[:SOURce<hw>] :LIST:DElete:ALL on page 444

Edit List Mode Data... - List Mode

Calls the editor for editing the selected list. A list consists of any number of frequency/level value pairs. The currently selected list is displayed.

	Frequency/Hz	Power/dBm
1	9 000.000	-145.00
2	19 000.000	-140.00
3	29 000.000	-135.00
4	39 000.000	-130.00
5	49 000.000	-125.00
6	59 000.000	-120.00
7	69 000.000	-115.00
8	79 000.000	-110.00
9	89 000.000	-105.00
10	99 000.000	-100.00
11		

"Frequency / Hz" Enter the frequency of the frequency/power value pair.

SCPI command:

[:SOURce<hw>] :LIST:FREQuency on page 449

"Power /dBm" Enter the level of the frequency/power value pair.

SCPI command:

[:SOURce<hw>] :LIST:POWer on page 452

"Goto" Selects row for editing.



If "Goto row" is selected, a window opens for entering the requested row.

"Edit" Calls a selection of possible actions described below.



"Insert Row" Inserts a new row before the marked row.

"Insert Range" Inserts new rows before the marked row. The number of rows to be inserted can be defined in an entry window.

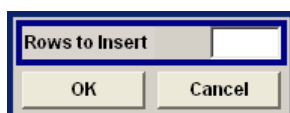

"Fill..." Opens a sub menu for defining a set of list values to be automatically entered in the List Mode table (see [chapter 5.3.5.2, "Filling the List Mode Data automatically"](#), on page 145).

"Delete Row" Deletes the marked row.

"Delete Range..." Allows to delete any number of rows starting with the marked row. The number of rows to be deleted can be defined in an entry window.

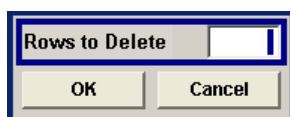

"Save as" Open the file menu to save the list under a new name. Each list is saved to the R&S Microwave Signal Generator Compact-Flash™ Card as a separate file with the file prefix *.lsw. The file name and the directory to which the file is saved are user-selectable.

"Save" The list is saved under its current name.

List Range In - List Mode

Defines an index range in the current list by setting the start and stop index. Only the values in the selected index range are processed in List mode, all other list entries are ignored.

SCPI command:

[\[:SOURce<hw>\]:LIST:INDEX:START](#) on page 450

[\[:SOURce<hw>\]:LIST:INDEX:STOP](#) on page 451

Trigger Input Slope

Sets the polarity of the active slope of an applied instrument trigger.

This setting affects the TRIGGER input (BNC connector at the rear of the instrument or AUX connector).

"Positive" The rising edge of the trigger signal is active.

"Negative" The falling edge of the trigger signal is active.

SCPI command:

[\[:SOURce\]:INPut:TRIGger:SLOPe](#) on page 420

Attenuator Settings

For instruments equipped with a step attenuator, setting of the parameters is provided in the "Attenuator Settings" section.

Mode – Attenuator Settings

Sets the attenuator mode at the RF output.

"Auto" The mechanical attenuator switches in steps of 10 dB at fixed points.

"Fixed" The attenuator is fixed at the current position.

SCPI command:

[:OUTPut<hw>:AMODE](#) on page 334

Attenuation – Attenuation Settings

Sets the attenuation. To enter a value in this field, the attenuator mode Fixed has to be selected. If Auto is selected, this field is read-only.

SCPI command:

[\[:SOURce\]:POWer:ATTenuation](#) on page 462

Fixed Range in (PEP): - Attenuation Settings

Displays the level range in which the level is set without interruption for the attenuator mode Fixed setting.

SCPI command:

[:OUTPut<hw>:AFIXed:RANGe:LOWer](#) on page 333

[:OUTPut<hw>:AFIXed:RANGe:UPPer](#) on page 333

RF OFF Mode - Attenuation Settings

Selects the mode of the mechanical attenuator, when the RF signal is switched off.

Note: This feature is only available when the instrument is equipped with one of the mechanical attenuator options, i.e. either option R&S SMF-B26 or R&S SMF-B27.

The setting of the RF OFF mode is not affected by an instrument preset (PRESET key), *RST and the "Save/Recall" function. This parameter is influenced only by the [Factory Preset](#).

"Normal" The current attenuation remains when the RF signal is switched off and thus provides fast and wear-free operation.

"Attenuated" The attenuation is set to maximum when the RF signal is switched off. This setting is recommended for applications that require a high level of noise suppression.

SCPI command:

[\[:SOURce<hw>\]:POWer:ATTenuation:RFOFF:MODE](#) on page 462

Import/Export

Lists can be imported from externally created files or exported into text or CSV-files. The import/export settings are available after clicking the "Import/Export" button.

Import/Export - List Mode

Expands the menu with the area for import and export of list mode files.

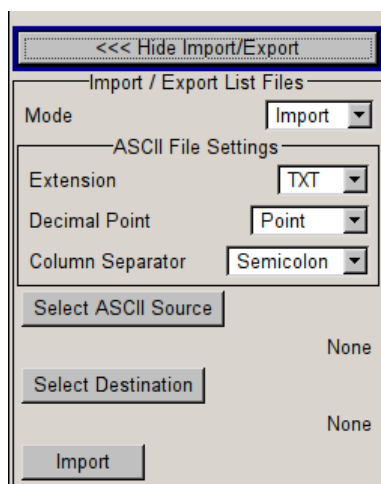

Externally edited Excel tables with frequency/level pairs can be imported as text or CSV-files and used for list mode.

On the other hand, internally created list mode lists can be exported as text or CSV-files.

Mode - List Mode

Selects if list mode lists should be imported or exported. The settings offered below depend on the selected mode.

SCPI command:

[\[:SOURce<hw>\]:LIST:DEXChange:MODE](#) on page 447

Extension - List Mode

Selects the file extension of the ASCII file to be imported or exported. Selection TXT (text file) or CSV (Excel file) is available.

SCPI command:

[\[:SOURce<hw>\]:LIST:DEXChange:AFILe:EXTension](#) on page 445

Decimal Point - List Mode

Selects the decimal separator used in the ASCII data between '.' (decimal point) and ',' (comma) with floating-point numerals.

SCPI command:

[\[:SOURce<hw>\]:LIST:DEXChange:AFILe:SEParator:DECimal](#) on page 446

Column Separator- List Mode

Selects the separator between the frequency and level column of the ASCII table.

SCPI command:

[\[:SOURce<hw>\]:LIST:DEXChange:AFILe:SEParator:COLumn](#) on page 446

Select ASCII Source / Destination - List Mode

Calls the "File Manager" for selecting the ASCII file to be imported into a list mode list (source) or the ASCII file the list mode list is exported (destination) in.

SCPI command:

[\[:SOURce<hw>\]:LIST:DEXChange:AFILe:SElect](#) on page 445

Select Destination / Source - List Mode

Calls the "File Manager" for selecting the list mode list to be exported (source) into an ASCII file or the destination for the ASCII file to be imported (destination) in.

SCPI command:

`[:SOURce<hw>] :LIST:DEXChange:SElect` on page 448

Import / Export - List Mode

Starts the export or import of the selected file.

When import is selected, the ASCII file is imported as list mode list.

When export is selected, the list mode list is exported into the selected ASCII file.

SCPI command:

`[:SOURce<hw>] :LIST:DEXChange:EXECute` on page 447

5.3.5.2 Filling the List Mode Data automatically

The "Fill List Mode Data" menu enables you to automatically set the values in the List Mode table.

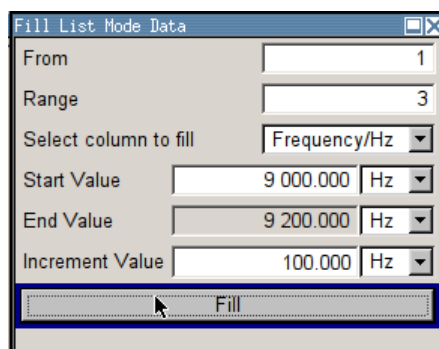

The start line and the number of rows to be filled are defined under "From" and "Range".

The column to be filled is selected under "Select column to fill". Depending on the selection here, the default for start, end, and increment value are set. As the settings are interdependent, a change of one parameter may result in the automatic change of one or more of the other parameters.

The filling of the column with the selected value settings is started with button "Fill".



The list entries are only computed when the "Fill" button is pressed.

From

Sets the start value of the index range.

SCPI command:

n.a.

Range

Sets the range for filling the table.

SCPI command:

n.a.

Select column to fill

Selects either the frequency or the level column to be filled with the value defined below.

SCPI command:

n.a.

Start value

Sets the start value for the frequency or the level entries.

SCPI command:

n.a.

End value

Sets the end value for the frequency or the level entries.

SCPI command:

n.a.

Increment value

Sets the increment for the frequency or the level entries.

SCPI command:

n.a.

Fill

Fills the selected column in the set range with values, starting with the start value and using the set increment.

SCPI command:

n.a.

5.3.6 Reference Oscillator

In the internal reference mode the internal reference signal is available at the REF OUT connector. The frequency of the internal reference signal is permanently set to 10 MHz.

The frequency of the internal reference oscillator can be influenced by applying a tuning voltage at the **EFC** (External Frequency Control) input at the rear of the instrument (**Frequency Adjustment**; see data sheet for technical information).



The settings of the reference oscillator are not influenced by an instrument preset ("PRESET" key).

5.3.6.1 Reference Oscillator Dialog

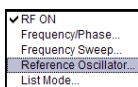

To open the "Reference Oscillator" dialog, select "RF Frequency > Configure > Reference Oscillator" or use the MENU key under "RF Frequency".

The menu is used to select the source, to enter the frequency of an external reference signal and to adjust the reference frequency.

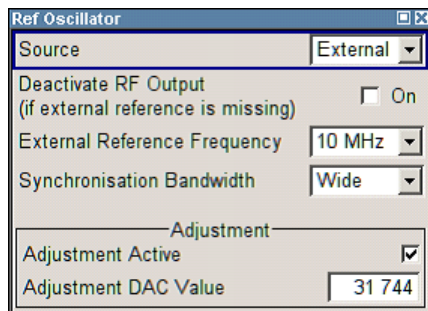

Source - Reference Oscillator

Selects the source of the reference frequency.

- "Internal" The internal reference signal of 10 MHz is used, comprising either the calibrated or a user-defined adjustment value.
- "External" An external reference signal is used. The frequency of the external reference signal must be selected under "External Reference Frequency".

SCPI command:

[\[:SOURce\]:ROSCillator:SOURce](#) on page 486

Deactivate RF Output - Reference Oscillator

Determines if the RF output is switched off in case of a missing external reference signal for selection external source.

If enabled, this setting ensures that no improper RF signal due to the missing external reference signal is output and used for measurements.

In addition to the error message "Ext Ref missing", the information "RF output deactivated" is indicated.

This setting is not influenced by a reset.

SCPI command:

[\[:SOURce\]:ROSCillator:EXTernal:RFOff:STATe](#) on page 484

External Reference Frequency

Selects the frequency of the external reference signal. An external reference signal in the range of 1 MHz to 20 MHz can be used.

SCPI command:

[\[:SOURce\]:ROSCillator:EXTernal:FREQuency](#) on page 484

Synchronization Bandwidth - RF Signal

(Source External only)

Selects the synchronization bandwidth for an external reference signal. The wideband setting is provided for using very good reference sources of high spectral purity.

"Narrow" Synchronization bandwidth is 1 Hz.

"Wide" Synchronization bandwidth is 750 Hz.

SCPI command:

[\[:SOURce\]:ROSCillator:EXTernal:SBANdwidth](#) on page 485

Output - Reference Oscillator

Selects the output for the reference oscillator signal. The external output is only available when the external reference frequency is 10 MHz.

SCPI command:

[\[:SOURce\]:ROSCillator:OUTPut:SOURce](#) on page 486

EFC - Reference Oscillator

Activates/deactivates the electronic frequency control. EFC is performed by applying a tuning voltage at the "EFC" input at the rear of the instrument (Frequency Adjustment; see data sheet for technical information).

SCPI command:

[\[:SOURce\]:ROSCillator:EFC:STATe](#) on page 484

Adjustment Active - Reference Oscillator

Selects adjustment mode.

"OFF" The calibrated adjustment value of the internal reference frequency is used. This value is determined at one of the R&S service shops during calibration.

"ON" A user-defined adjustment value is used. The value is entered under "Adjustment DAC Value". This allows the frequency to be impaired freely, for example to simulate a frequency error. The instrument is no longer in the calibrated state. However, the calibration value is not changed and the instrument resumes the calibrated state after switching the "Adjustment State" to Off.

SCPI command:

[\[:SOURce\]:ROSCillator\[:INTernal\]:ADJust\[:STATe\]](#) on page 486

Adjustment DAC Value

Enters a user-defined adjustment value for the internal reference frequency. This value is not used unless "Adjustment Active On" is selected.

SCPI command:

[\[:SOURce\]:ROSCillator\[:INTernal\]:ADJust:VALue](#) on page 485

5.4 RF Level/EMF

5.4.1 Overview of RF Level



Message "Level overrange/underrange"

If this message appears in the status line, the set level ("Level") is in the overrange (see data sheet).

The correct level setting and signal quality cannot be guaranteed if the set level is in the overrange/underrange.

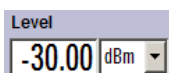

The value of the RF level is displayed in the level field in the header of the instrument's display and the easiest way to set the RF level is to set it directly in this field.

Be aware, that there is a difference between the RF level displayed in the header and the RF output level set in the "Level/EMF" dialog of the "RF" block.

5.4.1.1 RF level vs. RF output level

The level entered and displayed in the "Level" field takes the offset of any downstream attenuators/amplifiers into consideration by way of calculation. This means that with a level offset the level displayed in the header does not correspond to the level at the RF output, but rather to the level at the output of the downstream instrument.

This allows the desired level at the output of downstream instruments to be entered. The R&S Microwave Signal Generator changes the RF output level according to the set offset.

However, the level entered and displayed in the "Level" menu of the "RF" function block always corresponds to the RF output level. Any level offset is not taken into consideration.

The level offset is entered in the "Level" menu. Here it is also possible to set the level without taking the offset into consideration, and to make other settings, such as level offset, attenuator mode, power-on state.

The correlation is as follows:

"Level" (in header) = "RF output level" (Level in menu) + "Level offset" (Offset in menu)

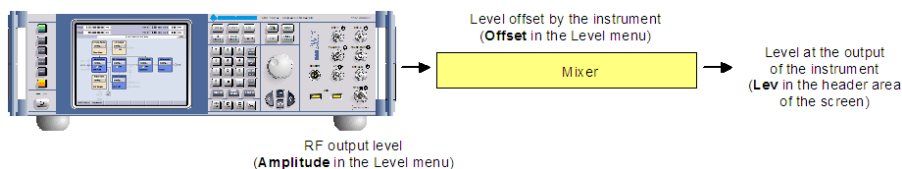

5.4.1.2 Setting the RF level

To change the RF level, press the LEVEL key and enter the desired level. Changes to the RF level have an immediate effect (without confirmation with the Enter key) on the output signal.

RF Level

Enters the RF level, considering the level offset (see [chapter 5.4.1.1, "RF level vs. RF output level"](#), on page 149).

dBm, dBuV, mV and uV can be used as the level units. The 4 unit keys are labeled with these units.

Note: The SCPI command sets the level of the "Level" display, i.e. an entered level offset is taken into consideration in the level value.

SCPI command:

`[:SOURce<hw>] :POWer [:LEVel] [:IMMediate] [:AMPLitude]` on page 463

5.4.2 RF Level

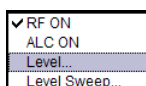

To open the "RF Level/EMF/ALC/UCOR" dialog, select "Level Control > Configure > Level" or use the MENU key under "Level Control".

The combined dialog "RF Level / EMF / ALC / UCOR" is divided into the several sections.

The top sections of this dialog provide access to the level settings.

The offset-free level, level offset, level limit and power resolution are set in the top section of the dialog.

The step width which is used when setting the level using the rotary knob (with "Variation Active On") is set in the "User Variation" section.

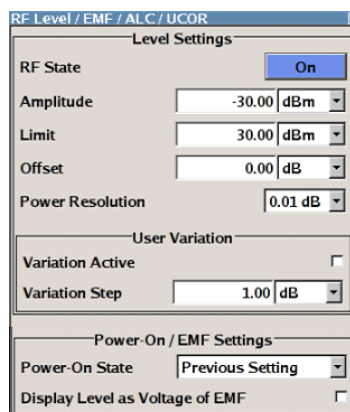

The power-on behavior of the instrument and the level display in the display header are set in the "Power-On / EMF Settings" section (see [chapter 5.4.3, "Power-On/EMF Settings"](#), on page 152).

5.4.2.1 Level Settings

The offset-free level, level offset, level limit and power resolution are set in the top section of the dialog.

RF Output State

Activated/deactivates the RF output by

- enabling/disabling the RF in the "Configure" dialog of the "RF" block.
- by enabling/disabling the RF State in the "RF Level/EMF/ALC/UCOR" dialog.

SCPI command:

`:OUTPut<hw>[:STATe]` on page 335

Amplitude - RF Level

Sets the RF level of the RF output connector.

The level entered and displayed here corresponds to the level at the RF output, i.e. any offset entry is not taken into consideration.

Note: The SCPI command `[:SOURce<hw>]:POWer[:LEVel][:IMMediate][:AMPLitude]` sets the level of the "Level" display, i.e. the level containing offset.

SCPI command:

`[:SOURce<hw>]:POWer:POWer` on page 466

Limit - RF Level

Sets the level limit.

The value specifies the upper limit of the level at the RF output connector. A message appears if an attempt is made to set a level above this limit and the level at the RF output is confined to the upper limit. However, the level indication is not influenced.

The value is not affected by an instrument preset (PRESET key), *RST and the "Save/Recall" function. This parameter is influenced only by the [Factory Preset](#) and its factory value is equal to the upper limit.

SCPI command:

`[:SOURce<hw>]:POWer:LIMit[:AMPLitude]` on page 464

Offset (Level) - RF Level

Sets the level offset relative to the RF level.

The level offset of a downstream instrument (e.g. an attenuator or amplifier) is entered.

The entry does not change the value of the RF level at the RF output. It only changes the RF level displayed in the display header. The value of the RF level in the header corresponds to the level at the output of the downstream instrument.

SCPI command:

`[:SOURce<hw>]:POWer[:LEVel][:IMMediate]:OFFSet` on page 463

Power Resolution - RF Level

Selects the resolution for the level settings.

Remote-control command: SOUR:POW:RES 0.01

SCPI command:

[\[:SOURce<hw>\]:POWer:RESolution](#) on page 467

5.4.2.2 User Variation

If the level is set using the rotary knob, the step width is defined in the "User Variation" section.

Variation Active - RF Level

Activates the user-defined step width used when varying the level value with the rotary knob.

"ON" The level value set with the rotary knob is varied using the user-defined step width which is entered under "Variation Step".

"OFF" The level value set with the rotary knob is varied in steps of one unit at the cursor position (standard operating mode).

SCPI command:

[\[:SOURce<hw>\]:POWer:STEP:MODE](#) on page 468

Variation Step - RF Level

Sets the user-defined step width for entering the RF level using the rotary knob. Level variation with this step width must also be activated with "Variation Active".

SCPI command:

[\[:SOURce<hw>\]:POWer:STEP\[:INCRement\]](#) on page 468

5.4.3 Power-On/EMF Settings

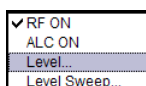

The power-on behavior of the R&S SMF and the level display in the display header are set in the "Power-On / EMF Settings" section of the "RF Level/EMF/ALC/UCOR" dialog.

To open the dialog, select "Level Control > Configure > Level" or use the MENU key under "Level Control".

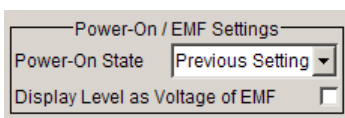

Power-On State - RF Signal

Selects the state which the RF output is to assume after the instrument is switched on.

"RF Off" The output is deactivated when the instrument is switched on.

"Previous Setting" When the instrument is switched on, the output assumes the same state as it had when the instrument was switched off.

SCPI command:

[:OUTPut<hw>\[:STATe\]:PON](#) on page 336

Display Level as Voltage of EMF - RF Level

Activates display of the signal level as voltage of the EMF (no-load voltage). If this setting is deactivated, the level is displayed as a voltage over a 50 Ohm load (preset state).

SCPI command:

n.a.

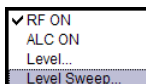
5.4.4 RF Level Sweep

To open the "Level Sweep" menu, select "Level Control > Configure > Level Sweep" or use the MENU key under "Level Control".

The "RF Level Sweep" dialog is used to activate and configure a sweep for the RF level. To open the dialog, select "Level Control > Configure > Level Sweep" or use the MENU key under "Level Control".

5.4.4.1 RF Level Sweep Settings

In the top section, the Level Sweep is activated and the sweep mode is selected. The buttons are used to reset the level sweep (all sweep modes) or to execute the level sweep ("Single" mode).

The sweep range, sweep spacing and dwell time are set in the bottom section.

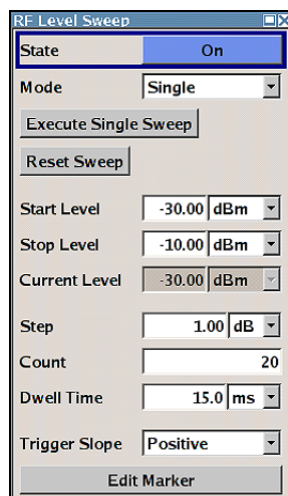
**State - Level Sweep**

Activates Level Sweep mode.

Note: Activating the RF level sweep mode automatically disables other sweep modes, and the list mode.

SCPI command:

[:SOURce<hw>] :POWer:MODE on page 466

Mode - Level Sweep

Selects the level sweep instrument operating mode and the sweep mode.

"Auto" Sets an automatically repeated sweep cycle. If a different sweep mode was activated prior to the "Auto" mode, the cycle continues from the current sweep setting.
The "Reset Sweep" button resets the sweep to the start level.

Example:

```
SOUR:SWE:POW:MODE AUTO
TRIG:PSW:SOUR AUTO
SOUR:POW:MODE SWE
```

"Single" Sets a single sweep cycle. The sweep is triggered by the "Execute Single Sweep" button.
If a different sweep mode was activated prior to the "Single" mode, the current sweep is stopped. The single sweep always starts at the start level.
The "Reset Sweep" button resets the sweep to the start level.

Example:

```
SOUR:SWE:POW:MODE AUTO
TRIG:PSW:SOUR SING
SOUR:POW:MODE SWE
SOUR:SWE:POW:EXEC
```

"Step" Sets a step-by-step sweep cycle.
If this mode is activated, the cursor moves to the value displayed for "Current Level". Each sweep step is triggered by a variation of the value in the "Current Level" entry window. The step width is set below at entry field "Step".
If this mode is activated, the cursor moves to the value displayed for "Current Level". If a different sweep mode was activated prior to the "Step" mode, the current sweep is stopped. The step sweep starts at the current level value.
The "Reset Sweep" button resets the sweep to the start level.

Example:

```
SOUR:SWE:POW:MODE MAN
SOUR:SWE:POW:STEP 0.5
SOUR:POW:MODE SWE
SOUR:POW:MAN -16
```

The value entered with command `SOUR:SWE:POW:STEP` sets the step width.

The value entered with command `SOUR:POW:MAN` has no effect, the command only triggers the next sweep step. However, the value has to be in the currently set sweep range (start to stop). In remote control only a step-by-step sweep from start to stop frequency is possible.

- "Extern Single" Sets a single sweep cycle. The sweep is triggered by an external trigger signal.
If a different sweep mode was activated prior to the "Extern Single" mode, the current sweep is stopped. The "Extern Single" sweep always starts at the start level.
Refer to the description of the rear panel for information about the connectors for external trigger signal input (see [chapter 2.2, "Rear Panel Tour"](#), on page 22).
The "Reset Sweep" button resets the sweep to the start level.

Example:

```
SOUR:SWE:POW:MODE AUTO
TRIG:PSW:SOUR EXT
SOUR:POW:MODE SWE (External trigger)
```

- "Extern Step" Sets a step-by-step sweep cycle. Each sweep step is triggered by an external trigger signal (trigger source as described under "Extern Single"). The step width corresponds to the step width of the rotary knob. If a different sweep mode was activated prior to the "Extern Step" mode, the current sweep is stopped. The "Extern Step" sweep always starts at the start level.
The "Reset Sweep" button resets the sweep to the start level.

Example:

```
SOUR:SWE:POW:MODE STEP
SOUR:SWE:POW:STEP 0.5
TRIG:PSW:SOUR EXT
SOUR:POW:MODE SWE (External trigger)
```

"Extern Start/ Stop" Sets an automatically repeated sweep cycle that is started, stopped and restarted by subsequent external trigger events.
 The first external trigger signal starts the sweep (Start).
 The next external trigger signal stops the sweep at the current frequency (Stop).
 The third external trigger signal starts the sweep at the start frequency (Start).
 If a different sweep mode was activated prior to the "Extern Start/ Stop" mode, the current sweep is stopped and the "Extern Start/Stop" sweep starts at the start frequency when triggered.
 The "Reset" button resets the sweep to the start level.
 The external trigger signal is input at the rear of the instrument (BNC connector TRIGGER).

Example:

```
SOUR:SWE:POW:MODE AUTO
TRIG:PSW:SOUR EAUT
SOUR:POW:MODE SWE (External trigger)
```

SCPI command:

[\[:SOURce<hw>\]:SWEep:POWer:MODE](#) on page 497
[:TRIGger<hw>:PSWEEP:SOURce](#) on page 520.
[\[:SOURce<hw>\]:POWer:MODE](#) on page 466

Reset Sweep - Level Sweep

Resets the sweep. The start level is set and the next sweep starts from there.

SCPI command:

[\[:SOURce<hw>\]:SWEep:RESet \[:ALL\]](#) on page 499

Execute Single Sweep - Level Sweep

Triggers the sweep manually. A manual sweep can only be triggered if "Mode Single" is selected.

Example:

```
SOUR:SWE:POW:MODE AUTO
TRIG:PSW:SOUR SING
SOUR:POW:MODE SWE
SOUR:SWE:EXEC
```

SCPI command:

[\[:SOURce<hw>\]:SWEep:POWer:EXECute](#) on page 496

Start Level - Level Sweep

Sets the start level.

SCPI command:

[\[:SOURce<hw>\]:POWer:START](#) on page 467

Stop Level - Level Sweep

Sets the stop level.

SCPI command:

`[:SOURce<hw>] :POWer:STOP` on page 468

Current Level - Level Sweep

Displays the current level.

If "Step" is set, the level for the next level step of the sweep is entered here.

SCPI command:

`[:SOURce<hw>] :POWer:MANual` on page 465

Shape - RF Level Sweep

Selects the cycle mode for a sweep sequence (shape).

"Sawtooth" One sweep runs from the start level to the stop level. The subsequent sweep starts at the start level again, i.e. the shape of sweep sequence resembles a sawtooth.

"Triangle" One sweep runs from start to stop level and back, i.e. the shape of the sweep resembles a triangle. Each subsequent sweep starts at the start level again.

SCPI command:

`[:SOURce<hw>] :SWEep:POWer:SHAPE` on page 498

Step - Level Sweep

Sets the step width for the individual sweep steps. This entry is effective for all sweep modes.

With the level sweep, the logarithmic step width is a constant fraction of the current level. This fraction is added to the current level. The logarithmic step width is entered in dB.

SCPI command:

`[:SOURce<hw>] :SWEep:POWer:STEP[:LOGarithmic]` on page 499

Count - RF Level Sweep

Sets the number of sweep steps.

SCPI command:

`[:SOURce<hw>] :SWEep:POWer:POINTs` on page 498

Dwell Time - Level Sweep

Enters the dwell time and determines the duration of the individual sweep steps.

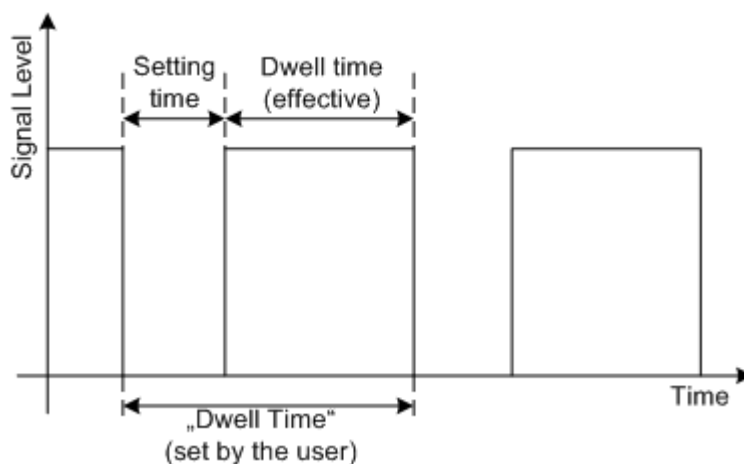

The "Dwell Time" set by the user is used as the step time of the sweep. The effective net dwell time is shorter, reduced by the setting time. This setting time may be greater than the time specified in the data sheet.

Note:

It is recommended to switch off the GUI update for optimum sweep performance especially with short dwell times (see [chapter 5.2.3.5, "Gui Update"](#), on page 96).

SCPI command:

[\[:SOURce<hw>\]:SWEep:POWer:DWELl](#) on page 495

Trigger Input Slope

Sets the polarity of the active slope of an applied instrument trigger.

This setting affects the TRIGGER input (BNC connector at the rear of the instrument or AUX connector).

"Positive" The rising edge of the trigger signal is active.

"Negative" The falling edge of the trigger signal is active.

SCPI command:

[\[:SOURce\]:INPut:TRIGger:SLOPe](#) on page 420

Edit Marker - RF Level Sweep

Opens the "RF Level Marker" menu. This menu is used for setting and editing the markers. For a detailed description, see [chapter 5.4.4.2, "RF Level Marker"](#), on page 158.

SCPI command:

n.a.

5.4.4.2 RF Level Marker

The "RF Level Marker" dialog is called via the EDIT MARKER button in the "Level Sweep" dialog.

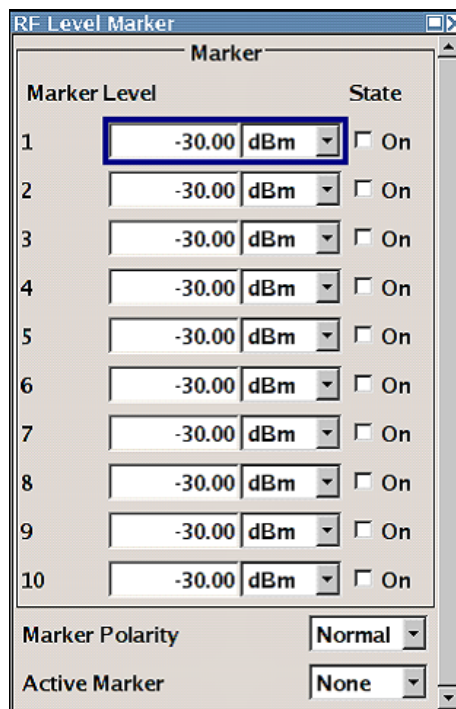

Marker - RF Level Marker

Displays the index of the marker.

SCPI command:

n.a.

Level - RF Level Marker

Enters the level for the corresponding marker. If the marker is activated, the signal level at the MARKER output changes according to the set polarity on reaching the entered level.

SCPI command:

[\[:SOURce<hw>\]:SWEep:POWer:MARKer<ch>:POWer](#) on page 497

State - RF Level Marker

Switches in or off the selected marker. If on, the marker is output at the MARKER output on reaching the mark.

SCPI command:

[\[:SOURce<hw>\]:SWEep:POWer:MARKer<ch>:STATe](#) on page 497

Marker Polarity

Selects the polarity of the **MARKER** output signal.

The user-programmable marker signal can be used for brightness control of an oscilloscope. The output becomes active when the sweep run has reached the marker. Up to 10 markers can be set to mark positions in the sweep run. The duration of the active signal is equal to the dwell time (DWELL) of a step.

SCPI command:

[\[:SOURce<hw>\]:SWEep:MARKer:OUTPut:POLarity](#) on page 495

Active Marker - RF Level Marker

Selects the active marker. The active marker is output with an higher voltage than all other markers.

SCPI command:

[\[:SOURce<hw>\]:SWEep:POWer:MARKer:ACTive](#) on page 496

5.4.5 Automatic Level Control - ALC

Your signal generator is equipped with an automatic level control unit to obtain best RF level accuracy.

Automatic Level Control (ALC) is an adaptive control system to stabilize the RF output level. It continuously monitors the current level and adjusts it to keep a steady state over temperature and time.



ALC is active in almost all applications by default. However, **Pulse Modulation** with very small pulse widths excludes ALC, as the control loop would detect incorrect values and result in level deviations.

Also note that ALC may detect incorrect values in **multi-transmitter** test setups. If multiple generators are coupled, reverse power may affect the ALC readings. Based on incorrect values, ALC would have an impact on the signal to intermodulation ratio.

ALC States

The following description basically explains the ALC states and their principle of operation. In particular **ALC OFF (Sample & Hold)** gives an overview on the function in terms of the equipment of the generator.

The R&S SMF offers the ALC states:

- On
- enables ALC permanently, regardless of the currently selected mode.
- Off
deactivates ALC.

The instrument switches to **Sample & Hold (S&H)** state, which still allows to maintain a constant output level.

The following section explains the functionality of "Sample & Hold", to provide an overview and to indicate what is to be considered. "On" and "Auto" require no additional explanation. Furthermore, find the ALC state settings described in detail in [State - ALC](#).

ALC OFF (Sample & Hold)

In "S&H" mode, the signal generator switches for a short period of time into CW mode and activates ALC. ALC adjusts the level to the set value and the generator holds the value (freeze). Then, the generator switches ALC off again and back to the operating mode.

RF output behaviour during Sample & Hold depends on the configuration of your instrument. Instruments equipped with...:

- a mechanical step attenuator**
 By default, the mechanical step attenuator is not switched during S&H cycles to optimize the settling time. The instrument provides the output power for 3 ... 5 ms. However, you can affect the attenuation at the output by the setting "RF during Power Search" to "Minimum", see [RF During Power Search - ALC](#). Then the generator decreases the level by 30 dB with the mechanical attenuator. Note that this may take a certain period of time.
 The **mechanical step attenuator** is switched off. However, you can affect the attenuation at the output by the setting "RF during Power Search" to "Minimum", see [RF During Power Search - ALC](#). Then, the generator adjusts the level with the mechanical attenuator, as described above. Note that mechanical attenuators take a certain period of time.
- no step attenuator**
 The signal generator outputs the set level for 3 to 5 ms after level or frequency setting during a Sample & hold measurement.
 Instruments equipped with one of the options R&S SMF-B26 or R&S SMF-B27 come without step attenuator.

The level control status is permanently displayed as a status message in the info line.

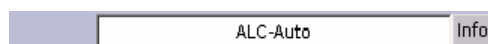

5.4.5.1 Automatic Level Control Settings

To open the "Automatic Level Control" dialog, select "Level Control > Configure > Automatic Level Control" or use the MENU key under "Level Control".

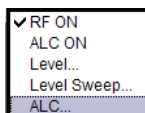

The combined dialog "RF Level / EMF / ALC / UCOR" is divided into the several sections and provides access to the "ALC" settings and to function "User Correction", see [chapter 5.4.7, "User Correction"](#), on page 208).



External level control via the EXT ALC input is offered in addition to internal ALC (see [chapter 5.4.5.2, "External Level Control"](#), on page 162).

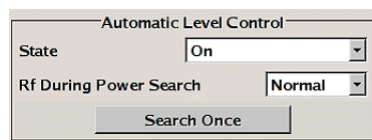

State - ALC

Activates/deactivates internal level control.

"On"

Activates ALC, regardless of the operating conditions.

If "Attenuator Mode Fixed" is selected in addition, the instrument adjusts the level of every level and frequency setting.

This provides the highest level accuracy.

"Off (Sample & Hold)" Deactivates internal level control. Sample & hold closes the level control loop at every frequency and level change for a short period of time. The level control voltage is sampled and then clamped.

SCPI command:

`[:SOURce<hw>] :POWer:ALC [:STATe]` on page 462

RF During Power Search - ALC

Activates the mode for the mechanical step attenuator and for output during ALC power search.

"Normal" The RF output is active during power search.

"Minimum" The RF output is inactive during power search.

SCPI command:

`:OUTPut<hw>:ALC:SEARch:MODE` on page 334

Search Once - ALC

Forces the generator to execute level adjustment once, although the "Sample & Hold" mode is active.

SCPI command:

`[:SOURce<hw>] :POWer:ALC:SONCe` on page 461

5.4.5.2 External Level Control

With external level control, the level control is performed using an external DC signal applied at the EXT ALC input. The signal can be provided either by a diode detector or a power meter. A reference voltage has to be entered for the desired level at the RF output of the generator.

The "External Level Control" dialog is part of the **Level...** dialog and is opened in the LEVEL CONTROL function block or using the "MENU" key under "Level Control".

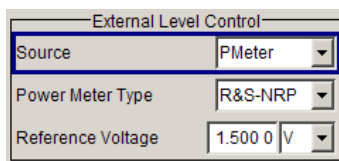

External Level Control	
Source	PMeter
Power Meter Type	R&S-NRP
Reference Voltage	1.500 0 V

Source - External Level Control

Selects the source for level control.

"Internal" The internal detector is used. The settings under ALC are valid (see [chapter 5.4.5, "Automatic Level Control - ALC"](#), on page 160).

"Diode" A diode detector is connected to the EXT ALC input. The RF level is controlled by the external voltage provided by the detector. The reference voltage for the desired level at the RF output of the generator has to be entered below. See the specification of the detector for details.

"PMeter" A power meter can be connected to the EXT ALC input. The RF level is controlled by the external voltage provided by the power meter. The reference voltage for the desired level at the RF output of the generator has to be entered below. Please see the specification of the power meter for details.

SCPI command:

[:SOURce<hw>] :POWer:ALC:SOURce on page 461

Power Meter Type - External Level Control

Selects the power meter that is used for external level control. This feature is only available if PMeter is selected in the Source field.

SCPI command:

[:SOURce<hw>] :POWer:ALC:PMETer:TYPE on page 460

Reference Voltage - External Level Control

Sets the reference voltage for the desired level at the RF output of the generator. See the specification of the external source (diode detector or power meter) for details.

SCPI command:

[:SOURce<hw>] :POWer:ALC:REFerence on page 461

5.4.6 Power Sensors

The R&S signal generator supports R&S NRP-Z power sensors to measure the power of the output signal in the RF path or any freely selectable source. The generator performs up to four power measurements, with the sensors either directly connected, or via the R&S NRP-Z5 USB Sensor Hub.



The R&S NRP-Z5 USB Sensor Hub (high-speed USB 2.0) can host up to 4 R&S NRP-Z sensors and provides simultaneous internal and external triggering of all connected sensors. You can directly connect the R&S NRP-Z Sensors to the standard NRP sensor connectors of the hub. The hub is connected to the R&S instrument either with the R&S NRP-Z2 extension cable, or via USB using with the adapter cable R&S NRP-Z4. See also the R&S website <http://www.rohde-schwarz.com> in section "Power Meters & Voltmeters > R&S NRP-Z Sensors" for information on the sensor hub and the available accessories.

To connect an R&S NRP-Z sensor directly, the R&S SMF provides the SENSOR connector. A sensor connected there is always assigned as Sensor 1. Alternatively, you can connect a sensor at a USB interface, using one of the USB adapters R&S NRP-Z3 or R&S NRP-Z4.

The instrument automatically detects a connected R&S NRP-Z power sensor and indicates it in the [NRP-Z Power Viewer](#) dialog. In addition, you find device specific information on the connected sensor in [chapter 5.2.3.6, "NRP-Z Info/Update"](#), on page 97. For information on the scope of your power sensor refer to the manual of your R&S NRP-Zxx power sensor.

5.4.6.1 NRP-Z Power Viewer

A sensor continuously measures the average signal power of the selected source. The signal generator shows the result in either the "NRP-Z Power Viewer" dialog, or directly in the block diagram. You can activate the permanent display in the block diagram in the "NRP-Z Power Viewer" dialog. This dialog provides access to all parameters concerning sensor settings, like average or peak display, reference source, filter and level offset, see [NRP-Z Power Viewer Settings](#).

The signal generator also supports the use of R&S NRP-Z power sensors for the acquisition of level correction data. The acquired level correction data is used to create and activate lists in which level correction values predefined by the user are freely assigned to RF frequencies. Correction is performed by the user-defined table values being added to the output level for the respective RF frequency (see [chapter 5.4.7, "User Correction"](#), on page 208).

In addition, it enables sweep measurements on DUTs (see [chapter 5.4.6.2, "NRP-Z Power Analysis"](#), on page 169). Pulse data analysis is possible with power sensor R&S NRP-Z81.

NRP-Z Power Viewer Settings

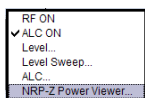

To open the "NRP-Z Power Viewer" dialog, select "Level Control > Configure > NRP-Z Power Viewer" or use the MENU key under "Level Control".

"Sensor 1" is firmly assigned to the sensor on the circled SENSOR socket. If no sensor is connected to this socket, channel 1 remains not assigned. Sensors 2...4 are assigned to the sensors at the USB connectors, according to their sequence of connection.



When you connect your power sensor(s) via the R&S NRP-Z5 USB sensor hub, each channel of the hub is firmly assigned to the associated sensor channel in the generator.

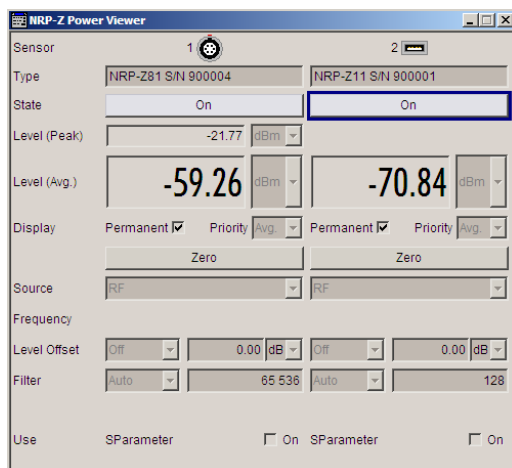

Sensor - Power Viewer

Indicates the connector used for the detected sensors. The values listed below belong to the respective sensor.

In remote control, the sensors are set up using the `SENSe` commands. The remote measurement is triggered by the `READ` query which also provides the measurement results. The sensor is selected by suffix 1, 2, 3 or 4 in key word `SENSe` or `READ` of the command header.

Suffix 1 denotes the sensor connected to `SENSOR`, suffix 2 the one at the first USB interface, and suffix 3 and 4 are assigned to the sensors at the following USB interfaces. The suffix is identical to the index which is assigned automatically to each sensor upon connection.

In order to detect all connected sensors the state of all four connectors (i.e. `SENsor1/SENsor2/SENsor3/SENsor4`) must be checked.

Note: The software version of the connected power sensor can be retrieved by means of the remote control command `:SENS:POW:TYPE?`.

Use the "Setup >" [chapter 5.2.3.6, "NRP-Z Info/Update"](#), on page 97 dialog to update the sensor software.

SCPI command:

`SENSe<ch>[:POWer]:STATus[:DEVICE]` on page 350

Type - Power Sensors

Indicates the type and the serial number of the connected R&S NRP-Z power sensor. The sensor type is automatically detected.

SCPI command:

`SENSe<ch>[:POWer]:TYPE` on page 381

`SENSe<ch>[:POWer]:SNUMber` on page 349

State - Power Sensors

Activates/deactivates level measurement by the power sensor.

The local state is set with the `INIT` command. Switching the local state off enhances the measurement performance.

In remote control, the sensors are set up using the `SENSe` commands. The remote measurement is triggered by the `READ` query which also provides the measurement results. The state is not influenced by these commands, measurements results can be retrieved with local State on or off.

The sensor is selected by suffix 1, 2, 3 or 4 in key word `SENSe` or `READ` of the command header.

Suffix 1 denotes the sensor connected to `SENSOR`, suffix 2 the one at the first USB interface, and suffix 3 and 4 are assigned to the sensors at the following USB interfaces. The suffix is identical to the index which is assigned automatically to each sensor upon connection.

In order to detect all connected sensors the state of all four connectors (i.e. `SENsor1/SENsor2/SENsor3/SENsor4`) must be checked.

To query the availability of a sensor at a given connector, use the command

`SENSe<ch>[:POWer]:STATus[:DEVICE]` on page 350.

SCPI command:

`:INITiate<ch>[:POWer]:CONTInuous` on page 342

Level (Peak) - Power Sensors

With certain power sensors only, e.g. R&S NRP-Z81.

Indicates the measured peak level value with the selected unit.

SCPI command:

`:READ<ch>[:POWer]` on page 342

Level (Avg.) - Power Sensors

Indicates the measured level value with the selected unit.

SCPI command:

`:READ<ch>[:POWer]` on page 342

Unit - Power Sensors

Selects the unit used for result display.

The power sensor provides the measured value in Watt.

In which unit the measured value is indicated is selected here and might be Watt, dBm or dBuV.

SCPI command:

`SENSe<ch>:UNIT[:POWer]` on page 382

Permanent Display State - Power Sensors

Activates the permanent indication of the power measurement result in the upper right corner of the block diagram. The instrument shows the type of sensor, the corresponding connector, the measurement source and - if set - the offset.

2	NRP-Z11 Offs	-83.10dBm	RF
3	NRP-Z81	-59.39dBm	User

It is possible to switch the permanent display active for several sensors. The instrument indicates the values of a maximum of two sensors simultaneously, in ascending order of connected channels. If you activate the display of a third sensor, the instrument fades out the values of the last highest channel number automatically.

SCPI command:

`SENSe<ch>[:POWer]:DISPlay:PERManent:STATe` on page 346

Display Priority - Power Sensors

Selects whether the average or the peak power measurement result is indicated when permanent display is active.

SCPI command:

`SENSe<ch>[:POWer]:DISPlay:PERManent:PRIority` on page 345

Zero - Power Sensors

Activates the auto zero function.

Zeroing calibrates the external power sensor by adjusting its reading at zero signal power. For this purpose, the RF power source must be switched off or disconnected from the sensor (see tips below). R&S power sensors automatically detect the presence of any significant input power. This aborts zeroing and generates an error message. Zeroing can take a few seconds, depending on the sensor model; refer to the documentation of your external power sensor for more information.

Tips for zeroing

Zeroing should be performed:

- During warm-up after switching on or connecting the instrument
- After a substantial change of the ambient temperature
- After fastening the power sensor module to an RF connector at high temperature
- After several hours of operation
- When very low-power signals are to be measured, e.g. less than 10 dB above the lower measurement limit.
- Switch off the RF power source for zeroing; do not disconnect it from the power sensor. In this way you will maintain the thermal equilibrium, and zeroing will also compensate for the noise superimposed on the measured signal (e.g. from a broadband amplifier).

SCPI command:

[SENSe<ch>\[:POWER\]:ZERO](#) on page 381

Source - Power Sensors

Selects the source for measurement.

"RF"	Measurement source is the RF signal of the generator. The RF frequency is used as the measurement frequency of the sensor and the corresponding correction factor is used. In this mode the RF frequency of the generator is send to the sensor automatically if changed.
"User"	Measurements source is any freely selectable source. The frequency is entered manually under frequency (e.g. for measurement of amplifier gain with 2 sensors).

SCPI command:

[SENSe<ch>\[:POWER\]:SOURCE](#) on page 349

Frequency - Power Sensors

Source User only

Enters the frequency for measurement source "User".

SCPI command:

[SENSe<ch>\[:POWER\]:FREQUENCY](#) on page 348

Level Offset - Power Sensors

Activates and defines a level offset which is added to the measured value. This allows e.g. an attenuator in the signal path to be taken into account. The offset is always entered in dB, irrespective of the selected unit for result display.

SCPI command:

[SENSe<ch>\[:POWER\]:OFFSET:STATE](#) on page 349

[SENSe<ch>\[:POWER\]:OFFSET](#) on page 349

Auto Once

Searches for the optimum filter length for the current measurement conditions and indicates value in the "Filter Length" field above.

SCPI command:

`SENSe<ch>[:POWer]:FILTer:SONCe` on page 347

Filter Length - Power Sensors

Selects the filter length used for measurement. The filter length is the multiplier for the measurement time and thus directly influences it.

The averaging filter is used to reduce fluctuations in the measured result to the extent desired. Such fluctuations can be caused by inherent noise of the measuring instrument, modulation of the measurement signal or beats from the superposition of adjacent carriers. A more stable display has to be traded off against longer measurements. The measurement result is obtained from a two-stage averaging process.

Note: Longer measurements does not mean that it takes longer to display a new result, but rather that it takes longer for the result to settle when the power changes.

Measurements are continuously repeated in a predefined time window. The measurement result is obtained by averaging the measured values for the last 2N time windows. The number N is the filter length, the factor of 2 arises because the output signals from the microwave detector to suppress low-frequency noise are chopped at the same rate as the time windows, which means that an independent measured value can only be obtained from two consecutive values. As the filter length is the multiplier for the time window it directly influences the measurement time.

The filter length can be selected automatically or can be manually set to a fixed value. As a preliminary, you should always check if the auto mode is giving satisfactory results because you will always have to adjust an optimal, manual filter-length setting if the power is not constant.

Selection "Fixed Noise" is offered for reaching defined measurement accuracy.

"Auto" The filter length is automatically selected and adapted to the currently measured value. With very high signals the filter length and therefore the measurement time can be short. With very low signal levels the filter length and therefore the measurement time is increased in order to reduce noise. The used filter length is indicated in the field to the right.

"User" The filter length is set manually.
The filter length is entered in the entry window to the right. As the filter length works as a multiplier for the time window, this results in a constant measurement time. Values 1 and 2^n are settable.

Note: The time window varies depending on the used sensor. For most sensors it is fixed to 20 ms. For the R&S NRP-Z81 sensor it is 10 us. Therefore, the user filter length for the R&S NRP-Z81 has be about 1000 times larger than the filter length for other sensors in order to achieve the same filtering result.

The "Auto Once" button can be used to search for the optimum filter length for the current measurement conditions. The found filter length is indicated in the field to the right.

"Fixed Noise" The averaging factor is selected so that the sensor's intrinsic noise (2 standard deviations) does not exceed the specified noise content. The desired noise content is entered in the entry field to the right. To avoid very long settling times when the power is low, the averaging factor can be limited with the "Timeout" parameter.

SCPI command:

`SENSe<ch>[:POWER]:FILTer:TYPE` on page 348

`SENSe<ch>[:POWER]:FILTer:LENGTh:AUTO` on page 346

`SENSe<ch>[:POWER]:FILTer:LENGTh[:USER]` on page 346

`SENSe<ch>[:POWER]:FILTer:NSRatio` on page 347

`SENSe<ch>[:POWER]:FILTer:NSRatio:MTIME` on page 347

Use SParameter - Power Sensors

Activates the use of the S-Parameters correction data of the connected power sensor. For sensor with attenuator this checkbox is automatically checked.

Refer to the manual of the connected R&S NRP-Zxx power sensor for a description on how to use the s-parameters table.

SCPI command:

`SENSe<ch>[:POWER]:CORRection:SPDevice:STATE` on page 345

Use Sensor for RF Lev. Control - Power Sensors

Enables/disables controlling of the RF level via the power sensor.

SCPI command:

n.a.

5.4.6.2 NRP-Z Power Analysis

The signal generator in combination with a connected R&S NRP probe allows sweep measurements on DUTs.

To open the "NRP-Z Analysis" dialog, select "Level Control > NRP-Z Power Analysis" or use the menu key under "Level Control".

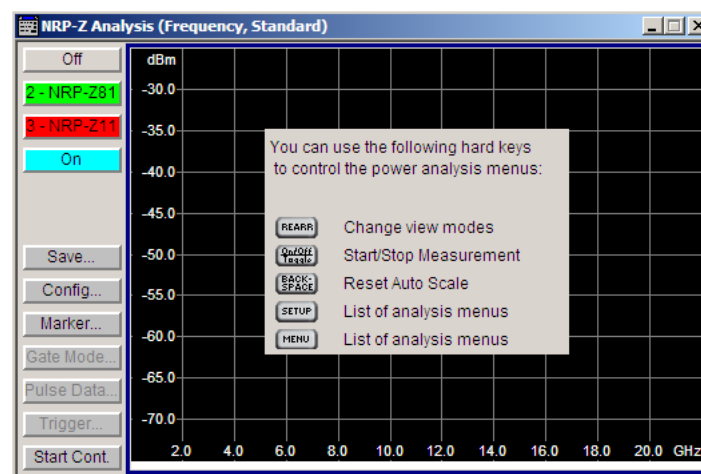

The measurement data of the sensors is displayed in traces in a measurement diagram. Four traces are available. The traces are automatically or manually assigned to the sensors. In addition to the data traces, a reference trace can be stored and recalled and/or the trace indication can be frozen temporarily (hold trace), thus enabling comparison of traces. Readout and comparison of particular values of the traces is possible by means of four markers.

Three measurement modes are offered:

- power versus frequency (frequency response)
- power versus power (power sweep, AM/AM)
These two modes are generator driven, i.e., the generator provides the measurement signal.
- power versus time (power measurement in the time domain R&S NRP trace mode).
This mode is signal driven, i.e. besides the generator signal also external signals can be analyzed. Time mode requires an additional trigger event, for which level, hysteresis and dropout time are freely selectable. The generator also features pulse data analysis in this mode, provided that R&S power sensor NRP-Z81 is connected.

The timing can be used for normal and fast measurements in all modes.

By the use of a separate frequency than the set generator frequency, measurement results retrieved at a different frequency can be displayed in the diagram (e.g. as provided at the output of the DUT).

Special functions of some hardkeys

The instrument provides hardkeys with special functions for convenient operation, when the "NRP-Z Power Analysis" dialogs are active.



The REARR key toggles between different views of the diagram, selectable in the "REARR list NRP-Z Analysis dialog", see ["REARR list - Power Analysis"](#) on page 184:

- standard, diagram and buttons are displayed,
- full display, diagram with marker list but no buttons are displayed,
- full display, diagram with pulse data list but no buttons are displayed, and
- full display only diagram is displayed.



The MENU and SETUP keys directly open a special power analysis menu. Either the complete menu tree or the setup menu tree is available in addition to the power analysis menu.

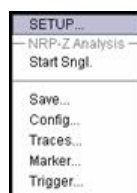

The instrument also provides this context-sensitive menu by pressing the right mouse button in the measurement diagram.



The ON /OFF key toggles between measurement start and stop.



The BACKSPACE key resets the scaling of the y-axis to suitable values after the use of auto scaling in the expanding mode. In this mode, the y scale might get too expanded due to temporary high power values. The reset function resets the diagram again, to also indicate smaller power values.

If "Auto Scale" is turned off, press the BACKSPACE button to switch to Auto Scale expanding mode, and to reset "Auto Scale".

Example Test Setup

As a power meter has no built-in selection, it is measuring all signal components from nearly DC to 40 GHz and higher. Therefore, the DUT's signal must be rather pure or subjected to external filtering (harmonics, spurious) before measured.

The test setup for the power analysis in the **power versus frequency or power versus power** is as follows:

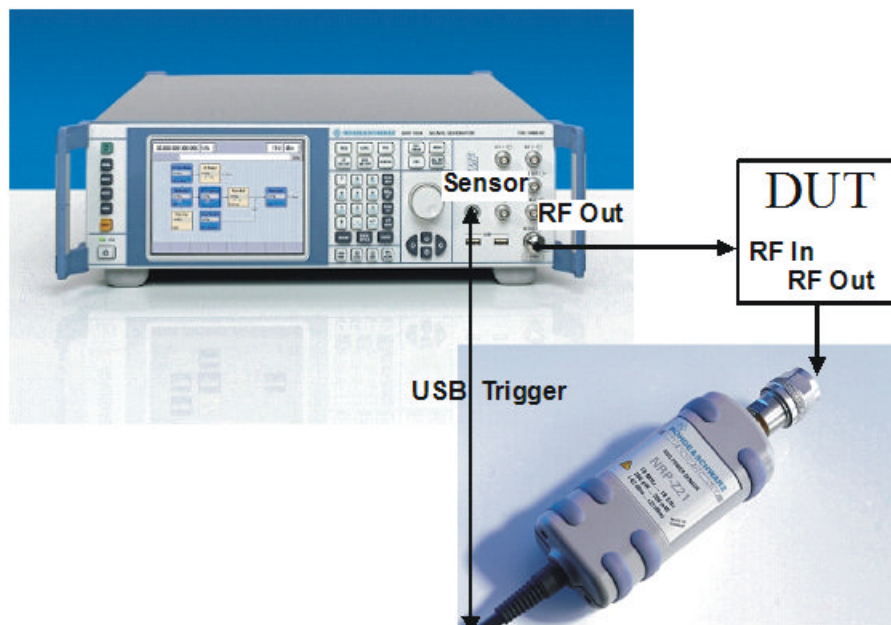

1. Connect the DUT (e.g. bandpass) to the RF output of the instrument and the RF input of the R&S NRP-Zxx sensor (e.g. R&S NRP-Z21).
2. Connect the USB output of the R&S NRP-Zxx to the SENSOR connector of the instrument.
3. Open the "NRP-Z Analysis" diagram in the "Level Control" block of the generator
4. Setup the measurement and scale diagram in the "Configure..." dialog (e.g. fast measurement, 200 measurement points, range, x-axis and y-axis scale).
5. Trigger measurement by pressing the "Start" button in the "NRP-Z Power Analysis" diagram.
6. If required, perform the further settings:

- a) Set markers by means of the rotary knob. To access the markers activate the "NRP-Z Analysis Frequency / Marker" diagram view with the REARR key. The markers are moved by means of the cursor and the roll key to the desired trace position.

Note: The "NRP-Z Analysis Frequency / Marker" view is activated in the "REARR list NRP-Z Analysis" dialog (see "REARR list - Power Analysis" on page 184). Press the REARR key repeatedly until you have this view.

- b) Store a hardcopy of the measurement results "Configure Diagram" on page 183 ("Save..." submenu).
- c) Apply user correction. "Ucor" is also available for NRP-Z measurements (see chapter 5.4.7, "User Correction", on page 208).

The diagrams below show the result of the above settings, an RF frequency range of 1-6 GHz and the level range of -65 dB to 5 dB.

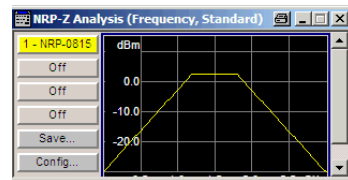

Fig. 5-1: Standard view, diagram and buttons are displayed

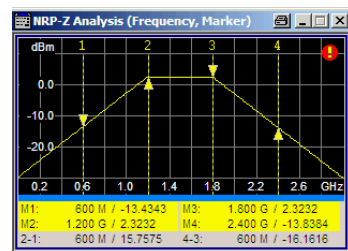

Fig. 5-2: Full screen "Marker View", diagram with marker and marker list are displayed

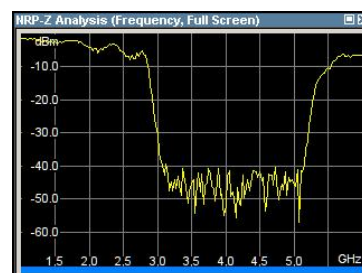
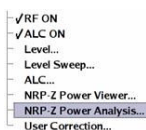

Fig. 5-3: Fullscreen view, only the diagram is displayed

Measurement Diagram

To open the "NRP-Z Power Analysis" diagram, select "Level Control > Configure > NRP-Z Power Analysis" or use the MENU key under "Level Control".



The dialog comprises the measurement diagram with start button and provides access to the dialogs for setting up the measurement and sensor parameters, for configuring the diagram and trace indication, and for storing hardcopies of the measurement results.

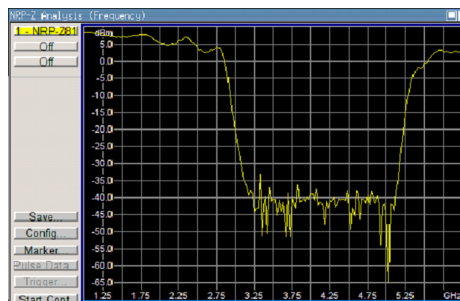

The R&S signal generator supports various graph views, according to the methods of measurement and also additional functions such as the use of markers.

Note: Activate the relevant diagram views in the "REARR list NRP-Z Analysis" dialog, see ["REARR list - Power Analysis"](#) on page 184, and switch to the currently needed view with the aid of the REARR key or STR+<A>.

Markers and the marker list are available in the "NRP-Z Analysis Frequency / Marker" view which is shown in the graph above (see also ["Define Markers"](#) on page 202). Select a marker with the roll key. One click activates the cursor, the second click captures the selected marker to move it to the desired position. Set the focus back to the diagram with a double click on ESC.

The list below the diagram displays the numerical readout of the marker values.

The x-axis of the measurement diagram is freely scalable in the frequency or power range of the generator, the power range for the y-axis is +100 dBm to -200 dBm. In power versus frequency mode, the frequency range of the x-axis is separately scalable. The available time range for power versus time measurements is -1s to +2s.

It is possible to select single or continuous measurement mode in the "Config..." menu. Single starts a single measurement after the trigger, continuous causes a restart of the measurement after each pass. The measurement is triggered by pushing the "Start" button. In continuous mode, the "Start" button is replaced by a "Stop" button after the trigger which can be used to cancel the measurement. A progress bar indicates the current status of the measurement.

In time mode additional triggering is required which is configured in the trigger dialog.

Changing to trace source **Hold** freezes the current trace indication in the diagram.

Some front panel keys are assigned special functions if the power analysis is active (see overview of features and operation in section [chapter 5.4.6.2, "NRP-Z Power Analysis"](#), on page 169):

Marker and Pulse Data Indication - Power Analysis

The marker and pulse data value indication below the measurement diagram is only available for certain views of the diagram. The REARR key or the key combination <STR +A> toggles between the different diagram views (see [chapter 5.4.6.2, "NRP-Z Power Analysis"](#), on page 169). The marker indication in the measurement diagram is activated in the marker dialog, see ["Define Markers"](#) on page 202.

Tip: In remote-control mode, include the markers of the diagram, their values or the pulse data in the hardcopy file.

SCPI command:

`:TRACe[:POWER]:SWEep:MEASurement:MARKer:DISPlay:ANNotation[:STATe]` on page 386

`:TRACe[:POWER]:SWEep:MEASurement:PULSe:DISPlay:ANNotation[:STATe]` on page 387

Buttons



The dialog comprises at the left side a button bar with the four **trace** buttons for sensor assignment.

The "Save" button enables you to directly store the measured data. The "Config" button opens the corresponding configuration dialog for setting the measurement parameters, as well as the buttons "Marker", "Gate Mode", "Pulse Data" and "Trigger".

Execute the measurement with the Start/Stop button at the bottom.

Trace Buttons - Power Analysis

The four buttons in the upper left corner of the measurement diagram indicate the sensor assignment to the respective trace. They open the settings dialogs for the traces, see "[Setup Trace](#)" on page 175.

Save... - Power Analysis

Opens the dialog to store a screenshot of the current measurement diagram, see "[Save Hardcopy](#)" on page 203.

Config... - Power Analysis

Opens the dialog to configure the power analysis measurement, see

- "[Configure Measurement](#)" on page 179

Marker... - Power Analysis

Opens the dialog to activate the marker indication, see "[Define Markers](#)" on page 202.

Gate Mode... - Power Analysis

Only for measurement mode time and if an R&S NRP-Z81 power sensor is connected.

Opens the dialog to configure the gate settings for pulse data analysis, see "[Configure Gate Mode](#)" on page 186.

Pulse Data... - Power Analysis

Only for measurement mode time and if an R&S NRP-Z81 power sensor is connected.

Opens a dialog to configure the pulse data analysis, see section "[Configure Pulse Data NRP-Z](#)" on page 192.

Trigger... - Power Analysis

Only for measurement mode time.

Opens a dialog to set the trigger for time measurement mode, see "[Configure Trigger](#)" on page 200.

Start - Power Analysis

Triggers the measurements with the R&S NRP-Zxx power sensors. The measurement results are indicated in the measurement diagram. A progress bar indicates the current status of the measurement.

SCPI command:

`:SENSe[:POWER]:SWEep:INITiate` on page 366

*OPC?

`:TRACe<ch>[:POWER]:SWEep:DATA:POINTs` on page 384

`:TRACe<ch>[:POWER]:SWEep:DATA:XVALues` on page 384

`:TRACe<ch>[:POWER]:SWEep:DATA:YVALues` on page 385

Setup Trace

The measurement data can be current (sensor trace) or stored trace data, either in a file (reference trace) or in a temporary memory (hold trace). Up to four traces can be indicated at one time. On connection, the sensors are automatically detected and assigned to a trace. By default, connected sensors are assigned to the traces in ascending order, i.e. sensor 1 to trace 1, sensor 2 to trace 2 and so on. If the default trace is already used, the sensor has to be assigned manually in the trace dialog.

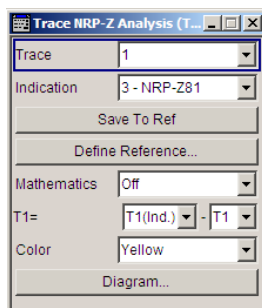

The **reference** and **hold** traces enable you to compare traces. E.g. assign a reference curve to one trace, your measured values to a second one, and switch on display. This feature provides to directly compare results in the graph, or to show deviations in a graph by using the "Mathematics" function.

Example

The current single measurement of sensor 2 which is assigned to trace 2 shall be used as reference trace.

1. Select "Trace 2" with "Indication 2" = NRP-Zx and press the "Save To Ref" button.
2. Select "Trace 1" and "Indication Ref".

3. Press the "Diagram" button, two identical traces are now indicated.
4. Push the "Start single" button and a new measurement cycle with sensor 2 is triggered. The resulting measurement trace can be compared to the former measurement which is visible as reference trace.

Trace

Selects the index of the trace. The source for the trace data is selected below. The trace color for each of the four possible traces is preset but can be changed.

SCPI command:

n.a.

In remote control, the trace is selected by the suffix of keyword `TRACe`.

Indication - Power Analysis

Selects the source for the trace data.

The selection is indicated on the trace button in the measurement diagram.

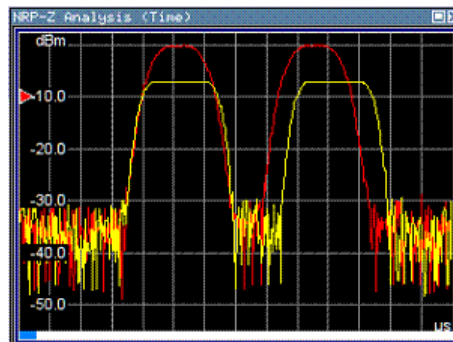

Red = reference or hold trace

Yellow = current measurement trace

"Off" No source is selected, the trace is not indicated.

SCPI command:

`:TRACe<ch>[:POWer]:SWEep:STATe` on page 391

"2 - NRP-Zxx" The current measurement results of the selected power sensor are the source for the trace data. The index at the beginning of the sensor name indicates the used connector, e.g. 2 indicates that the sensor is connected via a USB interface. The data are either continuously updated (continuous measurement) or represent a single measurement cycle (single measurement).

SCPI command:

`:TRACe<ch>[:POWer]:SWEep:STATe` on page 391

`:TRACe<ch>[:POWer]:SWEep:FEED` on page 385

"Ref" Selects the reference trace. The reference trace represents the state of the sensor trace at the moment when it was stored. The reference trace is a static trace that was stored in a file and can be recalled. It is possible to store one reference trace at a time.

SCPI command:

:TRACe<ch>[:POWer]:SWEep:COpy on page 384
 :TRACe<ch>[:POWer]:SWEep:FEED on page 385
 :TRACe<ch>[:POWer]:SWEep:STATe on page 391

"Hold" Freezes the current trace data. The hold trace is a temporary trace that is available until the NRP power analysis is finished. Freezing the trace of a sensor on one trace and displaying the measurement values of the same sensor on a other trace allows fast comparison between measurements.

SCPI command:

n.a.

(this feature is available for manual control only)

Save to Ref - Trace Power Analysis

Saves the selected trace as reference trace. One reference trace is available at a time.

SCPI command:

:TRACe<ch>[:POWer]:SWEep:COpy on page 384

Define Reference - Trace Power Analysis

Opens a dialog for defining a linear reference curve.

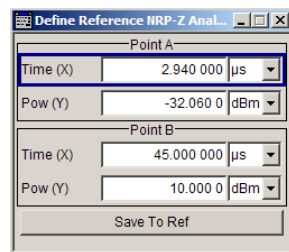

Define the reference curve by entering the coordinates of "Point A" and "Point B".

The reference curve is determined by two value pairs in the cartesian coordinates of the "NRP-Z Analysis" diagram. Depending on the measurement mode, the following values are required:

- Freq (X) / Pow (Y) in "Frequency" mode
 Determine the parameters of the frequency reference curve.
 :SENSe[:POWer]:SWEep:FREQuency:REFerence:DATA:XVALues on page 351
 :SENSe[:POWer]:SWEep:FREQuency:REFerence:DATA:YVALues on page 351
- Pow (X) / Pow (Y) in "Power" mode
 Enter the x- and y-axis values of the points A and B.
 :SENSe[:POWer]:SWEep:POWer:REFerence:DATA:XVALues on page 367
 :SENSe[:POWer]:SWEep:TIME:REFerence:DATA:COpy on page 375
- Time (X) / Pow (Y) in "Time" mode

Enter the time values for the x-axis and the corresponding y-axis power values.

:SENSe[:POWER]:SWEep:TIME:REFerence:DATA:XVALues on page 375

:SENSe[:POWER]:SWEep:TIME:REFerence:DATA:YVALues on page 376

- "Save To Ref"

Saves the selected trace as reference trace. One reference trace is available at a time.

:SENSe[:POWER]:SWEep:FREQuency:REFerence:DATA:COPI on page 351

:SENSe[:POWER]:SWEep:POWER:REFerence:DATA:YVALues on page 367

:SENSe[:POWER]:SWEep:TIME:REFerence:DATA:COPI on page 375

The reference curve consists of a certain number of coordinate points, calculated by the number of steps + 1. The first coordinate point starts at Min, and Max is the last. "Step", "Min" and "Max" are determined in the configuration dialog, see "[Configure Measurement](#)" on page 179.

Tip: You can assign the X and Y coordinates of the markers automatically in marker view. By pressing the "Fill Point" button, the function automatically reads the X and Y coordinates from the trace data and derives the intersection point of the selected marker and the trace curve.

Mathematics - Trace Power Analysis

Activates / deactivates the mathematic function.

The function allows to determine the deviation of two test series, either of measurement traces, or also of traces that contain math results or stored reference curves. I.e. you can also assign a math result to an operand for further calculation. Various nested computation steps are possible.

The math operation follows the formula:

$$T<ch>_{\text{result}} = T<ch>_{\text{Operand1}} - T<ch>_{\text{Operand2}}$$

How to proceed:

Determine $T<ch>_{\text{Operand1}}$ in the entry field next to "Tx", and then select $T<ch>_{\text{Operand2}}$ in the second entry field right to it.

The result (" $T<ch>_{\text{result}}$ ") is assigned to the above selected "Trace". If switched on, the graph shows the resulting curve.

Note:

Depending on the type of trace, the instrument automatically sets the appropriate unit on the y-axis:

- "dBm" if it shows only measurement traces.
- "dB" for purely mathematical curves.
- "dB/dBm" ratio scale for mixed display, i.e. measurements and mathematical curves.

Example:

Example of a nested calculation.

- T1 shows the result of the subtraction of the trace ("Trace 1"), and the reference curve.

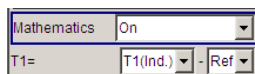

- Trace2 subtracts Ref from T1.

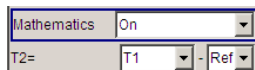

That illustrates the nested calculation, since T1 covers already a math operation.

Note: "(Ind.)" denotes the currently selected trace.

SCPI command:

[:CALCulate\[:POWER\]:SWEep:FREQuency:MATH<ch>:STATe](#) on page 339

[:CALCulate\[:POWER\]:SWEep:FREQuency:MATH<ch>:SUBTract](#) on page 339

[:CALCulate\[:POWER\]:SWEep:POWer:MATH<ch>:STATe](#) on page 340

[:CALCulate\[:POWER\]:SWEep:POWer:MATH<ch>:SUBTract](#) on page 340

[:CALCulate\[:POWER\]:SWEep:TIME:MATH<ch>:STATe](#) on page 340

[:CALCulate\[:POWER\]:SWEep:TIME:MATH<ch>:SUBTract](#) on page 341

Color - Trace Power Analysis

Selects the color of the trace.

SCPI command:

[:TRACe<ch>\[:POWER\]:SWEep:COLor](#) on page 383

Diagram.. - Power Analysis

Returns to the "NRP-Z Analysis Diagram".

Configure Measurement

To open the "Configure NRP-Z Analysis" dialog, press the "Config..." button. The dialog is divided into several sections. The measurement section provides start and stop values for the sweep, and the corresponding parameters for the selected measurement mode.

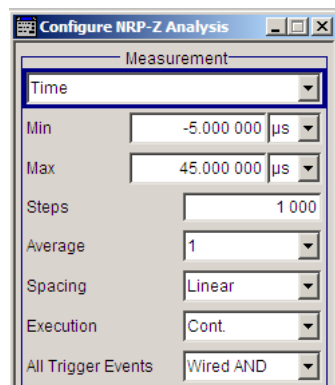
**Measurement Mode - Power Analysis**

Selects the measurement mode.

"Frequency"	Power versus frequency measurement (frequency response).
"Power"	Power versus power measurement (power sweep, AM/AM).
"Time"	Power versus time measurement (envelope power measurement as a function of time, NRP trace mode). This is done by sampling power over a time interval and then assigning the internal power values that have been determined to a number of points. This mode also provides gated measurement and pulse data analysis, e.g. with a connected R&S NRP-Z81, and the corresponding graphical display "Gate View" and "Pulse Data View".

SCPI command:

[SENSe\[:POWER\]:SWEep:MODE](#) on page 366

Min - Power Analysis

Enters the minimum frequency/power/time of the measurement.

The available frequency/power range depends on the frequency/power range of the generator and the used power sensor.

The range for the start time is -1s to +1s. Value 0 defines the trigger point. By choosing a negative time value, the trace can be shifted in the diagram.

It is possible, that the measurement cannot be performed over the complete time range because of limitations due to sensor settings. In this case, an error message is output.

If this value is changed for a finished single measurement, only the scaling of the x-axis is changed. This allows to zoom the trace. However, for subsequent measurements the measurement range is changed according to the new setting.

If this value is changed during a continuous measurement, only the scaling of the x-axis is changed for measurement cycles that still were triggered before the change. For subsequent measurement cycles the measurement range is changed according to the new setting.

SCPI command:

[:SENSe\[:POWER\]:SWEep:FREQuency:STARt](#) on page 354

[SENSe\[:POWER\]:SWEep:POWER:STARt](#) on page 371

[SENSe\[:POWER\]:SWEep:TIME:STARt](#) on page 378

Max - Power Analysis

Enters the maximum frequency/power/time of the measurement.

The available frequency/power range depends on the frequency/power range of the instrument and the used power sensor.

The range for the stop time is 0 s to 2 s. Value 0 defines the trigger point.

It is possible, that the measurement cannot be performed over the complete time range because of limitations due to sensor settings. In this case, an error message is output.

If this value is changed for a finished single measurement, only the scaling of the x-axis is changed. This allows to zoom the trace. However, for subsequent measurements the measurement range is changed according to the new setting.

If this value is changed during a continuous measurement, only the scaling of the x-axis is changed for measurement cycles that still were triggered before the change. For subsequent measurement cycles the measurement range is changed according to the new setting.

SCPI command:

[:SENSe\[:POWer\]:SWEep:FREQuency:STOP](#) on page 355

[SENSe\[:POWer\]:SWEep:POWer:STOP](#) on page 372

[SENSe\[:POWer\]:SWEep:TIME:STOP](#) on page 379

Steps - Power Analysis

Enters the number of steps for the sweep. The number of measured points is steps + 1. The number of steps is one of the parameters that define the measurement speed. The higher the number of step, the longer the measurement takes (frequency and power mode).

SCPI command:

[:SENSe\[:POWer\]:SWEep:FREQuency:STEPS](#) on page 354

[SENSe\[:POWer\]:SWEep:POWer:STEPS](#) on page 371

[SENSe\[:POWer\]:SWEep:TIME:STEPS](#) on page 379

Timing - Power Analysis

Frequency and power mode only.

Selects the timing mode of the measurement in frequency and power mode. This parameter is not available in time mode.

"Fast" Fast measurement with an integration time of 2 ms for each measurement step.

"Normal" A longer but more precise measurement (integration time is 20 ms/step).

SCPI command:

[:SENSe\[:POWer\]:SWEep:FREQuency:TIMing\[:MODE\]](#) on page 355

[SENSe\[:POWer\]:SWEep:POWer:TIMing\[:MODE\]](#) on page 372

Average - Power Analysis

Time mode only

Selects the averaging factor in time mode. This parameter is not available in frequency and power mode.

The factor determines how many measurement cycles are used to form a measurement result. Higher averaging counts reduce noise but increase the measurement time. Averaging requires a stable trigger event so that the measurement cycles have the same timing. If factor 1 is selected no averaging is performed.

SCPI command:

[:SENSe\[:POWer\]:SWEep:TIME:AVERAge\[:COUNT\]](#) on page 375

Spacing - Power Analysis

Sets the mode for calculating the sweep steps.

In power versus frequency mode, selection between linear and logarithmic spacing is possible.

- "Linear"
- Power versus frequency
In a linear sweep, the frequency is swept in equidistant steps over the continuous frequency range. The x-axis is a linear frequency axis.
 - Power versus power
The sweeps are performed at constant frequency but with variable generator power that is swept in linear, equidistant steps over a continuous range. The x-axis is a dB-linear power axis.
 - Power versus time
The sweeps are performed at constant frequency and stimulus power. The measurement is repeated over a specified period of time at constant time intervals.
- "Logarithmic" Power versus frequency
In a logarithmic sweep, the frequency is swept in equidistant steps on a logarithmic scale. The x-axis is a logarithmic frequency axis.

SCPI command:

[:SENSe\[:POWer\]:SWEep:FREQuency:SPACing\[:MODE\]](#) on page 354

[:SENSe\[:POWer\]:SWEep:POWer:SPACing\[:MODE\]](#) on page 371

[:SENSe\[:POWer\]:SWEep:TIME:SPACing\[:MODE\]](#) on page 378

Execution - Power Analysis

Selects single or continuous mode in power analysis.

The measurement is started in the diagram using the "Start" button. During measurement, the "Start" button is replaced by a "Stop" button which can be used to abort the measurement. The progress bar indicates the current status of the measurement.

Note: For time mode an additional trigger is required (see ["Configure Trigger"](#) on page 200).

"Single" Selects single measurement.

"Cont." Selects continuous measurements.

SCPI command:

[:SENSe\[:POWer\]:SWEep:RMODE](#) on page 374

[:SENSe\[:POWer\]:SWEep:FREQuency:RMODE](#) on page 352

[:SENSe\[:POWer\]:SWEep:POWer:RMODE](#) on page 367

[:SENSe\[:POWer\]:SWEep:TIME:RMODE](#) on page 374

All Trigger Events - Power Analysis

"All Trigger Events" determines, whether the measurement data processing starts with a trigger event in one of the sensors (Logical OR), or whether all channels have to be triggered (logical AND). Each sensor evaluates a trigger event according to its setting independently.

This function supports the internal or external trigger modes with multi-channel time measurements.

"Wired AND" When all channels are triggered, the measurement starts.

"Wired OR" The measurement starts when a trigger event occurs.

SCPI command:

[:SENSe\[:POWER\]:SWEep:TIME:TEVents](#) on page 379

Configure Diagram

The "Configure NRP-Z Analysis" dialog is divided into several sections. The diagram area covers the parameters for scaling the y-axis and the appearance of the diagram.

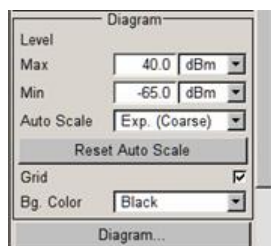

Min - Max y-Axis - Power Analysis

Selects the minimum and maximum value of the y-axis.

SCPI command:

[:SENSe\[:POWER\]:SWEep:FREQuency:YSCale:MAXimum](#) on page 356

[:SENSe\[:POWER\]:SWEep:FREQuency:YSCale:MINimum](#) on page 357

[SENSe\[:POWER\]:SWEep:POWER:YSCale:MAXimum](#) on page 373

[SENSe\[:POWER\]:SWEep:POWER:YSCale:MINimum](#) on page 374

[SENSe\[:POWER\]:SWEep:TIME:YSCale:MAXimum](#) on page 381

[SENSe\[:POWER\]:SWEep:TIME:YSCale:MINimum](#) on page 381

Auto Scale - Power Analysis

Activates/deactivates autoscaling of the y-axis of the diagram. The Auto Scale function adjusts the scale divisions so that the entire trace fits into the diagram area.

"Off" Auto scale is deactivated. Switching from activated to deactivated, the scaling is maintained.

"Exp. (Course/
Fine)" Auto scale is activated. Automatically selects the appropriate scaling of the y-axis so that the trace is always visible. The range is expanded when a value is out of the right or the left end-of-scale value. The step width is 5 dB for selection "Exp. (Coarse)" and variable in the range of 0.2 db to 5 dB for selection "Exp. (Fine)".

"Flt. (Course/
Fine)" Auto scale is activated, i.e. this parameter automatically selects the appropriate scaling of the y-axis so that the trace is always visible. The range is either expanded, when a value is out of the right/left end-of-scale value or it is reduced when the trace fits into a smaller scale area. The step width is 5 dB for selection "Flt. (Coarse)" and variable in the range of 0.2 db to 5 dB for selection "Flt. (Fine)".

SCPI command:

[:SENSe\[:POWER\]:SWEep:FREQuency:YSCale:AUTO](#) on page 355

[SENSe\[:POWER\]:SWEep:POWER:YSCale:AUTO](#) on page 372

[SENSe\[:POWER\]:SWEep:TIME:YSCale:AUTO](#) on page 380

Reset Auto Scale - Power Analysis

Resets the scaling of the y-axis to suitable values after the use of auto scaling in the expanding mode. For this mode, the Y scale might get too expanded because of temporarily high power values. The reset function resets the diagram again, to also indicate smaller power values.

SCPI command:

`:SENSe[:POWer]:SWEep:FREQuency:YSCale:AUTO:RESet` on page 356

`SENSe[:POWer]:SWEep:POWer:YSCale:AUTO:RESet` on page 373

`SENSe[:POWer]:SWEep:TIME:YSCale:AUTO:RESet` on page 380

Grid - Power Analysis

Activates/deactivates the indication of a grid in the diagram area.

SCPI command:

`:DISPlay[:WINDow][:POWer]:SWEep:GRID:STATe` on page 341

Bg Color - Power Analysis

Selects the background color of the diagram, black or white. The background color is also effective for the hardcopy of the diagram.

SCPI command:

`:DISPlay[:WINDow][:POWer]:SWEep:BACKground:COLor` on page 341

REARR list - Power Analysis

The "REARR list..." button in the middle section opens the dialog for selection of diagram views. This function provides to activate only the required "Views" on the checkboxes to the right. REARR or STRG+<A> switches between all views that are activated in this dialog.

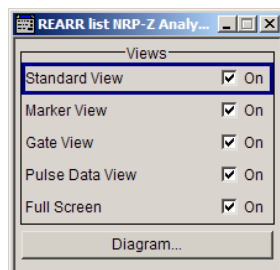

Viewing modes of frequency power and level sweep timing measurements:

- "Standard View:" shows the graph and the button bar at the left

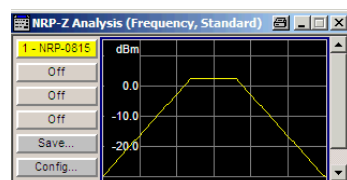

- "Marker View:" shows the graph and the corresponding marker values at the bottom

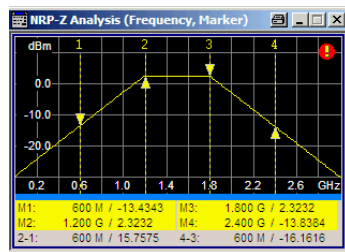

- "Full Screen:" shows the graph in fullscreen, and fades out buttons and list values

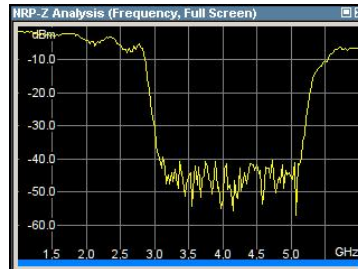

Viewing modes of time trace and pulse data measurements:

- "Gate View:" shows the graph with the corresponding gate data. Gate view provides indicating time trace measurements, as e.g. the peak envelope power of the RF signal.

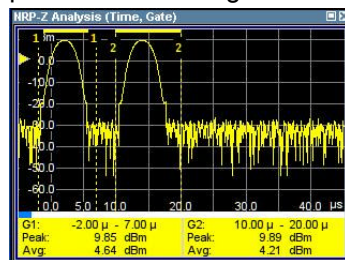

Note: This view is selectable in time mode, since gate measurement is a function of time.

- "Pulse Data View:" shows the graph and the corresponding pulse data. Pulse data view indicates pulse data measurement results of the R&S NRP-Z8x sensor family.

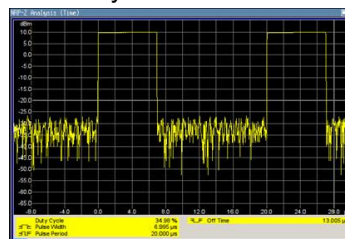

Note: This view is selectable in time mode, since pulse data measurement is a function of time.

Note: The toggle function always switches sequentially between the activated views. When you disable a view that is currently shown, the instrument automatically switches to the next active view.

At least one view must be active, i.e. the final active view cannot be switched off.

SCPI command:

`:TRACe[:POWer]:SWEep:MEASurement:STANdard:DISPlay:ANNotation[:STATe]` on page 388

`:TRACe[:POWer]:SWEep:MEASurement:MARKer:DISPlay:ANNotation[:STATe]` on page 386

`:TRACe[:POWer]:SWEep:MEASurement:GATE:DISPlay:ANNotation[:STATe]` on page 386

`:TRACe[:POWer]:SWEep:MEASurement:PULSe:DISPlay:ANNotation[:STATe]` on page 387

`:TRACe[:POWer]:SWEep:MEASurement:FULLscreen:DISPlay:ANNotation[:STATe]` on page 386

Pressing the "Diagram..." button returns to the "NRP-Z Analysis" diagram.

Gate Mode - Power Analysis

The "Gate Mode..." button opens the subdialog for the gate mode settings (see "[Configure Gate Mode](#)" on page 186).

Diagram.. - Power Analysis

Returns to the "NRP-Z Analysis Diagram".

Configure Gate Mode

The "Configure NRP-Z Analysis" dialog is divided into several sections. The "Gate Mode..." button in the middle section opens the dialog for time gate settings.



For time measurement mode only.

Almost all R&S NRP sensors also support time gated measurements of peak and average power (see the data sheet or operating manual of the respective sensor). Two user-configurable gates can be assigned to one of the traces. Both gates are active at the same time. The values are calculated from the trace data, the time resolution is determined by the resolution of the sensor. An external trigger signal or signal triggering is required for synchronization.

The following graph shows two measurement examples, one with separated gates, and another one with overlapping gates.

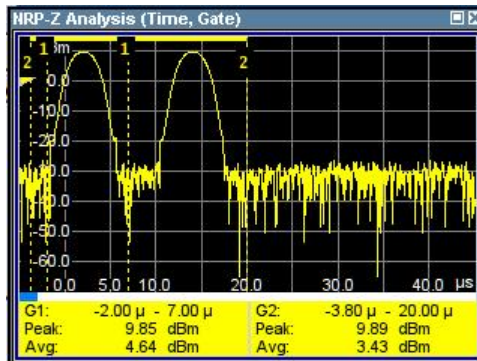
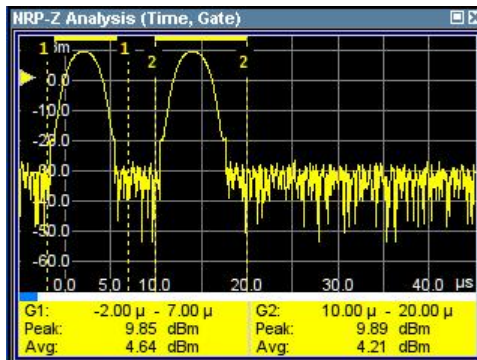

The start and stop time of the gates are indicated as gate markers, a bar between the start and stop marker shows the gate length. The indication state of the gate borders and measurement values is only available for certain diagram views which are switched with the "REARR" key. The "REARR list NRP-Z Analysis dialog" dialog provides a selection of views, between which is toggled (see "REARR list - Power Analysis" on page 184).

Gate Mode NRP-Z Analysis

Trace: 1

Indication: 1 - NRP-ZB1

State: On

Gate 1

Start: 5.000 000 μs

Stop: 15.000 000 μs

Gate 2

Start: 25.000 000 μs

Stop: 35.000 000 μs

Diagram...



In the remote control mode, commands for setting the indication state differ from the commands for reading the measurement values.

- **Command that defines the indication state for the diagram and for hardcopy:**
:TRACe[:POWer]:SWEep:MEASurement:GATE:DISPlay:ANNotation[:STATE] on page 386
- **Commands that query the measured values:**
:CALCulate[:POWer]:SWEep:TIME:GATE<ch>AVERage on page 337
queries the measured average power.
:CALCulate[:POWer]:SWEep:TIME:GATE<ch>MAXimum on page 338
queries the measured peak power.

Trace - Gate

Selects the trace to which the gates are assigned. The sensor assignment to the respective trace is performed in the measurement diagram (trace buttons). The two gates are assigned to the same trace.

SCPI command:

:CALCulate[:POWer]:SWEep:TIME:GATE<ch>:FEED on page 338

Indication

(time measurement mode only)

Indicates the type of R&S NRP power sensor assigned to the selected trace. This field is automatically updated if the sensor is connected or disconnected. Additionally, this sensor is indicated on the trace button in the measurement diagram.

SCPI command:

n.a.

State - Gate

Enables time gated measurement. The measurement is started with the "Start" button in the main measurement diagram. Both gates are active at one time.

The gate borders and the measurement values (average and peak power) are indicated in/below the measurement diagram. The indication is only available for certain diagram views which are switched with the "Rearrange" key.

SCPI command:

:CALCulate[:POWer]:SWEep:TIME:GATE<ch>:STATE on page 339

:CALCulate[:POWer]:SWEep:TIME:GATE<ch>AVERage on page 337

:CALCulate[:POWer]:SWEep:TIME:GATE<ch>MAXimum on page 338

:TRACe[:POWer]:SWEep:MEASurement:GATE:DISPlay:ANNotation[:STATE] on page 386

Start / Stop - Gate

Sets the start and the stop times for the respective gate.

SCPI command:

:CALCulate[:POWer]:SWEep:TIME:GATE<ch>START on page 339

Diagram... - Power Analysis

Returns to the "NRP-Z Analysis" Diagram.

Configure Sensors

The "Configure NRP-Z Analysis" dialog is divided into several sections. The power sensor area additionally provides specific parameters for the power sensor. This part of the dialog might differ from the following description depending on the sensor used. Refer to the manual of the power sensor in this case.

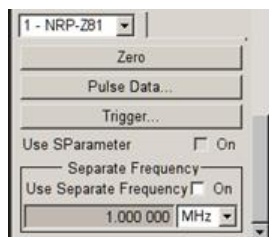

The "Pulse Data..." button is displayed only for measurement mode time and if an R&S NRP-Z81 power sensor is connected.

Power Sensor - Power Analysis

Selects the power sensor to be set if more than one sensor is connected to the instrument.

SCPI command:

n.a.

In remote control the sensor is selected via the numeric suffix in the sense key word of the command, e.g. `SENSe2:POWer:SWEep:...`

Zero - Power Analysis

Activates the auto zero function.

Zeroing calibrates the external power sensor by adjusting its reading at zero signal power. For this purpose, the RF power source must be switched off or disconnected from the sensor (see tips below). R&S power sensors automatically detect the presence of any significant input power. This aborts zeroing and generates an error message. Zeroing can take a few seconds, depending on the sensor model; refer to the documentation of your external power sensor for more information.

Tips for zeroing

Zeroing should be performed:

- During warm-up after switching on or connecting the instrument
- After a substantial change of the ambient temperature
- After fastening the power sensor module to an RF connector at high temperature
- After several hours of operation
- When very low-power signals are to be measured, e.g. less than 10 dB above the lower measurement limit.
- Switch off the RF power source for zeroing; do not disconnect it from the power sensor. In this way you will maintain the thermal equilibrium, and zeroing will also com-

compensate for the noise superimposed on the measured signal (e.g. from a broadband amplifier).

SCPI command:

[SENSe<ch>\[:POWER\]:ZERO](#) on page 381

Pulse Data... - Power Analysis

Only for measurement mode time and if an R&S NRP-Z81 power sensor is connected.

Opens the "Pulse Data NRP-Z-Analysis" dialog for configuring the parameters for pulse data analysis (see ["Configure Pulse Data NRP-Z"](#) on page 192).

SCPI command:

n.a.

Trigger... - Power Analysis

Only for measurement mode time.

Opens a settings dialog to set the trigger for time measurement mode, see ["Configure Trigger"](#) on page 200.

Use S-Parameter - Power Analysis

Activates the use of the s-parameters correction data of the connected power sensor. For sensors with attenuator this checkbox is automatically checked.

Refer also to the manual of the connected R&S NRP power sensor for a description on how to use the s-parameters table.

SCPI command:

[SENSe<ch>\[:POWER\]:CORRection:SPDevice:STATe](#) on page 345

Level Offset State- Power Analysis

Activates a level offset at the sensor input. Enter the appropriate value in the entry field on the right, see [Level Offset - Power Analysis](#).

SCPI command:

[:SENSe<ch>\[:POWER\]:SWEep:FREQuency\[:SENSor\]:OFFSet:STATe](#)
on page 352

[:SENSe<ch>\[:POWER\]:SWEep:POWer\[:SENSor\]:OFFSet:STATe](#) on page 368

[:SENSe<ch>\[:POWER\]:SWEep:TIME\[:SENSor\]:OFFSet:STATe](#) on page 369

Level Offset - Power Analysis

Enters the level offset at the sensor input. To take the value into account, activate the offset with ["Level Offset State- Power Analysis"](#) on page 190.

SCPI command:

[:SENSe<ch>\[:POWER\]:SWEep:FREQuency\[:SENSor\]:OFFSet](#) on page 352

[:SENSe<ch>\[:POWER\]:SWEep:POWer\[:SENSor\]:OFFSet](#) on page 367

[:SENSe<ch>\[:POWER\]:SWEep:TIME\[:SENSor\]:OFFSet](#) on page 368

Use Separate Frequency- Power Analysis

This setting is offered for measurements with DUTs that change the measurement frequency (e.g. modulators), thus changing the input frequency of the sensor.

The dialog differs depending on the measurement modes:

- Power versus frequency measurement
Activates the use of a different frequency range other than the set signal generator frequency range for the measurement. The separate minimum and maximum frequency values are entered below.
The x-scale of the diagram can be adjusted to the separate frequency range with functions "Use as X Scale" and "Map to X Scale".

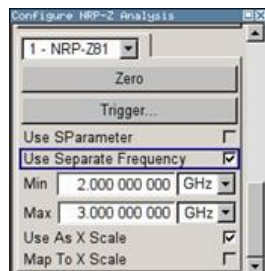

- Power versus power measurement / Power versus time measurement
Activates the use of a different frequency other than the set signal generator frequency for the measurement. The separate frequency value is entered in the entry window below.

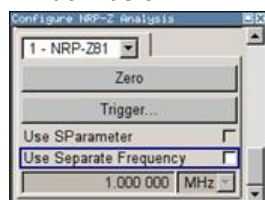

SCPI command:

`:SENSe<ch>[:POWER]:SWEep:FREQuency[:SENSor]:SRANge[:STATe]`
on page 353

`SENSe<ch>[:POWER]:SWEep:POWER[:SENSor]:SFRequency:STATe`
on page 368

`SENSe<ch>[:POWER]:SWEep:POWER[:SENSor]:SFRequency` on page 368

`SENSe<ch>[:POWER]:SWEep:TIME[:SENSor]:SFRequency:STATe` on page 376

`SENSe<ch>[:POWER]:SWEep:TIME[:SENSor]:SFRequency` on page 376

Min Frequency - Power Analysis

Power versus frequency measurement active Use Separate Frequency only.

Enters the minimum frequency of the measurement.

SCPI command:

`:SENSe<ch>[:POWER]:SWEep:FREQuency[:SENSor]:SRANge:START`
on page 353

Max Frequency - Power Analysis

Power versus frequency measurement active Use Separate Frequency only.

Enters the maximum frequency of the measurement.

SCPI command:

`:SENSe<ch>[:POWER]:SWEep:FREQuency[:SENSor]:SRANge:STOP`
on page 353

Use as X Scale - Power Analysis

Measurement Mode Frequency only.

Activates the use of the separate frequency min and max values for the scaling of the x-axis. Thus, the trace for this sensor is visible in the diagram, especially for frequency ranges that differ substantially from the generator settings.

If more than one sensor is active and uses separate frequency, this options is only available for one sensor. To indicate the traces of the other sensors, function "Map to X Scale" has to be used.

SCPI command:

n.a.

Map to X Scale - Power Analysis

Mode Frequency and active Use Separate Frequency only.

Maps the trace of a sensor that uses separate frequency to the current scaling of the diagram. Usually the scale is determined by the set frequency range of the generator. If more than one sensor is active and uses separate frequency the scale can also be determined by the separate frequency range of one of the other sensors.

SCPI command:

n.a.

Configure Pulse Data NRP-Z

For time measurement mode and power sensor R&S NRP-Z81 only.

The power sensors R&S NRP-Z81 enable pulse data analysis in measurement mode time. All important pulse parameters are measured after setting the threshold levels. The following graph shows most of these parameters:

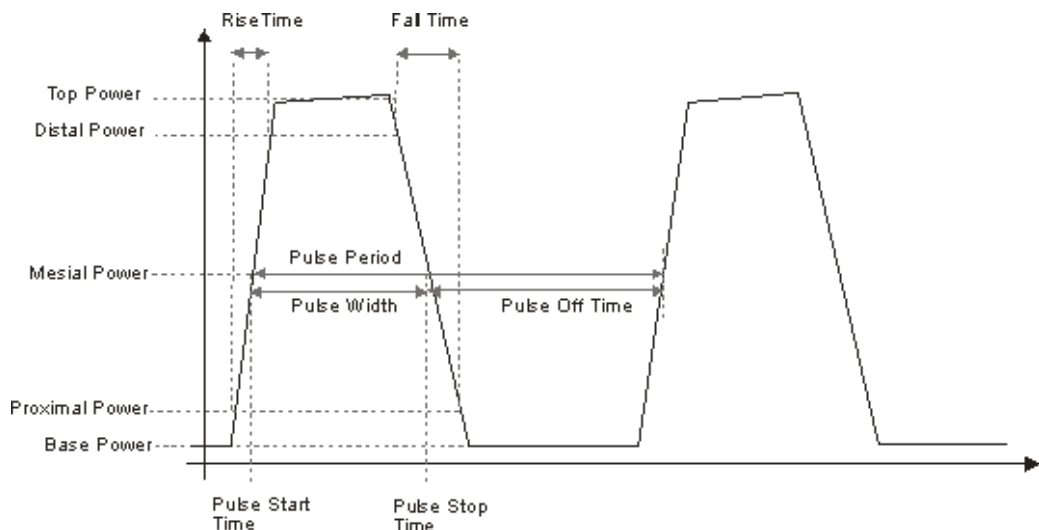

The sensor calculates the pulse parameters from each measurement. The sensor delivers the results to the R&S signal generator.

The "Pulse Data" button opens the submenu to configure and enable pulse data analysis:

- The "Pulse Data NRP-Z- Analysis" dialog is divided into several sections. In the upper section the trace is selected and the pulse data analysis enabled. For information on traces and the measurement data on traces refer to ["Setup Trace"](#) on page 175.
- The "Thresholds" section covers the thresholds for detecting time values of a pulsed signal. Thresholds are used to calculate the time parameters. The thresholds can either be related to power or voltage. For information on parameters and terms refer to ["Voltage / Power Related - Pulse Data Analysis"](#) on page 194, ["Mesial - Pulse Data Analysis"](#) on page 195 and ["Proximal - Pulse Data Analysis"](#) on page 195.
- The "Notifications" section covers Duty Cycle, Pulse Width, Pulse Period and Pulse Off Time (see ["Notifications - Pulse Data Analysis"](#) on page 195).
- The "Transition Times" section covers Rise Time, Pulse Start Time, Overshoot for the rising or falling edges, Fall Time and Pulse Stop Time (see ["Transition Times - Pulse Data Analysis"](#) on page 197).
- The "Signal Power" section covers Minimal Power, Peak Power and Average Power (see ["Signal Power - Pulse Data Analysis"](#) on page 198).
- The "Pulse Power" section covers Top Power and Base Power, and Mesial Proximal and Distal Power (see ["Pulse Power - Pulse Data Analysis"](#) on page 199).

The indication state of the parameters also affects the hardcopy function. Storing the measurement diagram as hardcopy includes the parameters selected in this dialog. For information on storing measurement data refer to ["Save Hardcopy"](#) on page 203.



A total of 6 parameters can be indicated at one time. Structured hierarchically, trace 1 features top priority and trace 4 is addressed with the lowest weighting. This means that only the first 6 checked parameters are indicated, starting with the settings of trace 1.

The pulse data is only visible for certain zoom levels of the diagram. The REARRANGE key or the key combination <STR+A> on an external keyboard toggles between the different zoom levels.

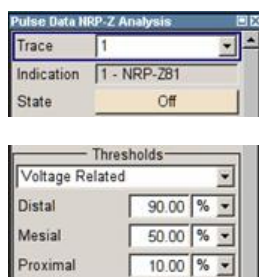



In the remote control mode, commands for setting the indication state differ from the commands for reading the values of the corresponding pulse data parameters.

In the description of the checkboxes, the different remote control commands are listed as shown in the example below:

- Commands that define the indication state for the diagram and for hardcopy:
`:TRACE<ch>[:POWer]:SWEep:MEASurement:PULSe:DCYCLe:DISPlay:ANNotation[:STATe]` on page 388
 activates indication of the measured duty cycle.
- Commands that define the indication state for the diagram and for hardcopy:
`:TRACE<ch>[:POWer]:SWEep:MEASurement:POWer:PULSe:TOP:DISPlay:ANNotation[:STATe]` on page 389
 activates indication the measured top level.
- Commands that query the measured values:
`:TRACe<ch>[:POWer]:SWEep:MEASurement:PULSe:DCYCLe` on page 387
 queries the measured duty cycle.
- Commands that query the measured values:
`:TRACe<ch>[:POWer]:SWEep:MEASurement:POWer:PULSe:TOP`
 on page 386
 queries the measured top level.

Trace

Selects the index of the trace. The source for the trace data is selected below. The trace color for each of the four possible traces is preset but can be changed.

SCPI command:

n.a.

In remote control, the trace is selected by the suffix of keyword `TRACe`.

Indication

(time measurement mode only)

Indicates the type of R&S NRP power sensor assigned to the selected trace. This field is automatically updated if the sensor is connected or disconnected. Additionally, this sensor is indicated on the trace button in the measurement diagram.

SCPI command:

n.a.

State - Pulse Data Analysis

Enables pulse data analysis. The measurement is started with the "Start" button in the main measurement diagram.

SCPI command:

`:SENSe<ch>[:POWer]:SWEep:TIME[:SENSor]:PULSe:STATe` on page 369

Voltage / Power Related - Pulse Data Analysis

Selects how the threshold parameters are calculated, either voltage related or power related. The voltage-related parameters represent the normal case, as the usual representation when defining the pulse parameters (rise/fall time, pulse width) is $U(t)$. To achieve a display with equivalent power-related values, the voltage-related threshold values must be converted (squared) (see example in table below).

	Distal	Mesial	Proximal
Voltage related:	90%	50%	10%
Power related:	81%	25%	1 %
log. Scale (e.g.): (approx., difference between top- base power > 30 dB)	-0.9dB	-6dB	-20dB

SCPI command:

`SENSe<ch>[:POWER]:SWEep:TIME[:SENSor]:PULSe:THReshold:BASE`
on page 369
`:TRACe<ch>[:POWER]:SWEep:PULSe:THReshold:BASE` on page 389

Distal - Pulse Data Analysis

Sets the upper reference level in terms of percentage of the overall pulse level (power or voltage related). The distal power defines the end of the rising edge and the start of the falling edge of the pulse.

SCPI command:

`:SENSe<ch>[:POWER]:SWEep:TIME[:SENSor]:PULSe:THReshold:POWER:HREFerence`
on page 370
`:TRACe<ch>[:POWER]:SWEep:PULSe:THReshold:POWER:HREFerence`
on page 390

Mesial - Pulse Data Analysis

Sets the medial reference level in terms of percentage of the overall pulse level (power or voltage related). This level is used to define the pulse width (τ) and pulse period.

SCPI command:

`:SENSe<ch>[:POWER]:SWEep:TIME[:SENSor]:PULSe:THReshold:POWER:REFerence`
on page 370
`:TRACe<ch>[:POWER]:SWEep:PULSe:THReshold:POWER:REFerence`
on page 390

Proximal - Pulse Data Analysis

Sets the lower reference level in terms of percentage of the overall pulse level (power or voltage related).

The proximal power defines the start of the rising edge and the end of the falling edge of the pulse.

SCPI command:

`:SENSe<ch>[:POWER]:SWEep:TIME[:SENSor]:PULSe:THReshold:POWER:LREFerence`
on page 371
`:TRACe<ch>[:POWER]:SWEep:PULSe:THReshold:POWER:LREFerence`
on page 390

Notifications - Pulse Data Analysis

Selects the pulse parameters to be indicated below the measurement diagram.

Note: The "Rearrange" key or the key combination <STR+A> toggle between the diagram views.

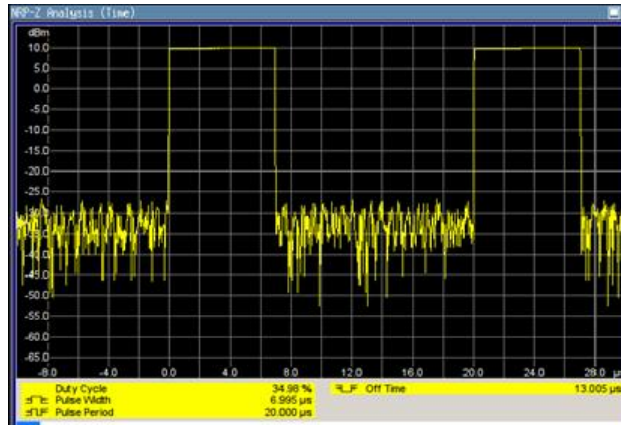
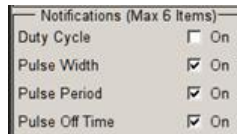

"Duty Cycle" Indicates the ratio between the pulse duration (τ) and the pulse period (T) of the measured pulse signal in per cent:

$$\text{Duty Cycle} = (\text{pulse duration} / \text{pulse period}) * 100$$

SCPI command:

`:TRACE<ch>[:POWER]:SWEep:MEASurement:PULSe:DCYCLe:DISPlay:`

`ANNOtation[:STATe]` on page 388

`:TRACe<ch>[:POWER]:SWEep:MEASurement:PULSe:DCYCLe` on page 387

"Pulse Width" Indicates the pulse duration of the pulse data measurement in seconds.

SCPI command:

`:TRACE<ch>[:POWER]:SWEep:MEASurement:PULSe:DURation:DISPlay:`

`ANNOtation[:STATe]` on page 388

`:TRACe<ch>[:POWER]:SWEep:MEASurement:PULSe:DURation` on page 387

"Pulse Period" Indicates the time the pulse signal needs to complete one cycle.

SCPI command:

`:TRACE<ch>[:POWER]:SWEep:MEASurement:PULSe:PERiod:DISPlay:`

`ANNOtation[:STATe]` on page 388

`:TRACe<ch>[:POWER]:SWEep:MEASurement:PULSe:PERiod` on page 387

"Pulse Off Time" Determines the time the pulse signal is low, i.e. as long as the signal level is below the proximal value.

SCPI command:

`:TRACE<ch>[:POWER]:SWEep:MEASurement:PULSe:SEParation:DISPlay:`

`ANNOtation[:STATe]` on page 389

`:TRACe<ch>[:POWER]:SWEep:MEASurement:PULSe:SEParation` on page 387

Transition Times - Pulse Data Analysis

Selects the transition parameters of the pulse signal to be indicated below the measurement diagram.

The R&S NRP-Z sensor searches for the first rising edge and the first falling edge in the trace.

Note: The "Rearrange" key or the key combination <STR+A> toggle between diagram views.

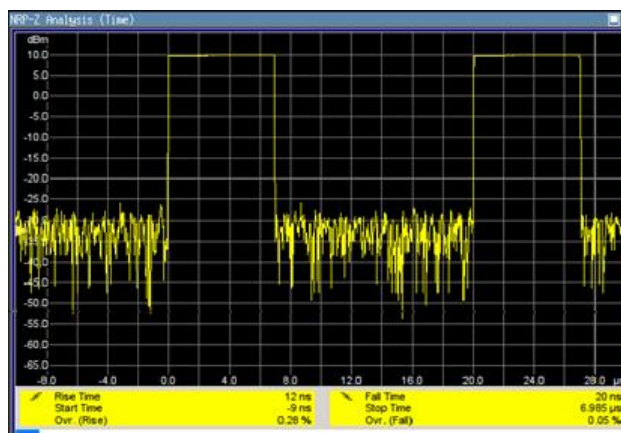
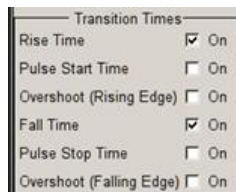

"Rise Time / Fall Time" Display the time the signal requires from crossing low reference until it reaches high reference level and vice versa.

SCPI command:

```
:TRACE<ch>[:POWER]:SWEep:MEASurement:TRANSition:POSitive:
DURation:DISPlay:ANNotation[:STATe] on page 389
```

```
:TRACe<ch>[:POWER]:SWEep:MEASurement:TRANSition:POSitive:
DURation on page 387
```

```
:TRACE<ch>[:POWER]:SWEep:MEASurement:TRANSition:NEGative:
DURation:DISPlay:ANNotation[:STATe] on page 389
```

```
:TRACe<ch>[:POWER]:SWEep:MEASurement:TRANSition:NEGative:
DURation on page 387
```

"Pulse Start Time / Pulse Stop Time" Display the time when the pulse signal crosses the medial reference level.

SCPI command:

`:TRACE<ch>[:POWer]:SWEep:MEASurement:TRANSition:POSitive:OCCurrence:DISPlay:ANNotation[:STATe]` on page 389

`:TRACe<ch>[:POWer]:SWEep:MEASurement:TRANSition:POSitive:OCCurrence` on page 387

`:TRACE<ch>[:POWer]:SWEep:MEASurement:TRANSition:NEGative:OCCurrence:DISPlay:ANNotation[:STATe]` on page 389

`:TRACe<ch>[:POWer]:SWEep:MEASurement:TRANSition:NEGative:OCCurrence` on page 387

"Overshoot (Rising Edge / Falling Edge)" Display the maximum value of the pulse signal following a rising transition and the minimum value of the signal after a falling transition, respectively.

Overshoot values are given in per cent of the pulse amplitude as shown below:

- $\text{Overshoot}(\text{pos}) = 100 \cdot (\text{maximum} - \text{top level}) / (\text{top level} - \text{base level})$
- $\text{Overshoot}(\text{neg}) = 100 \cdot (\text{base level} - \text{minimum}) / (\text{top level} - \text{base level})$

SCPI command:

`:TRACE<ch>[:POWer]:SWEep:MEASurement:TRANSition:POSitive:OVERshoot:DISPlay:ANNotation[:STATe]` on page 389

`:TRACe<ch>[:POWer]:SWEep:MEASurement:TRANSition:POSitive:OVERshoot` on page 387

`:TRACE<ch>[:POWer]:SWEep:MEASurement:TRANSition:NEGative:OVERshoot:DISPlay:ANNotation[:STATe]` on page 389

`:TRACe<ch>[:POWer]:SWEep:MEASurement:TRANSition:NEGative:OVERshoot` on page 387

Signal Power - Pulse Data Analysis

Selects the power parameters of the pulse signal to be indicated below the measurement diagram.

Note: The REARRANGE key or the key combination <STR+A> toggle between the diagram views.

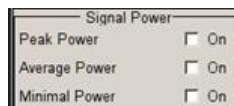

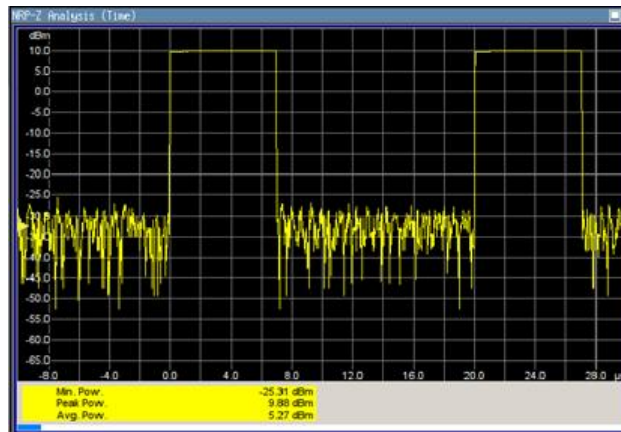

"Minimal / Peak / Average Power" display the minimum, the maximum and the average power of the pulse signal in dBm.

SCPI command:

`:TRACE<ch>[:POWER]:SWEep:MEASurement:POWer:MINimum:DISPlay:ANNOtation[:STATe]` on page 389

`:TRACe<ch>[:POWER]:SWEep:MEASurement:POWer:MINimum` on page 386

`:TRACE<ch>[:POWER]:SWEep:MEASurement:POWer:MAXimum:DISPlay:ANNOtation[:STATe]` on page 388

`:TRACe<ch>[:POWER]:SWEep:MEASurement:POWer:MAXimum` on page 386

`:TRACE<ch>[:POWER]:SWEep:MEASurement:POWer:AVERage:DISPlay:ANNOtation[:STATe]` on page 388

`:TRACe<ch>[:POWER]:SWEep:MEASurement:POWer:AVERage` on page 386

Pulse Power - Pulse Data Analysis

Selects which pulse power parameters are indicated in the diagram (pulse data view only).

Note: The "Rearrange" key or the key combination "<STR+a>" toggles between the diagram views.

Pulse Power	
Top Power	<input checked="" type="checkbox"/> On
Base Power	<input type="checkbox"/> On
Distal Power	<input type="checkbox"/> On
Mesial Power	<input type="checkbox"/> On
Proximal Power	<input type="checkbox"/> On

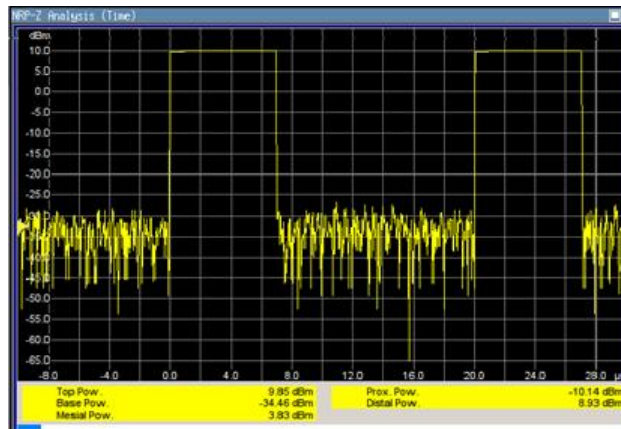

"Top / Base Power" indicate the pulse top and base level of the analyzed signal in dBm.

SCPI command:

`:TRACE<ch>[:POWER]:SWEep:MEASurement:POWer:PULSe:TOP:DISPlay:ANNOtation[:STATe]` on page 389

`:TRACe<ch>[:POWER]:SWEep:MEASurement:POWer:PULSe:TOP` on page 386

`:TRACE<ch>[:POWER]:SWEep:MEASurement:POWer:PULSe:BASE:DISPlay:ANNOtation[:STATe]` on page 388

`:TRACe<ch>[:POWER]:SWEep:MEASurement:POWer:PULSe:BASE` on page 386

"Distal / Mesial / Proximal Power" Display the absolute power values of the medial, low and high reference level in dBm.

SCPI command:

`:TRACE<ch>[:POWER]:SWEep:MEASurement:POWer:LREFerence:DISPlay:ANNOtation[:STATe]` on page 388

`:TRACe<ch>[:POWER]:SWEep:MEASurement:POWer:LREFerence` on page 386

`:TRACE<ch>[:POWER]:SWEep:MEASurement:POWer:HREFerence:DISPlay:ANNOtation[:STATe]` on page 388

`:TRACe<ch>[:POWER]:SWEep:MEASurement:POWer:HREFerence` on page 386

Diagram.. - Power Analysis

Returns to the "NRP-Z Analysis Diagram".

Configure Trigger

The "Trigger..." button opens the "Trigger NRP-Z Analysis" dialog. The button is only active for time measurement mode. For this mode, the measurement start has to be known to the sensor as the measurement is controlled by the sensor.

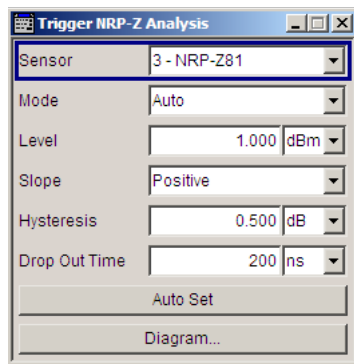

Power Sensor - Power Analysis

Selects the power sensor to be set if more than one sensor is connected to the instrument.

SCPI command:

n.a.

In remote control the sensor is selected via the numeric suffix in the sense key word of the command, e.g. `SENSe2:POWer:SWEEp:...`

Mode - Power Analysis

Selects if the measurement is free running, or starts only after an internal or external trigger event.

SCPI command:

[SENSe<ch>\[:POWer\]:SWEEp:TIME\[:SENSor\]:TRIGger:SOURce](#) on page 378

Level - Power Analysis

Sets the trigger threshold. This setting is also possible by means of the trigger marker on the left side of the diagram.

SCPI command:

[SENSe<ch>\[:POWer\]:SWEEp:TIME\[:SENSor\]:TRIGger:LEVel](#) on page 377

Hysteresis - Power Analysis

Sets the hysteresis of the internal trigger threshold. Hysteresis is the magnitude (in dB) the trigger signal level must drop below the trigger threshold (positive trigger slope) before triggering can occur again.

SCPI command:

[SENSe<ch>\[:POWer\]:SWEEp:TIME\[:SENSor\]:TRIGger:HYSTeresis](#)
on page 377

Drop out Time - Power Analysis

Determines the minimum time for which the signal must be below (above) the power level defined by "Level" and "Hysteresis" before triggering can occur again. This prevents the trigger system from being activated too early if the trigger threshold is briefly underranged or exceeded.

The dropout time parameter is useful when dealing with, for example, GSM signals with several active slots. When performing a measurement in sync with the signal, a trigger event is to be produced at A, but not at B or C. As the RF power between the slots is below the threshold defined by "Level" and "Hysteresis", the trigger hysteresis alone cannot prevent triggering at B or at C. This is why the dropout time parameter is selected to be greater than the time elapsed between points E and B and between F and C, but less than the time elapsed between G and A. This ensures that triggering will take place at A.

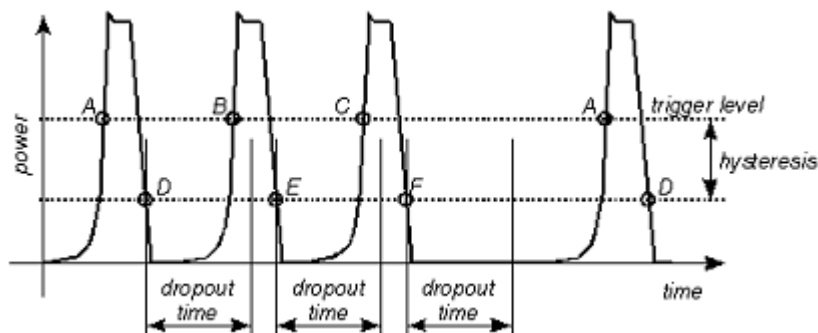

As the mechanism associated with the dropout time parameter is reactivated whenever the trigger threshold is crossed, unambiguous triggering can also be obtained for many complex signals. By contrast, all triggering is suppressed during the hold-off time. For the example described, this would mean that although stable triggering conditions could be obtained with a suitable hold-off time (regular triggering at the same point), it would not be possible to set exclusive triggering at A.

SCPI command:

[SENSe<ch>\[:POWER\]:SWEep:TIME\[:SENSor\]:TRIGger:DTIME](#) on page 377

Auto Set - Power Analysis

Sets the trigger level, the hysteresis and the drop out time to default values.

SCPI command:

[SENSe<ch>\[:POWER\]:SWEep:TIME\[:SENSor\]:TRIGger:AUTO](#) on page 376

Diagram.. - Power Analysis

Returns to the "NRP-Z Analysis Diagram".

Define Markers

Readout and comparison of particular values of the traces is possible by means of four markers. The markers can be edited either in the diagram or in the "Marker" dialog that is called with the SETUP key in the "NRP-Z Analysis" diagram.

In the "Marker" dialog, the marker can be made visible ("Visible") and assigned to a certain trace ("Trace"). The exact position still has to be defined in the diagram.



Markers and the marker list are available in the medium zoom level which is shown in the graph below. To access the markers activate the "NRP-Z Analysis (Time, Marker)" view with the "Rearrange" key. The markers are moved by means of the cursor and the roll key to the desired trace position. One click activates the marker cursor, the second click attaches the cursor to the selected marker which now can be moved to the desired position. Two clicks on the ESC key set the focus back to the diagram. The position of a active markers are indicated in the marker list.

Marker - Power Analysis

Selects the marker to be configured.

SCPI command:

n.a.

Visible - Power Analysis

Selects if the marker and the marker list is visible in the diagram.

SCPI command:

n.a.

Trace - Power Analysis

Selects the trace to which the marker is assigned.

SCPI command:

n.a.

Diagram.. - Power Analysis

Returns to the "NRP-Z Analysis" diagram.

SCPI command:

n.a.

Save Hardcopy

The "Save ..." button in the "Power Analysis" diagram opens a dialog to store a screenshot of the current measurement diagram. The current screen shot is stored as indicated, i.e. with or without marker indication. The different diagram views are toggled with the "Rearrange" key or the key combination <STR+A> on an external keyboard (see overview of features and operation in [chapter 5.4.6.2, "NRP-Z Power Analysis"](#), on page 169.

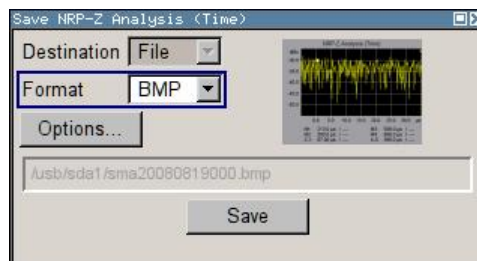

Destination - Power Analysis

Indicates that the hardcopy is stored in a file.

SCPI command:

[SENSe\[:POWER\]:SWEep:HCOPY:DEVIce](#) on page 358

Format - Power Analysis

Selects the file format.

Several bitmap graphic format are offered. In addition, format *.csv is available which stores the measurement values as ASCII data. The csv settings are performed in the "Options..." submenu.

SCPI command:

[SENSe\[:POWER\]:SWEep:HCOPY:DEVIce:LANGUage](#) on page 359

File name - Power Analysis

Indicates the file name.

The file name can be entered either manually via the file manager (button "File...") or generated automatically. Automatic naming is activated and configured in the "Options..." subdialog

SCPI command:

[SENSe\[:POWER\]:SWEep:HCOPY:FILE\[:NAME\]](#) on page 361

[SENSe\[:POWER\]:SWEep:HCOPY:FILE\[:NAME\]:AUTO:STATE](#) on page 365

[SENSe\[:POWER\]:SWEep:HCOPY:FILE\[:NAME\]:AUTO:FILE](#) on page 362

Save Hardcopy - Power Analysis

Stores the current measurement diagram as hardcopy in a graphic file format or the trace data in a csv-file, depending on the selected file format.

SCPI command:

[SENSe\[:POWER\]:SWEep:HCOPY\[:EXECute\]](#) on page 361

Save Options - Power Analysis

Opens a submenu to enter the screenshot format and size and also to activate and select the automatic naming settings.

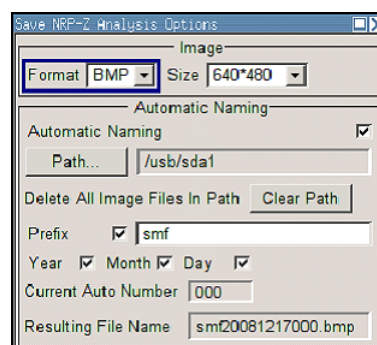

"Format" Selects the hardcopy format. In addition to several bitmap formats, format "*.csv" is available which stores the measurement values as ASCII data.

SCPI command:

`SENSe[:POWer]:SWEep:HCOPY:DEVIce:LANGUage` on page 359

"Size" Defines the size of the bitmap in terms of pixels. The first value of the size setting defines the width, the second value the height of the image.

SCPI command:

`SENSe[:POWer]:SWEep:HCOPY:DEVIce:SIZE` on page 360

"Automatic Naming" Selects that file names are created by rules if checked. The filename includes at least number and optionally additional information which is determined below.

SCPI command:

`SENSe[:POWer]:SWEep:HCOPY:FILE[:NAME]:AUTO:STATe` on page 365

"Path" Sets the directory the files are saved into. The "Clear Path" button deletes all image files with extensions "bmp", "img", "png", "xpm" and "csv" in the directory set for automatic naming.

SCPI command:

`SENSe[:POWer]:SWEep:HCOPY:FILE[:NAME]:AUTO:DIRectory` on page 362

`SENSe[:POWer]:SWEep:HCOPY:FILE[:NAME]:AUTO:DIRectory:CLEar`
on page 362

"Prefix, Year, Month, Day" "Prefix, Year, Month, Day" are included in the file name if checked and automatic naming is selected. The Auto Number used for file name creation and the resulting file name are indicated below.

SCPI command:

`SENSe[:POWer]:SWEep:HCOPY:FILE[:NAME]:AUTO[:FILE]:PREFIX:STATe`
on page 364

`SENSe[:POWer]:SWEep:HCOPY:FILE[:NAME]:AUTO[:FILE]:PREFIX`
on page 364

`SENSe[:POWer]:SWEep:HCOPY:FILE[:NAME]:AUTO[:FILE]:DAY:STATe`
on page 363

`SENSe[:POWer]:SWEep:HCOPY:FILE[:NAME]:AUTO[:FILE]:DAY` on page 363

`SENSe[:POWer]:SWEep:HCOPY:FILE[:NAME]:AUTO[:FILE]:MONTH:STATe`
on page 364

`SENSe[:POWer]:SWEep:HCOPY:FILE[:NAME]:AUTO[:FILE]:MONTH`
on page 363

`SENSe[:POWer]:SWEep:HCOPY:FILE[:NAME]:AUTO[:FILE]:YEAR:STATe`
on page 365

`SENSe[:POWer]:SWEep:HCOPY:FILE[:NAME]:AUTO[:FILE]:YEAR` on page 365

"Current Auto Number" Automatic naming only
Indicates the number which is used in the automatically generated file name.

SCPI command:

`SENSe[:POWer]:SWEep:HCOPY:FILE[:NAME]:AUTO[:FILE]:NUMBer`
on page 364

"Resulting File Name" Automatic naming only
Indicates the automatically generated file name.

SCPI command:

`SENSe[:POWer]:SWEep:HCOPY:FILE[:NAME]:AUTO:FILE` on page 362

SCPI command:

`SENSe[:POWer]:SWEep:HCOPY[:EXECute]` on page 361

CSV Options Hardcopy- Power Analysis

If file format *.csv is selected, the trace data is saved as an ASCII file with separated values. Additional settings are available in the hardcopy options submenu.

CSV files can be imported into the program MS Excel and then processed further. Adjust the value separator and the decimal point according to the language version, to import the data correctly.

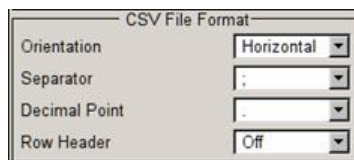

"Orientation" Defines the orientation of the X/Y value pairs:

- **Horizontal:**
X/Y values of trace 1 in rows 1 and 2,
X/Y values of trace 2 in rows 3 and 4,
X/Y values of trace 3 in rows 5 and 6,
X/Y values of trace 4 in rows 7 and 8.

Example:

Trace1,X[Hz]: 10000.0; 10010.0; 10020.0; 10030.0; ...

Trace1,Y[dBm]: -20.09; -19.17; -18.19; -15.43; ...

Trace2,X[Hz]: 10000.0; 10010.0; 10020.0; 10030.0; ...

Trace2,Y[dBm]: -19.09; -18.17; -17.19; -14.43; ...

Trace3,X[Hz]: 10000.0; 10010.0; 10020.0; 10030.0; ...

Trace3,Y[dBm]: -21.09; -20.17; -19.19; -16.43; ...

Trace4,X[Hz]: 10000.0; 10010.0; 10020.0; 10030.0; ...

Trace4,Y[dBm]: -22.07; -20.14; -21.56; -17.67; ...

- **Vertical:**

X/Y values of trace 1 in column 1 and 2,
X/Y values of trace 2 in column 3 and 4,
X/Y values of trace 3 in column 5 and 6,
X/Y values of trace 4 in column 7 and 8.

Example:

Trace1,X[Hz]; Trace1,Y[dBm]; Trace2,X[Hz]; Trace2,Y[dBm];

Trace3,X[Hz]; Trace3,Y[dBm]; Trace4,X[Hz]; Trace4,Y[dBm];

10000.0;-20.09;10000.0; -19.09;10000.0;21.09;10000.0;22.07;

10010.0;-19.17;10010.0;-18.17;10010.0; -20.17;10010.0; -20.14;

10020.0;-18.19;10020.0;-17.19;10020.0;-19.19;10020.0;-21.56;

10030.0; -15.43;10030.0; -14.43;10030.0;-16.43;10030.0;-17,67;...

SCPI command:

[SENSe\[:POWER\]:SWEep:HCOPY:DEVIce:LANGUage:CSV:ORIENTATION](#)
on page 360

"Separator" Defines which character should be used to separate the values, either tabulator, semicolon, comma or blank.

SCPI command:

[SENSe\[:POWER\]:SWEep:HCOPY:DEVIce:LANGUage:CSV\[:COLUMN\]:SEPARATOR](#)
on page 360

"Decimal Point" Defines which character should be used as the decimal point of the values, either dot or comma.

SCPI command:

[SENSe\[:POWER\]:SWEep:HCOPY:DEVIce:LANGUage:CSV:DPOINT](#) on page 359

"Row Header" Defines whether each row (or column depending on the orientation) should be preceded by a header containing information about the trace, i.e. the index of the trace and the type of value (frequency or power or time).

Example:

```
Trace=2;Source=detecting..;X[Hz];"Trace=2;Source=detecting..;Y[dBm]"
```

SCPI command:

[SENSe\[:POWer\]:SWEep:HCOPy:DEVice:LANGUage:CSV:HEADer](#) on page 359

5.4.7 User Correction

The "User Correction" function is used to create and activate lists in which level correction values predefined by the user are freely assigned to RF frequencies. Correction is performed by the user-defined table values being added to the output level for the respective RF frequency.

With frequencies which are not contained in the list, the level correction is determined by interpolation of the closest correction values.

The lists are created in the "List Editor". Each list is stored in its own file with the predefined file extension *.uco. The name of the User Correction file can be freely selected. The files are loaded from the "Lists..." file manager. Externally created tables with pairs of frequency and level values can be converted into User Correction files using the import function. The external files must have the file extension *.txt or *.csv. These file formats are provided e.g. by the Microsoft Excel program. The separators for table columns and for decimal floating-point numerals can be set. In addition, internally created User Correction data can be exported into ASCII files using the export function.

The amplitude can also be linearized automatically by means of an R&S NRP power sensor connected to one of the generator output signals. With the aid of the "Fill with Sensor" function, a table with correction values for external test assemblies can be automatically determined, e.g. for compensating the frequency response of cables. The User Correction list with the correction values acquired by the sensor is generated in the "Edit User Correction List" menu. The correction values can be acquired any time irrespective of the modulation settings of the generator.

If user correction is activated, the "UCOR" display (User Correction) is shown in the header together with the "Level" display. The RF output level is the sum of both values.

"Level" + "UCOR" = Output level

If the offset setting is used at the same time, the "Level" display value is the difference between the values entered for "Level" and "Offset" in the Level menu.

"Level" - "Offset" = Level display value

If activated, user correction is effective in all operating modes.

5.4.7.1 User Correction Menu

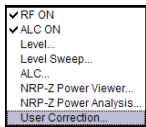

To open the "User Correction" menu, select "Level Control > Configure > User Correction" or use the MENU key under "Level Control".

The combined menu "RF Level/EMF/ALC/UCOR" is divided into the several sections.

User Correction Settings

The "User Correction" settings are set in the most lower section of the combined dialog; this section is used to activate/deactivate user correction, and to create, select and activate the lists.

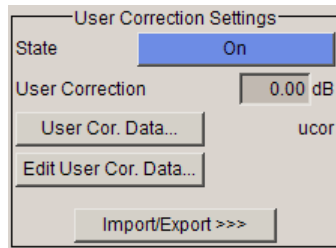

State - User Correction

Activates/deactivates user correction.

The "UCOR" status message appears in the frequency and level display.

SCPI command:

[\[:SOURce<hw>\]:CORRection\[:STATe\]](#) on page 406

User Correction Value - User Correction

Indicates the current value for level correction.

SCPI command:

[\[:SOURce<hw>\]:CORRection:VALue](#) on page 406

[\[:SOURce<hw>\]:CORRection:PMETer:TYPE](#) on page 406

Measure – User Correction

Triggers the external measurement of the user correction of the level according to the user defined frequencies.

SCPI command:

[\[:SOURce<hw>\]:CORRection:MEASure](#) on page 406

User Cor. Data - User Correction

Calls the "File Select" menu for selecting and creating a list or the "File Manager".

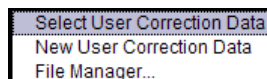

SCPI command:

[\[:SOURce\]:CORRection:CSET:DELeTe](#) on page 401

[\[:SOURce<hw>\]:CORRection:CSET\[:SELeCt\]](#) on page 405

Edit User Cor. Data - User Correction

Calls the editor for editing the selected user correction list.

A list consists of any number of frequency/level value pairs. The currently selected list is displayed.

Each list is saved as a separate file with extension *.uco. The file name and the directory to which the file is saved are user-selectable.

Note: Save list only after filling both columns (frequency and level), otherwise the entries are lost.

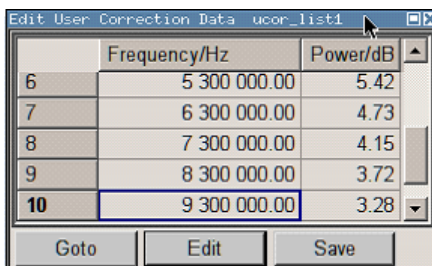

"Frequency / Hz"

Enters the frequency to which the level correction value applies.

Note: The "Fill..." function allows to automatically enter any number of frequencies with freely selectable range and increment. Using the "Fill With Sensor" function of the "Edit" sub menu requires only the entry of the frequency values. The level values are automatically acquired by the connected power sensor.

"Power/dB"

Enters the level correction value to which the specified frequency applies. The values can be entered manually or automatically with the "Fill With Sensor" function (available in the "Edit" sub menu).

"Goto"

Selects row for editing.

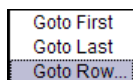

If Goto row is selected, a window opens for entering the requested row.

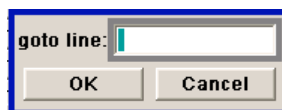

"Edit"

Calls a selection of possible actions described below.

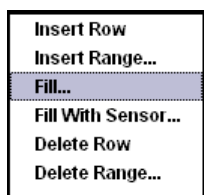

"Insert Row"

Insert a new row before the marked row.

"Insert Range" Insert new rows before the marked row. The number of rows to be inserted can be defined in an entry window.

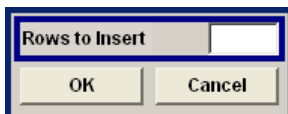

"Fill..." Opens a sub menu for defining a set of list values to be automatically entered in the ucor list (see [chapter 5.4.7.2, "Filling the Correction List automatically"](#), on page 213).

"Fill With Sensor" Calls the menu to activate the filling of the user correction list with level values acquired by the selected power sensor (see [chapter 5.4.7.3, "Filling the Correction List with Power Sensor Measurement Data"](#), on page 214).

"Delete Row" Deletes the marked row.

"Delete Range..." Allows to delete any number of rows starting with the marked row. The number of rows to be deleted can be defined in an entry window.

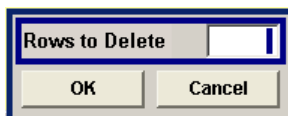

"Save as" Open the file menu to save the list under a new name.

Note: Save list only after filling both columns (frequency and level), otherwise the entries are lost.

Each list is saved to the R&S Microwave Signal Generator Compact-Flash™ Card as a separate file with the file prefix *.uco. The file name and the directory to which the file is saved are user-selectable.

"Save" The list is saved under its current name.

SCPI command:

`[:SOURce<hw>] :CORRection:CSET [:SElect]` on page 405

`[:SOURce<hw>] :CORRection:CSET:DATA:FREQuency` on page 399

`[:SOURce<hw>] :CORRection:CSET:DATA:POWer` on page 400

Import/Export

User correction list can be imported from externally created files or exported into text or CSV-files. The import/export settings are available after clicking the "Import/Export" button.

Import/Export >>>

Expands the menu with the area for import and export of user correction files.

Externally edited Excel tables with any number of frequency/level value pairs can be imported as text or CSV-files and used for user correction.

Conversely, you can also export internally created user correction lists as text or CSV-files.

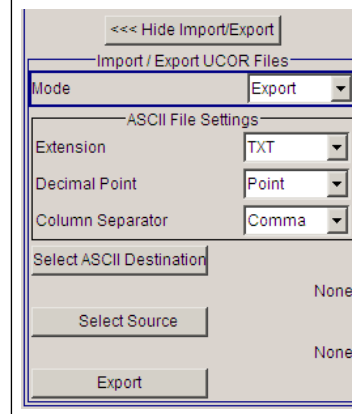
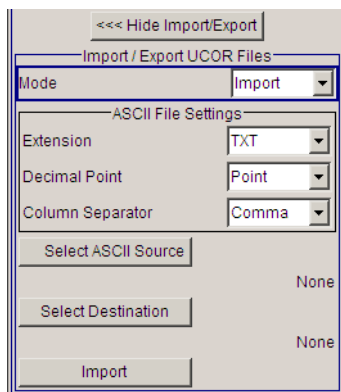

Mode - User Correction

Selects if user correction lists should be imported or exported. The settings offered depend on the selected mode.

SCPI command:

[\[:SOURce<hw>\]:CORRection:DEXChange:MODE](#) on page 404

Extension - User Correction

Selects the file extension of the ASCII file to be imported or exported. Selection "TXT" (text file) or "CSV" (Excel file) is available.

SCPI command:

[\[:SOURce<hw>\]:CORRection:DEXChange:AFILe:EXTension](#) on page 402

Decimal Point - User Correction

Selects the decimal separator used in the ASCII data between '.' (decimal point) and ',' (comma) with floating-point numerals.

SCPI command:

[\[:SOURce<hw>\]:CORRection:DEXChange:AFILe:SEParator:DECimal](#)
on page 403

Column Separator- User Correction

Selects the separator between the frequency and level column of the ASCII table the user correction list is exported to or imported from.

SCPI command:

[\[:SOURce<hw>\]:CORRection:DEXChange:AFILe:SEParator:COLumn](#)
on page 403

Select ASCII Source / Destination - User Correction

Calls the "File Manager" for selecting the ASCII file to be imported into a user correction list (source) or the ASCII file the user correction list is exported (destination) in.

SCPI command:

[\[:SOURce<hw>\]:CORRection:DEXChange:AFILe:SELeCt](#) on page 402

Destination / Source - User Correction

Calls the "File Manager" for selecting the user correction list to be exported (source) into an ASCII file or the destination for the ASCII file to be imported (destination) in.

SCPI command:

`[:SOURce<hw>] :CORRection:DEXChange:SElect` on page 405

Import / Export - User Correction

Starts the export or import of the selected file.

When import is selected, the ASCII file is imported as user correction list.

When export is selected, the user correction list is exported into the selected ASCII file.

SCPI command:

`[:SOURce<hw>] :CORRection:DEXChange:EXECute` on page 404

5.4.7.2 Filling the Correction List automatically

The "Fill Table" menu enables you to automatically set the level correction values.

The start line and the number of rows to be filled are defined under "From" and "Range."

The column to be filled is selected under "Select column to fill". Depending on the selection here, the default for start, end, and increment value are set. As the settings are interdependent, a change of one parameter may result in the automatic change of one or more of the other parameters. The filling of the column with the selected value settings is started with button "Fill".



The correction list entries are only computed when the "Fill" button is pressed.

From

Sets the start value of the index range.

SCPI command:

n.a.

Range

Sets the range for filling the table.

SCPI command:

n.a.

Select column to fill

Selects either the frequency or the level column to be filled with the value defined below.

SCPI command:

n.a.

Start value

Sets the start value for the frequency or the level entries.

SCPI command:

n.a.

End value

Displays the end value for the frequency or the level entries.

SCPI command:

n.a.

Increment value

Sets the increment for the frequency or the level entries.

SCPI command:

n.a.

Fill

Fills the selected column in the set range with values, starting with the start value and using the set increment.

SCPI command:

n.a.

5.4.7.3 Filling the Correction List with Power Sensor Measurement Data

The level correction values for the user correction list can be acquired by means of R&S NRP power sensors. The R&S NRP sensors are connected to either the SENSOR connector or to one of the USB interfaces. Configuration of the connection is performed in the "Power Sensor" menu (see [chapter 5.4.6.1, "NRP-Z Power Viewer"](#), on page 164). The filling of the ucor list with measurement data is performed in the ucor list editor (see ["Edit User Cor. Data - User Correction"](#) on page 210).

In the editor, the frequencies for which the correction values are to be acquired are entered in the frequency column (either manually or by means of the "Fill..." menu).



Do not save the list at this point, because the frequency entries are lost as long as there are no entries for the level column also. In the following these entries are automatically acquired by the connected power sensor.

All level correction values for the given frequency values are measured using the Power Sensor and automatically filled in the selected list after the "Execute" button is pressed. The list is automatically stored and recalled again after filling.

Fill User Correction Data with Sensor Settings

The "Fill with Sensor" button of the "Edit User Correction Data" menu opens the associated menu.

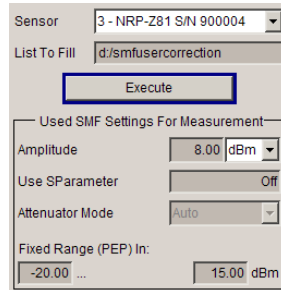

The menu indicates the relevant generator settings.

Fill User Correction Data with Sensor

All settings are read-only, except the "Sensor". In case more than one sensor is connected to the instrument, the sensor can be selected in the "Sensor" field of menu.

The "Execute" button is only enabled if a sensor is detected and the user correction list contains at least one frequency value.

SCPI command:

```
[ :SOURce<hw> ] :CORRection:CSET:DATA [ :SENSor<ch> ] [ :POWer ] :SONCe
on page 401
```

5.5 Modulations

5.5.1 Overview of Modulation

The R&S SMF provides amplitude modulation (analog and digital), frequency modulation (analog and digital), phase modulation (analog and digital), pulse modulation and chirp modulation. In addition, the RF signal can be modulated with a wide variety of internal modulations waveforms, e.g. sine waves, triangle/rectangular/trapeze signals, and noise.

Amplitude modulation (AM), frequency modulation (FM), phase modulation (PhiM), and digital modulation require option R&S SMF-B20. This option also provides two LF generators and a noise generator for internal modulation.

Narrow pulse modulation is provided by option R&S SMF-K3.

Extended pulse modulation features are provided by option R&S SMF-K23, Pulse Generator. Option R&S SMF-K27, Pulse Train, enables generation of pulse trains.

Settings for the modulation are made in separate modulation menus. These menus can be accessed in the block diagram by way of the "Modulation" function block, or by means of the menu with the same name which is opened using the MENU key.

5.5.1.1 Enabling/Disabling Analog Modulations using the MOD On/Off Key

The MOD ON/OFF key switches the modulations on and off.

MOD ON/OFF

Press the MOD ON/OFF key to enable/disable analog modulations.

Pressing the key again restores the status that was active before the last switch-off. "MOD OFF" is displayed in the info line of the header next to the "Level" field.

SCPI command:

`[:SOURce<hw>] :MODulation [:ALL] :STATe` on page 455

5.5.1.2 Modulation Sources

The following modulations use internal and external modulation sources:

- Amplitude modulation
- Pulse modulation
- Frequency modulation
- Phase modulation

Internal Modulation Sources

Two LF generators, a noise generator and a pulse generator are available as internal modulation sources for a fully equipped instrument.

The LF generators supply signals with selectable shapes (see [chapter 5.6, "LF Gen./ Noise"](#), on page 235). The pulse generator provides single and double pulse modulation with selectable pulse widths and periods or a user-definable pulse train (see [chapter 5.8, "Pulse Generator"](#), on page 255).

The noise generator supplies white noise with selectable bandwidth and level distribution.

The LF generators and the noise generator require option R&S SMF-B20. The pulse generator requires option R&S SMF-K23.

External Modulation Sources

The modulation inputs EXT 1, EXT 2, and PULSE IN at the front of the instrument are provided as the external modulation source for amplitude, frequency, phase, digital, and pulse modulation.



The external inputs EXT 1 and EXT 2 require option R&S SMF-B20.

The external modulation signal at the input must have a voltage of $U_S = 1 \text{ V}$ ($U_{EFF} = 0.707 \text{ V}$) in order to achieve the displayed modulation depth and range. The input voltage should not exceed 1.1 Vs, otherwise modulation distortions might occur. With external pulse modulation, the switching point is max. 2.4 V and the voltage at the input should not

exceed 5 V. The maximum modulation frequency is 10 MHz for frequency and phase modulation.

External Analog Modulation Sources

The external analog modulation inputs are configured in the dialogs of the selected modulation mode (amplitude modulation, frequency modulation, or phase modulation).



The following settings are valid for all analog modulation modes. Therefore, these settings are performed in all dialogs accordingly.

External Inputs		
	EXT 1	EXT 2
Coupling	AC	AC
Impedance	100 kΩ	100 kΩ
Bandwidth	10 MHz	10 MHz

Coupling – External Inputs

Selects the coupling mode (AC or DC) for external feed via the EXT 1 and/or EXT 2 input.

SCPI command:

[\[:SOURCE<hw>\]:INPUT:MODExt:COUPLing<ch>](#) on page 419

Impedance – External Inputs

Selects the impedance for external feed via the EXT 1 and/or EXT 2 input. Selection 50 Ohm, 600 Ohm, and 100 kOhm are available.

SCPI command:

[\[:SOURCE<hw>\]:INPUT:MODExt:IMPedance<ch>](#) on page 419

Bandwidth – External Inputs

Selects the bandwidth for the external feed via the EXT 1 and/or EXT 2 input. Selection 200 kHz und 10 MHz are available.

SCPI command:

[\[:SOURCE\]:LFOutput<ch>:BANDwidth](#) on page 422

External Digital Modulation Sources

The external digital modulation inputs are configured in the "Digital Modulation" dialog.



The settings are valid for all digital modulation modes (ASK, FSK, PSK).

External Inputs	
EXT 1 Impedance	100 kΩ
EXT 2 Impedance	100 kΩ
EXT 1 Polarity	Normal
EXT 2 Polarity	Normal

EXT 1/2 Impedance – External Inputs

Selects the impedance for external feed via the EXT 1 and/or EXT 2 input. Selection 50 Ohm, 600 Ohm, and 100 kOhm are available.

SCPI command:

[:SOURce<hw>] :INPut:MODext:IMPedance<ch> on page 419

Polarity – External Inputs

Sets the polarity of the external modulation signal.

"Normal" The RF level is **ON** while the level is **HIGH**.

"Inverse" The RF level is **ON** while the level is **LOW**.

SCPI command:

[:SOURce<hw>] :DM:EXTernal:POLarity<ch> on page 408

Simultaneous Operation of Several Modulations or Other Operating Modes

The table shows the modulations and operating modes which can be activated simultaneously (+) or which deactivate each other (-).

	AM	ASK	FM	FSK	PhiM	PSK	PuM
Amplitude modulation (AM)	/	+	+	+	+	+	+
ASK	-	/	+	+	+	+	-
Frequency modulation (FM)	+	+	/	-	-	-	+
FSK	+	+	-	/	-	+	+
Phase modulation (PhiM)	+	+	-	-	/	-	+
PSK	+	+	-	-	-	/	+
Pulse modulation (PuM)	+	-	+	-	+	+	/

5.5.2 Amplitude Modulation (AM)

An internal and/or external source can be selected for amplitude modulation. Two LF modulation generators and a noise generator are available as the internal source for a fully equipped instrument. Two-tone AM is possible by simultaneously switching on the external and internal or both internal sources.

Two external input connectors for external feed of analog modulation signals are located on the front panel of the instrument.

The AM modulation depth is limited by the maximum peak envelope power (PEP).

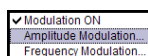
5.5.2.1 Amplitude Modulation Menu

To open the "Amplitude Modulation" menu, select "Modulation > Configure > Amplitude Modulation" or use the MENU key under "Modulation".

For a fully equipped instrument two LF generators and a noise generator are available as internal sources.

In the upper section of the menu, the amplitude modulation is activated and configured. Additionally, the scan state and the ratio can be set. In the "External Inputs" section, the external inputs are configured. These settings affect all modulations which use the same external modulation sources. For a detailed description, see "[External Analog Modulation Sources](#)" on page 217. The "LF Frequency" field displays the LF frequency as adjusted in the "LF Generator" menu. This value can be also be changed.

The screenshot shows the AM Modulation menu with the following settings:

- Path 1:** State: On; Source: LF Generator 1; Depth: 30.00 %
- Path 2:** State: Off; Source: LF Generator 2; Depth: 30.00 %
- Scan Modulation:** Scan State: Off; Ratio: 100.00 %
- LF Generators:**
 - Gen 1:** Shape: Sine; Frequency: 1.000 0 kHz; Period: 1.000 00 ms
 - Gen 2:** Shape: Sine; Frequency: 1.000 0 kHz; Period: 1.000 00 ms
- External Inputs:**
 - EXT 1:** Coupling: AC; Impedance: 100 kΩ; Bandwidth: 10 MHz
 - EXT 2:** Coupling: AC; Impedance: 100 kΩ; Bandwidth: 10 MHz

State

Activates/deactivates AM modulation.

SCPI command:

[\[:SOURce<hw>\]:AM<ch>:STATe](#) on page 394

Source

Selects the source for the AM signal.

"LF Generator 1/2" Selects the internal LF generator (either 1 or 2) as the source for AM modulation.

"Ext 1/2" Selects the external source (either EXT 1 or EXT 2) as the source for amplitude modulation.

"Noise Generator" Selects the internal noise generator.

SCPI command:

[\[:SOURce<hw>\]:AM<ch>:SOURce](#) on page 393

AM Depth

Sets the modulation depth in percent.

Note: This function is available when scanning state is off.

With two-tone modulation, observe that the set modulation depth is valid for both signals and the sum modulation depth is determined by doubling the set modulation depth. This results in overmodulation if the maximal value for modulation depth is exceeded (see data sheet).

SCPI command:

[\[:SOURce<hw>\]:AM<ch>\[:DEPTh\]](#) on page 392

AM Sensitivity

Sets the input sensitivity of the EXT 1/2 input in db/V.

Note: This function is available when scanning state is on.

SCPI command:

[\[:SOURce<hw>\]:AM<ch>:SENSitivity](#) on page 393

Scan State – Amplitude Modulation

Activates/deactivates the logarithmic amplitude modulation.

SCPI command:

[\[:SOURce<hw>\]:AM:SCAN:STATe](#) on page 393

Ratio – Amplitude Modulation

Sets the path1/path 2 ratio.

SCPI command:

[\[:SOURce<hw>\]:AM:RATio](#) on page 392

LF Gen Shape

Selects the waveform shape of the LF signal.

SCPI command:

[\[:SOURce\]:LFOutput<ch>:SHAPE](#) on page 436

Frequency – LF Generator

The frequency of the LF generator 1/2.

This setting affects all analog modulations which use the LF generator as the internal modulation source.

It depends on the used shape:

- "Sine"
Sets the repetition frequency of the internal signal. In this case the signal period results from this value, indicated in [Period](#).
- "Pulse, Triangle or Trapezoid "
Indicates the frequency resulting from the set signal [Period](#).

SCPI command:

[\[:SOURce\]:LFOutput<ch>:FREQuency](#) on page 422

Period (Sine Shape) – LF Generator

Indicates the period of the LF sine signal. It is determined by the repetition frequency of the internal signal, see [Frequency](#).

Period (Pulse, Triangle, Trapezoid Shape) – LF Generator

Sets the period of the current LF signal. The period determines the repetition frequency of the internal signal, see [Frequency](#).

SCPI command:

[\[:SOURce\]:LFOutput<ch>:SHAPE:PULSe:PERiod](#) on page 436

[\[:SOURce\]:LFOutput<ch>:SHAPE:TRAPeZe:PERiod](#) on page 437

[\[:SOURce\]:LFOutput<ch>:SHAPE:TRIangle:PERiod](#) on page 438

5.5.3 Frequency Modulation (FM)



Frequency modulation requires option R&S SMF-B20 (AM/FM/PhiM/Log AM Modulator).

An internal and/or external source can be selected for frequency modulation. Two LF modulation generators and a noise generator are available as internal sources for a fully equipped instrument. Two-tone FM is possible by simultaneously switching on the external and internal source.

Two external input connectors for external feed of analog modulation signals are located on the front panel of the instrument.



It is not possible to use analog frequency modulation simultaneously with digital frequency modulation or with analog or digital phase modulation.

5.5.3.1 Frequency Modulation Settings

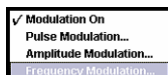

To open the "Frequency Modulation" menu, select "Modulation > Configure > Frequency Modulation" or use the MENU key under "Modulation".

For a fully equipped instrument two LF generators and a noise generator are available as internal sources.

	Path 1	Path 2
State	On	Off
Source	LF Generator 1	LF Generator 2
Deviation	10.000 kHz	10.000 kHz
Ratio FM 2/1	100.00 %	
Mode	Normal	
LF Generators		
	Gen 1	Gen 2
Shape	Sine	Triangle
Frequency	2.000 0 kHz	1.000 00 kHz
Period	500.00 µs	1.000 00 ms
External Inputs		
	EKT 1	EKT 2
Coupling	AC	AC
Impedance	100 kΩ	100 kΩ
Bandwidth	10 MHz	10 MHz

In the upper section of the menu, the frequency modulation is activated and configured. Then, the frequency ratio FM path2/path1 and the modulation mode are selected. The "LF Generators" section sets the parameters of the LF generators 1/2. These settings affect all analog modulations which use the LF generator as the internal modulation source.

In the "External Inputs" section, the external inputs are configured. These settings affect all modulations which use the same external modulation sources. For a detailed description, see section "[External Analog Modulation Sources](#)" on page 217.

State

Activates/deactivates FM modulation.

Activation of FM deactivates phase modulation.

SCPI command:

`[:SOURce<hw>] :FM<ch> :STATe` on page 412

Source (Frequency Modulation)

Selects the source for the FM signal.

"LF Generator 1/2" Selects the internal LF generator (either 1 or 2) as the source for frequency modulation.

"EXT 1/2" Selects the external input (either EXT 1 or EXT 2) as the source for frequency modulation.

"Noise Generator" Selects the internal noise generator as source for frequency modulation.

SCPI command:

`[:SOURce<hw>] :FM<ch> :SOURce` on page 412

FM Deviation

Sets the modulation deviation in Hz.

The maximal deviation depends on the RF frequency set and the selected modulation mode (see data sheet). It is possible to enter a deviation that is too high for a certain RF frequency or to vary the RF frequency to a range in which the deviation can no longer be set. In this case the maximally possible deviation is set and an error message is displayed.

The deviation of the internal source must not exceed the deviation of the external source.

SCPI command:

`[:SOURce<hw>] :FM<ch> [:DEViation]` on page 411

Ratio FM 2/1

Sets the deviation of path2/deviation of path 1 ratio.

For example, if the ratio is set to 50%, the deviation of path 2 will become 5 kHz if the deviation of path 1 is set to 10 kHz.

SCPI command:

`[:SOURce<hw>] :FM:RATio` on page 411

Mode (Frequency Modulation)

Selects the mode for the frequency modulation.

"Normal" The maximum range for modulation bandwidth and FM deviation is available.

"Low Noise" Frequency modulation with phase noise and spurious characteristics close to CW mode. The range for modulation bandwidth and FM deviation is reduced (see data sheet).

SCPI command:

`[:SOURce<hw>] :FM:MODE` on page 411

LF Gen Shape

Selects the waveform shape of the LF signal.

SCPI command:

[\[:SOURce\]:LFOutput<ch>:SHAPE](#) on page 436

Frequency – LF Generator

The frequency of the LF generator 1/2.

This setting affects all analog modulations which use the LF generator as the internal modulation source.

It depends on the used shape:

- "Sine"
 - Sets the repetition frequency of the internal signal. In this case the signal period results from this value, indicated in [Period](#).
- "Pulse, Triangle or Trapezoid "
 - Indicates the frequency resulting from the set signal [Period](#).

SCPI command:

[\[:SOURce\]:LFOutput<ch>:FREQUENCY](#) on page 422

Period (Sine Shape) – LF Generator

Indicates the period of the LF sine signal. It is determined by the repetition frequency of the internal signal, see [Frequency](#).

Period (Pulse, Triangle, Trapezoid Shape) – LF Generator

Sets the period of the current LF signal. The period determines the repetition frequency of the internal signal, see [Frequency](#).

SCPI command:

[\[:SOURce\]:LFOutput<ch>:SHAPE:PULSE:PERIOD](#) on page 436

[\[:SOURce\]:LFOutput<ch>:SHAPE:TRAPEZE:PERIOD](#) on page 437

[\[:SOURce\]:LFOutput<ch>:SHAPE:TRIANGLE:PERIOD](#) on page 438

5.5.4 Phase Modulation (PhiM)

Frequency modulation requires option R&S SMF-B20 (AM/FM/PhiM/Log AM Modulator).



It is not possible to use analog phase modulation simultaneously with digital phase modulation or with analog or digital frequency modulation.

An internal and/or external source can be selected for phase modulation. Two LF modulation generators and a noise source are available as internal sources for a fully equipped instrument.

Two-tone PhiM is possible by simultaneously switching on the external and internal or both internal sources. Two external input connectors for external feed of analog modulation signals are located on the front panel of the instrument.

5.5.4.1 Phase Modulation Menu

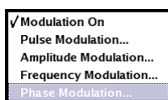

To open the "Phase Modulation" menu, select "Modulation > Configure > Phase Modulation" or use the MENU key under "Modulation".

Path 1		Path 2	
State	On	Off	
Source	LF Generator 1	LF Generator 2	
Deviation	1.000 0 rad	1.000 0 rad	
Ratio PM 2/1			100.00 %
Mode			High Bandwidth
LF Generators			
Gen 1		Gen 2	
Shape	Sine	Triangle	
Frequency	2.000 0 kHz	1.000 00 kHz	
Period	500.00 µs	1.000 00 ms	
External Inputs			
EXT 1		EXT 2	
Coupling	AC	AC	
Impedance	100 kΩ	100 kΩ	
Bandwidth	10 MHz	10 MHz	

For a fully equipped instrument two LF generators and a noise generator are available as internal sources.

In the upper section of the menu, the phase modulation is activated and configured. Then, the phase modulation ratio and the modulation mode are selected. The "LF Generators" section covers the frequency fields of the two LF generators (1/2). This setting affects all analog modulations which use the LF generator as the internal modulation source.

In the "External Inputs" section, the external inputs are configured. These settings affect all modulations which use the same external modulation sources. For a detailed description, see section ["External Analog Modulation Sources"](#) on page 217.

State

Activates/deactivates PhiM modulation.

Activation of PhiM deactivates frequency modulation.

SCPI command:

[\[:SOURce<hw>\]:PM<ch>:STATe](#) on page 460

Source – Phase Modulation

Selects the source for the phase modulation signal.

"LF Generator 1/2" Selects the internal LF generator (either 1 or 2) as the source for phase modulation.

"EXT 1/2" Selects the external input (either EXT 1 or EXT 2) as the source for phase modulation.

"Noise Generator" Selects the internal noise generator as source for phase modulation.

SCPI command:

[\[:SOURce<hw>\]:PM<ch>:SOURce](#) on page 459

Ratio PM 2/1 – Phase Modulation

Sets the deviation of path 2/deviation of path 1 ratio.

For example, if the ratio is set to 50%, the deviation of path 2 will become 5 kHz if the deviation of path 1 is set to 10 kHz.

SCPI command:

`[:SOURce<hw>] :PM:RATio` on page 459

PhiM Mode

Selects the mode for the phase modulation.

"High Bandwidth"	The maximum range for modulation bandwidth is available. However, phase noise is increased for low frequencies. The range for PhiM deviation is limited. This mode is recommended for high modulation frequencies.
"High Deviation"	The maximum range for PhiM deviation is available. Phase noise is improved for low frequencies compared to the default mode. The range for modulation frequency is limited (see data sheet). This mode is recommended for low modulation frequencies and/or high PhiM deviation.
"Low Noise"	Phase modulation with phase noise and spurious characteristics close to CW mode. The range for modulation bandwidth and PM deviation is reduced (see data sheet).

SCPI command:

`[:SOURce<hw>] :PM:MODE` on page 458

PhiM Deviation

Sets the modulation depth in RAD or degrees.

The maximal deviation depends on the RF frequency set and the selected modulation mode (see data sheet). It is possible to enter a deviation that is too high for a certain RF frequency or to vary the RF frequency to a range in which the deviation can no longer be set. In this case the maximally possible deviation is set and an error message is displayed.

SCPI command:

`[:SOURce] :PM<ch>[:DEVIation]` on page 458

LF Gen Shape

Selects the waveform shape of the LF signal.

SCPI command:

`[:SOURce] :LFOutput<ch>:SHAPE` on page 436

Frequency – LF Generator

The frequency of the LF generator 1/2.

This setting affects all analog modulations which use the LF generator as the internal modulation source.

It depends on the used shape:

- "Sine"
Sets the repetition frequency of the internal signal. In this case the signal period results from this value, indicated in [Period](#).

- "Pulse, Triangle or Trapezoid "
Indicates the frequency resulting from the set signal [Period](#).

SCPI command:

[\[:SOURce\]:LFOutput<ch>:FREQuency](#) on page 422

Period (Sine Shape) – LF Generator

Indicates the period of the LF sine signal. It is determined by the repetition frequency of the internal signal, see [Frequency](#).

Period (Pulse, Triangle, Trapezoid Shape) – LF Generator

Sets the period of the current LF signal. The period determines the repetition frequency of the internal signal, see [Frequency](#).

SCPI command:

[\[:SOURce\]:LFOutput<ch>:SHAPE:PULSE:PERiod](#) on page 436

[\[:SOURce\]:LFOutput<ch>:SHAPE:TRAPeZe:PERiod](#) on page 437

[\[:SOURce\]:LFOutput<ch>:SHAPE:TRIangle:PERiod](#) on page 438

5.5.5 Digital Modulation

An internal and/or external source can be selected for digital modulation. The internal pulse generator source is available as internal source for a fully equipped instrument.

Two external input connectors for external feed of digital modulation signals are located on the front panel of the instrument.



This modulation mode requires option R&S SMF-B20.

Activating a digital modulation mode can deactivate another digital or analog modulation modes. For an overview about the operating modes which operate simultaneously, see "[Simultaneous Operation of Several Modulations or Other Operating Modes](#)" on page 218.

5.5.5.1 Digital Modulation Menu

To open the "Phase Modulation" menu, select "Modulation > Configure > Phase Modulation" or use the MENU key under "Modulation".

The screenshot shows a configuration dialog for modulation. On the left, a vertical menu has 'Modulation On' selected. The main dialog is divided into four sections: ASK, FSK, PSK, and External Inputs. Each section has a 'State' button, a 'Source' dropdown, and a 'Deviation' or 'Depth' field. The ASK section is active, showing 'On' state, 'EXT 1' source, and '30.00 %' depth. The FSK section shows 'On' state, 'EXT 1' source, and '10.000 kHz' deviation. The PSK section shows 'Off' state, 'EXT 1' source, and '1.0 rad' deviation. The External Inputs section has four dropdowns: EXT 1 Impedance (100 kΩ), EXT 2 Impedance (100 kΩ), EXT 1 Polarity (Normal), and EXT 2 Polarity (Normal).

The combined dialog provides selection between the following modulation modes:

- In the "ASK" section, the modulation signal of type ASK (amplitude shift keying) is configured.
- In the "FSK" section, the modulation signal of type FSK (frequency shift keying) is configured.
- In the "PSK" section, the modulation signal of type PSK (phase shift keying) is configured.
- In the "External Inputs" section, the impedance and polarity of the external inputs EXT 1 and/or EXT 2 are configured. These settings affect all modulations which use the same external modulation sources. For a detailed description, see ["External Analog Modulation Sources"](#) on page 217.

State – ASK

Activates/deactivates ASK modulation.

SCPI command:

`[:SOURce<hw>] :DM:ASK:STATe` on page 408

Source – ASK

Selects the source for the ASK modulation signal.

"EXT 1/2" Selects the external inputs (either EXT 1 or EXT 2) as the source for ASK modulation.

"Pulse Generator" Selects the internal pulse generator as source for ASK modulation.

"Random" Selects random pulses generated by the noise generator as the source for ASK modulation.

SCPI command:

`[:SOURce<hw>] :DM:ASK:SOURce` on page 407

Depth – ASK

Sets the modulation depth for ASK modulation.

SCPI command:

[\[:SOURce<hw>\]:DM:ASK:DEPTh](#) on page 407

State – FSK

Activates/deactivates FSK modulation.

SCPI command:

[\[:SOURce<hw>\]:DM:FSK:STATe](#) on page 409

Source – FSK

Selects the source for the FSK modulation signal.

"EXT 1/2" Selects the external inputs (either EXT 1 or EXT 2) as the source for FSK modulation.

"Pulse Genera- Selects the internal pulse generator as source for FSK modulation.
tor"

"Random" Selects random pulses generated by the noise generator as the source for FSK modulation.

SCPI command:

[\[:SOURce<hw>\]:DM:FSK:SOURce](#) on page 408

Deviation – FSK

Sets the frequency deviation for FSK modulation.

SCPI command:

[\[:SOURce<hw>\]:DM:FSK:DEVIation](#) on page 408

State – PSK

Activates/deactivates PSK modulation.

SCPI command:

[\[:SOURce<hw>\]:DM:PSK:STATe](#) on page 410

Source – PSK

Selects the source for the PSK modulation signal.

"EXT 1/2" Selects the external inputs (either EXT 1 or EXT 2) as the source for PSK modulation.

"Pulse Genera- Selects the internal pulse generator as source for PSK modulation.
tor"

"Random" Selects random pulses generated by the noise generator as the source for PSK modulation.

SCPI command:

[\[:SOURce<hw>\]:DM:PSK:SOURce](#) on page 409

Deviation – PSK

Sets the frequency deviation for PSK modulation.

SCPI command:

`[:SOURce<hw>] :DM:PSK:DEVIation` on page 409

5.5.6 Pulse Modulation (PM)

External and internal pulse modulation is available for the basic unit of the R&S SMF equipped with the pulse modulation options.

The external signal is input via the PULSE IN connector at the front of the instrument. The connector can be used as trigger input for internal pulse modulation. The external pulse signal is output at the VIDEO connector at the back of the instrument.

Narrow pulse modulation is provided by option R&S SMF-K3. Internal pulse modulation with extended features, e.g. generation of double pulse, requires option R&S SMF-K23, Pulse Generator. The generation of a pulse train requires option R&S SMF-K27.

The pulse signal is output at the PULSE OUT connector at the front of the instrument.

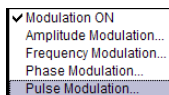

It is not possible to use pulse modulation simultaneously with digital amplitude modulation or with digital frequency modulation.

5.5.6.1 Pulse Modulation Settings

To open the "Pulse Modulation" menu, select "Modulation > Configure > Pulse Modulation", or select "Pulse Mod > Configure > Pulse Modulation", or use the MENU key under "Modulation".

In the upper section of the menu, the modulation source is selected and the modulation switched on. The configuration of the selected external and/or internal modulation source is performed in the lower section of the menu.

The menu varies according to the selected modulation source.

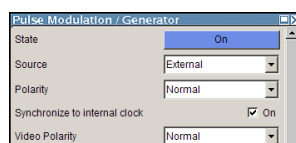

In case of modulation source pulse generator, the settings for the pulse characteristics and the trigger are offered in the "Pulse Generator" section of the "Pulse Modulation" dialog. Option R&S SMF-K23 offers extended features, e.g. generation of double pulse or selection of trigger mode. For description of the pulse generator dialog, see [chapter 5.8, "Pulse Generator"](#), on page 255.

Pulse Generator	
Pulse Mode	Double
Pulse Period	10.000 μ s
Pulse Width	2.000 μ s
Double Pulse Width	3.000 μ s
Double Pulse Delay	3.000 μ s
Pulse Output State	<input type="checkbox"/> On
Pulse Output Polarity	Normal
Input/Trigger Settings	
Trigger Mode	Auto
Trigger Level	TTL
Ext Trigger Input Slope	Positive
Gate Input Polarity	Normal
External Impedance	50 Ω

Option R&S SMF-K27 enables the generation of pulse trains. For description of the pulse train dialog, see [chapter 5.8.2, "Pulse Train Generation"](#), on page 259.

In the "Input/Trigger Settings" section, the external input and trigger are configured.

State

Activates/deactivates pulse modulation.

If modulation source Pulse Generator is selected (requires option R&S SMF-K23), the pulse generator is switched on/off, in addition.

When the internal modulation source (pulse generator) is selected, the pulse generator is switched on automatically and the video/sync signal is output at the PULSE VIDEO output at the rear of the instrument. Signal output can be switched off in the "Pulse Generator" dialog (see [chapter 5.8, "Pulse Generator"](#), on page 255).

SCPI command:

[:SOURce<hw>] :PULM:STATe on page 473

Source

Selects the source for the pulse modulation signal.

"Pulse Generator" Selects the Pulse Generator as modulation source. The internal pulse generator signal is provided at the PULSE OUT output.

- Without option R&S SMF-K23:
The internally generated rectangular signal is used for the pulse modulation. The frequency of the internal signal can be set in the LF Output menu.
- With option R&S SMF-K23:
If option R&S SMF-K23 is installed, the characteristics of the generated pulse can be set in a wide range, and double pulse generation is possible. The settings are made in the "Pulse Generator" section of the menu.

"External" Selects the external source. The external modulation signal is input via the PULSE IN connector.

"Random" Selects random pulses generated by the noise generator as the source for pulse modulation.

SCPI command:

[\[:SOURce<hw>\]:PULM:SOURce](#) on page 473

Polarity

(External Source only)

Selects the polarity of the modulation signal.

"Normal" The RF signal is **On** while the level is high at the modulation input.

"Inverted" The RF level is ON while the level is LOW at the modulation input.

SCPI command:

[\[:SOURce<hw>\]:PULM:POLarity](#) on page 472

Synchronize to internal clock - Pulse Modulation

(External Source only)

When enabled, the external modulation signal is synchronized to the internal 200 MHz reference before it is passed to the pulse modulator. Since most instrument capabilities are timed by the same reference, the edges of the modulation signal can be synchronized e.g. to RF or to pulse modulator outputs if instrument is set up accordingly.

When disabled, the signal is passed asynchronously to the modulator.

SCPI command:

[\[:SOURce<hw>\]:PULM:SYNC](#) on page 473

Video Polarity - Pulse Modulation

Selects the polarity of the pulse video output.

"Normal" The video signal level is HIGH while the RF level is ON.

"Inverse" The video signal level is LOW while the RF level is ON.

SCPI command:

[\[:SOURce<hw>\]:PULM:OUTPut:VIDeo:POLarity](#) on page 471

5.5.7 Chirp Modulation

Chirp modulation is used in radar technique to achieve pulse compression. Pulse compression increases the sensitivity and resolution of radar systems by modifying transmitted pulses to improve their auto-correlation properties. To chirp the radar signal is one way of accomplishing this. A chirp is a signal in which the frequency increases or decreases over time.

The R&S SMF always uses chirp modulation together with pulse modulation. The modulation signals for FM and Pulse modulator are generated and synchronized internally. The internal pulse generator is used as the modulation source for the pulse modulator and the internal LF generator as source for the frequency modulation. Normal FM mode is used. Using external modulation signals is not possible for chirp modulation.

The following graph shows the FM demodulated signal of chirped pulses with a chirp bandwidth of 80 MHz and a pulse width of 80 us. Chirp direction is up.

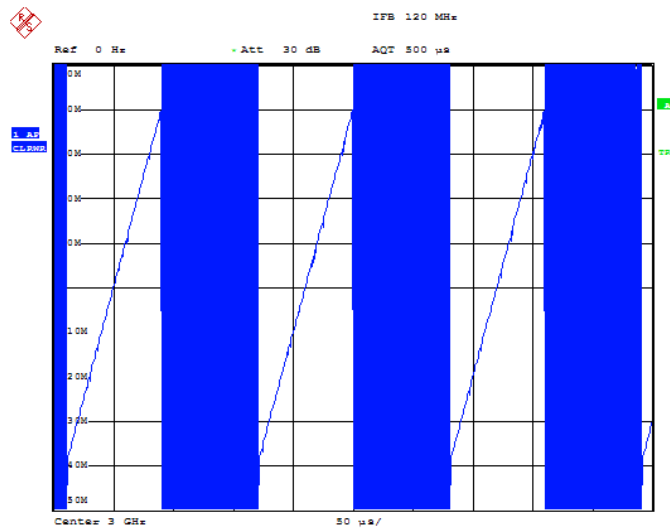

Date: 10.MAR.2008 15:38:01

Chirp modulation is available for the basic unit (R&S SMF + frequency option R&S SMF-B10x) equipped with option R&S SMF-B20 (AM/FM/PHIM/LOG AM Modulator), R&S SMF-K3 (Narrow Pulse Modulator) and R&S SMF-K23 (Pulse Generator).

The PULSE IN connector at the rear of the instrument this connector can be used as external trigger or gate signal input.

The polarity and input impedance of the connector can be selected.

The pulse signal is output at the PULSE OUT connector at the rear of the instrument, the sync signal at the SYNC output.

The FM modulation signal can be output at the LF connector.



All other analog modulations are deactivated during chirp modulation!

When chirp modulation is activated, any active analog modulation is automatically switched off.



The Sample&Hold measurement for the ALC is performed at the chirp center frequency. Therefore, the frequency response of the RF path may result in level errors for the FM modulated carrier especially with high chirp bandwidths.

5.5.7.1 Chirp Modulation Settings



The "Chirp modulation" dialog is opened in the "Modulation" function block or using the MENU key under "Modulation".

In the upper section of the menu, the modulation is configured and switched on. The configuration of the trigger source is performed in the lower section of the menu.

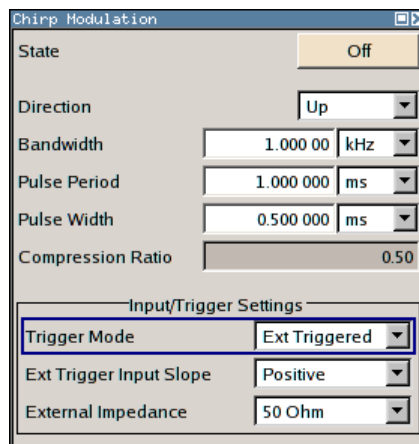

State - Chirp Modulation

Activates/deactivates chirp modulation

Note: Any active modulation is automatically switched off when chirp modulation is activated.

The pulse generator signal is provided at the "PULSE OUT" output, the sync signal at the "SYNC" output.

These outputs are automatically switched on/off according to the chirp modulation state. The FM modulation signal can be output at the LF connector.

SCPI command:

[:SOURce<hw>] :CHIRp:STATe on page 396

Direction - Chirp Modulation

Selects the direction of the chirp modulation.

"Up" The chirp starts with the lower frequency.

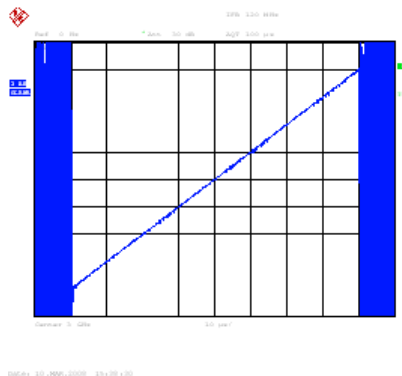

"Down"

The chirp starts with the higher frequency.

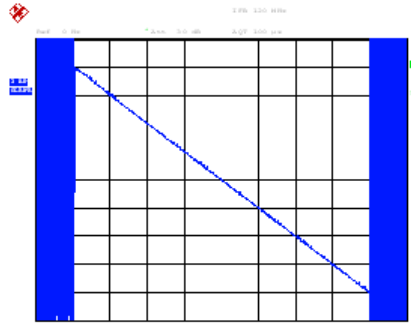

SCPI command:

[\[:SOURce<hw>\]:CHIRp:DIRection](#) on page 395

Bandwidth - Chirp Modulation

Sets the modulation bandwidth in Hz.

The bandwidth denotes the difference between the maximum and minimum frequency, e.g. a bandwidth of 10 MHz at a center frequency of 1 GHz leads to a frequency modulation between 995 MHz and 1005 MHz.

The maximum bandwidth depends on the currently set RF frequency (see data sheet). It is possible to enter a bandwidth that is too high for a certain RF frequency or to vary the RF frequency to a range in which the bandwidth can no longer be set. In this case the maximum possible bandwidth is set and an error message is displayed.

SCPI command:

[\[:SOURce<hw>\]:CHIRp:BANDwidth](#) on page 394

Pulse Period - Chirp Modulation

Sets the period of the generated chirp. Option R&S SMF-K23 provides a resolution of 20 ns.

SCPI command:

[\[:SOURce<hw>\]:CHIRp:PULSe:PERiod](#) on page 395

Pulse Width - Chirp Modulation

Sets the width of the generated chirp. The pulse width must be at least 1 us less than the set pulse period. Option R&S SMF-K23 provides a resolution of 20 ns.

SCPI command:

[\[:SOURce<hw>\]:CHIRp:PULSe:WIDTh](#) on page 395

Compression Ratio - Chirp Modulation

Indicates the pulse compression ratio, i.e. the product of pulse width [s] and bandwidth [Hz]. Pulse compression increases the range resolution as well as the signal to noise ratio of pulsed signals.

SCPI command:

[\[:SOURce<hw>\]:CHIRp:COMPression:RATio](#) on page 395

Trigger Mode - Chirp Modulation

Selects the trigger mode for chirp modulation signals.

Note: An external trigger signal is supplied via the PULSE IN connector.

"Auto" The chirp modulation signals are generated continuously.

"Ext Single" The chirp modulation signals are triggered by an external trigger event.

"Ext Gated" The chirp modulation signals are gated by an external gate signal.

SCPI command:

[\[:SOURce<hw>\]:CHIRp:TRIGger:MODE](#) on page 397

Trigger Level – Chirp Modulation

Selects the external trigger level (threshold TTL, 0.5 V or -2.5 V).

SCPI command:

[\[:SOURce<hw>\]:CHIRp:TRIGger:EXTernal:LEVel](#) on page 397

External Trigger Input Slope - Chirp Modulation

Sets the polarity of the active slope of an applied trigger signal.

Note: An external trigger signal is supplied via the PULSE IN connector.

"Positive" The chirp modulation signals are triggered on the positive slope of the external trigger signal.

"Negative" The chirp modulation signals are triggered on the negative slope of the external trigger signal.

SCPI command:

[\[:SOURce<hw>\]:CHIRp:TRIGger:EXTernal:SLOPe](#) on page 397

Gate Input Polarity - Chirp Modulation

Selects the polarity of the Gate signal.

Note: An external gate signal is supplied via the PULSE IN connector.

"Normal" The chirp modulation signals are generated while the gate signal is high.

"Inverse" The chirp modulation signals are generated while the gate signal is low.

SCPI command:

[\[:SOURce<hw>\]:CHIRp:TRIGger:EXTernal:GATE:POLarity](#) on page 396

External Impedance - Chirp Modulation

Selects the input impedance for the external trigger and gate signal input (10 kOhm or 50 Ohm).

SCPI command:

[\[:SOURce<hw>\]:CHIRp:TRIGger:EXTernal:IMPedance](#) on page 396

5.6 LF Gen./Noise

The "LF Gen./Noise" block provides two internal LF generators which can be used as internal modulation sources for analog modulations (amplitude modulation, frequency

modulation, phase modulation) and a noise generator. The LF/Noise generators can also be used as the signal source for the LF output at the front of the instrument.



The internal LF/Noise generators require option R&S SMF-B20.

Both LF generators providing sinusoidal signals in the frequency range 0.1 Hz to 10 MHz with selectable signal shapes e.g. sine waves, triangle/ pulse/ trapezoid signals.

The LF frequency settings for the LF generator can be made in the LF Gen./Noise menu, LF Output menu, and analog modulation menus.

A change to the frequency of the LF generator automatically has an effect on modulation if the LF generator is selected as the modulation source. For example, a change to the frequency of the first LF generator automatically has an effect on the amplitude modulation if the first LF generator is selected as the AM modulation source (i.e. LF Generator 1 is selected as Source). On the other hand, changing the frequency in the Amplitude Modulation menu has an effect to the LF output signal.

The LF frequency sweep mode is activated in the LF Frequency Sweep menu. The LF level sweep is activated in the LF Level Sweep menu of the "LF Output" block.

The Noise generator supplies noise with selectable bandwidth and level distribution.

The LF frequency sweep mode is activated in the "LF Frequency Sweep" dialog of the "LF Gen./Noise" block (see [chapter 5.6.3, "LF Frequency Sweep"](#), on page 239). The LF level sweep is activated in the "LF Level Sweep" dialog of the "LF Output" block (see [chapter 5.7.2, "LF Level Sweep"](#), on page 249).

5.6.1 LF Generator Settings

The "LF Generator/Noise" is used to perform the settings regarding the LF and noise generation.

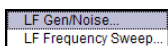

To open the "LF Generator/Noise" dialog, select "LF Gen./Noise > Configure > LF Gen./Noise" or use the MENU key under "LF Gen./Noise".

The LF Gen. 1/2 sections provide frequency and waveform shape settings for the two LF generators. In the "Noise Generator section", the settings for the noise source are provided.

The LF Gen. 1 section provides frequency and waveform shape settings for the first LF generator.

According to LF Gen. 1, the settings for the second LF generator are made in the LF Gen. 2 section.

LF Gen 1	
Frequency	1.000 0 kHz
Shape	Trapezoid
Trapezoid Period	1.000 00 ms
Trapezoid Rise	250.00 µs
Trapezoid Fall	250.00 µs
Trapezoid High	250.00 µs
LF Gen 2	
Frequency	1.000 0 kHz
Shape	Pulse
Pulse Period	1.000 00 ms
Pulse Width	500.00 µs
Pulse Duty Cycle	50.000 %
Noise Generator	
Distribution	Gauss
Bandwidth	0.1 MHz
Noise Density	-149.8 dBV/Hz
Noise Level	-99.8 dBV

Frequency – LF Generator

The frequency of the LF generator 1/2.

This setting affects all analog modulations which use the LF generator as the internal modulation source.

It depends on the used shape:

- "Sine"
Sets the repetition frequency of the internal signal. In this case the signal period results from this value, indicated in [Period](#).
- "Pulse, Triangle or Trapezoid "
Indicates the frequency resulting from the set signal [Period](#).

SCPI command:

[\[:SOURce\]:LFOutput<ch>:FREQuency](#) on page 422

LF Gen Shape

Selects the waveform shape of the LF signal.

SCPI command:

[\[:SOURce\]:LFOutput<ch>:SHAPE](#) on page 436

Period (Sine Shape) – LF Generator

Indicates the period of the LF sine signal. It is determined by the repetition frequency of the internal signal, see [Frequency](#).

Pulse Period – LF Generator

(This feature is available for shape mode Pulse only)

Sets the period of the generated pulse shape. The period determines the repetition frequency of the internal signal.

SCPI command:

[\[:SOURce\]:LFOutput<ch>:SHAPE:PULSe:PERiod](#) on page 436

Pulse Width – LF Generator

(This feature is available for shape mode Pulse only)

Sets the width of the generated pulse. The width determines the pulse length.

SCPI command:

[\[:SOURce\]:LFOutput<ch>:SHAPE:PULSE:WIDTH](#) on page 436

Pulse Duty Cycle – LF Generator

(This feature is available for shape mode Pulse only)

Sets the duty cycle for the shape pulse.

SCPI command:

[\[:SOURce\]:LFOutput<ch>:SHAPE:PULSE:DCYCLE](#) on page 436

Triangle Period – LF Generator

(This feature is available for shape mode Triangle only)

Sets the period of the generated triangle shape. The period determines the repetition frequency of the internal signal.

SCPI command:

[\[:SOURce\]:LFOutput<ch>:SHAPE:TRIangle:PERiod](#) on page 438

Triangle Rise – LF Generator

(This feature is available for shape mode Triangle only)

Sets the triangle shape rise time.

SCPI command:

[\[:SOURce\]:LFOutput<ch>:SHAPE:TRIangle:RISE](#) on page 438

Trapezoid Period – LF Generator

(This feature is available for shape mode Trapezoid only)

Sets the period of the generated trapezoid shape. The period determines the repetition frequency of the internal signal.

SCPI command:

[\[:SOURce\]:LFOutput<ch>:SHAPE:TRAPeze:PERiod](#) on page 437

Trapezoid Rise – LF Generator

(This feature is available for shape mode Trapezoid only)

Sets the trapeze shape rise time.

SCPI command:

[\[:SOURce\]:LFOutput<ch>:SHAPE:TRAPeze:RISE](#) on page 438

Trapezoid Fall – LF Generator

(This feature is available for shape mode Trapezoid only)

Sets the fall time for the trapeze shape of the LF generator.

SCPI command:

[\[:SOURce\]:LFOutput<ch>:SHAPE:TRAPeze:FALL](#) on page 437

Trapezoid High – LF Generator

(This feature is available for shape mode Trapezoid only)

Sets the high time for the trapeze shape of the LF generator.

SCPI command:

[\[:SOURce\]:LFOutput<ch>:SHAPE:TRAPeZe:HIGH](#) on page 437

5.6.2 Noise Settings

The parameters for the level distribution and the bandwidth for the noise source are provided in the "Noise Generator" section of the dialog. The settings affect all analog modulations which use the noise generator as the internal modulation source.

Distribution - Noise

Selects the noise power density distribution of the noise.

"Gaussian" The noise power density has a Gaussian distribution.

"Equal" The noise power density has an even distribution.

SCPI command:

[\[:SOURce<hw>\]:NOISe:DISTRibution](#) on page 455

Bandwidth - Noise

Enters the noise bandwidth. Distinct bandwidth settings between 100 kHz and 10 MHz in 100 kHz steps (range 100 .. 1 MHz), 1 MHz (range 1 MHz .. 5 MHz) and 5 MHz (5 MHz ... 10 MHz) are possible.

The noise signal is generated within the set frequency bandwidth. The noise level in the frequency band is indicated at Noise level (System Bandwidth).

SCPI command:

[\[:SOURce<hw>\]:NOISe:BWIDth](#) on page 455

Noise Density - Noise

Indicates the level of the noise signal for a bandwidth of 1 Hz.

SCPI command:

[\[:SOURce<hw>\]:NOISe:LEVel:RELative](#) on page 456

Noise Level - Noise

Indicates the level of the noise signal per Hz in the total bandwidth.

SCPI command:

[\[:SOURce<hw>\]:NOISe:LEVel\[:ABSolute\]](#) on page 456

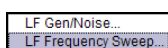
5.6.3 LF Frequency Sweep

The "LF Frequency Sweep" dialog is used to activate and configure a sweep for the LF frequency.

To open the dialog, select "LF Gen./Noise > Configure > LF Frequency Sweep" or use the MENU key under "LF Gen./Noise".

In the top section, the LF Sweep mode is activated and the sweep mode is selected. The buttons are used to reset the LF sweep (all sweep modes) or to execute the LF sweep ("Single" mode).

The sweep range, sweep spacing and dwell time are set in the bottom of the section.

Additionally, the trigger slope can be set.

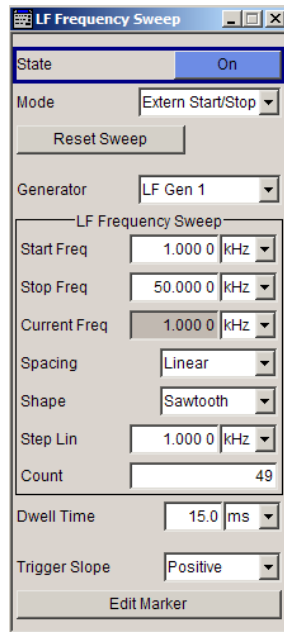

State - LF Sweep

Activates LF Sweep mode.

Note: Activating the LF frequency sweep automatically deactivates the List mode, RF frequency sweep, RF level sweep, and LF level sweep.

SCPI command:

[\[:SOURce\]:LFOutput:FREQuency:MODE](#) on page 423

Mode - LF Sweep

Selects the Sweep instrument operating mode and Sweep mode.

"Auto" Sets are automatic repeated sweep cycle. If a different sweep mode was activated prior to the "Auto" mode, the cycle continues from the current sweep setting.

The "Reset Sweep" button resets the sweep to the start frequency.

Example:

```
SOUR:LFO:SWE:FREQ:MODE AUTO
TRIG0:SWE:SOUR AUTO
SOUR:LFO:FREQ:MODE SWE
```

"Single" Sets a single sweep cycle. The sweep is triggered by the "Execute Single Sweep" button.
If a different sweep mode was activated prior to the "Single" mode, the current sweep is stopped. The "Single" sweep always starts at the start frequency.
The "Reset Sweep" button resets the sweep to the start frequency.

Example:

```
SOUR:LFO:SWE:FREQ:MODE AUTO
TRIG0:SWE:SOUR SING
SOUR:LFO:FREQ:MODE SWE
SOUR:LFO:SWE:FREQ:EXEC
```

"Step" Sets a step-by-step sweep cycle. Each sweep step is triggered by a variation of the value in the "Current Freq" entry window.
If this mode is activated, the cursor moves to the value displayed for "Current Freq". If a different sweep mode was activated prior to the "Step" mode, the current sweep is stopped. The "Step" sweep starts at the current LF frequency.
The "Reset Sweep" button resets the sweep to the start frequency.

Example:

```
SOUR:LFO:SWE:FREQ:MODE MAN
SOUR:LFO:FREQ:MODE SWE
SOUR:LFO:SWE:FREQ:SPAC LIN
SOUR:LFO:SWE:FREQ:STEP:LIN 1E34
SOUR:LFO:FREQ:MAN 12 kHz
```

The value entered with command

```
SOUR:LFO:SWE:FREQ:STEP:LIN|LOG
```

 sets the step width.

The value entered with command `SOUR:LFO:FREQ:MAN` has no effect, the command only sets the next sweep step. In remote control only a step-by-step sweep from start to stop frequency is possible

"Extern Single" Sets a single sweep cycle. The sweep is triggered by an external trigger signal.
If a different sweep mode was activated prior to the "Extern Single" mode, the current sweep is stopped. The "Extern Single" sweep always starts at the start frequency.
The external trigger signal is input at the rear of the instrument (BNC connector TRIGGER or AUX connector).
The "Reset Sweep" button resets the sweep to the start frequency.

Example:

```
SOUR:LFO:SWE:FREQ:MODE AUTO
TRIG0:SWE:SOUR EXT
SOUR:LFO:FREQ:MODE SWE (External trigger)
```

"Extern Step" Sets a step-by-step sweep cycle. Each sweep step is triggered by an external trigger signal (trigger source as described under "Extern Single"). The step width corresponds to the step width set for the rotary knob.

If a different sweep mode was activated prior to the "Extern Step" mode, the current sweep is stopped. The "Extern Step" sweep always starts at the LF start frequency.

The "Reset Sweep" button resets the sweep to the start frequency.

Example:

```
SOUR:LFO:SWE:FREQ:MODE AUTO
```

```
TRIG0:SWE:SOUR EXT
```

```
SOUR:LFO:FREQ:MODE SWE (External trigger)
```

"Extern Start/Stop" Sets an automatically repeated sweep cycle that is started, stopped and restarted by subsequent external trigger events.

The first external trigger signal starts the sweep (Start).

The next external trigger signal stops the sweep at the current frequency (Stop).

The third external trigger signal starts the sweep at the start frequency (Start).

If a different sweep mode was activated prior to the "Extern Start/Stop" mode, the current sweep is stopped and the "Extern Start/Stop" sweep starts at the start frequency when triggered.

The "Reset" button resets the sweep to the start frequency.

The external trigger signal is input at the rear of the instrument (BNC connector TRIGGER or AUX connector).

Example:

```
SOUR:LFO:SWE:FREQ:MODE AUTO
```

```
TRIG0:SWE:SOUR EAUT
```

```
SOUR:LFO:FREQ:MODE SWE (External trigger)
```

SCPI command:

[\[:SOURce\]:LFOutput:SWEep\[:FREQuency\]:MODE](#) on page 428

[:TRIGger<hw>\[:SWEep\]:SOURce](#) on page 521

[\[:SOURce\]:LFOutput:FREQuency:MODE](#) on page 423

Execute Single Sweep - LF Sweep

Triggers the sweep manually. A manual sweep can only be triggered if "Mode Single" is selected.

SCPI command:

[\[:SOURce\]:LFOutput:SWEep\[:FREQuency\]:EXECute](#) on page 426

Reset Sweep - LF Sweep

Resets the sweep. The start frequency is set and the next sweep starts from there.

SCPI command:

[\[:SOURce<hw>\]:SWEep:RESet\[:ALL\]](#) on page 499

Generator - LF Sweep

Selects the source for LF sweeps.

SCPI command:

[\[:SOURce\]:LFOutput:SWEep\[:FREQuency\]:LFSource](#) on page 426

Start Freq - LF Sweep

Sets the start frequency.

SCPI command:

[\[:SOURce\]:LFOutput:FREQuency:STARt](#) on page 423

Stop Freq - LF Sweep

Sets the stop frequency.

SCPI command:

[\[:SOURce\]:LFOutput:FREQuency:STOP](#) on page 424

Current Freq - LF Sweep

Displays the current frequency.

If "Step" is set, the frequency for the next frequency step of the sweep is entered here.

SCPI command:

[\[:SOURce\]:LFOutput:FREQuency:MANual](#) on page 422

Spacing - LF Sweep

Selects linear or logarithmic sweep spacing.

SCPI command:

[\[:SOURce\]:LFOutput:SWEep\[:FREQuency\]:SPACing](#) on page 430

Shape - LF Frequency Sweep

Selects the cycle mode for a sweep sequence (shape)

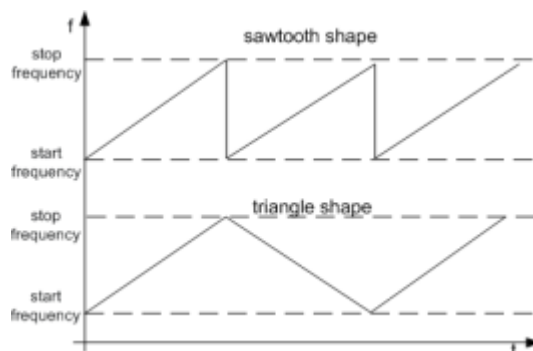

"Sawtooth"

One sweep runs from start to stop frequency. Each subsequent sweep starts at the start frequency, i.e. the shape of the sweep sequence resembles a sawtooth.

"Triangle" One sweep runs from start to stop frequency and back, i.e. the shape of the sweep resembles a triangle. Each subsequent sweep starts at the start frequency.

SCPI command:

`[:SOURce] :LFOutput :SWEep [:FREQuency] :SHAPE` on page 430

Step Lin/Log - LF Sweep

Sets the step width for the individual sweep steps. This entry is effective for all sweep modes.

"Step Lin" or "Step Log" is displayed depending on whether "Spacing Lin" or "Log" is selected.

"Step Lin" With the linear sweep, the step width is a fixed frequency value which is added to the current frequency. The linear step width is entered in Hz.

SCPI command:

`[:SOURce] :LFOutput :SWEep [:FREQuency] :STEP [:LINear]` on page 431

"Step Log" With the logarithmic sweep, the step width is a constant fraction of the current frequency. This fraction is added to the current frequency. The logarithmic step width is entered in %.

SCPI command:

`[:SOURce] :LFOutput :SWEep [:FREQuency] :STEP :LOGarithmic` on page 431

Count - LF Frequency Sweep

Sets the number of sweep steps.

SCPI command:

`[:SOURce] :LFOutput :SWEep [:FREQuency] :POINTs` on page 429

Dwell Time - LF Sweep

Sets the dwell time. The dwell time determines the duration of the individual sweep steps.

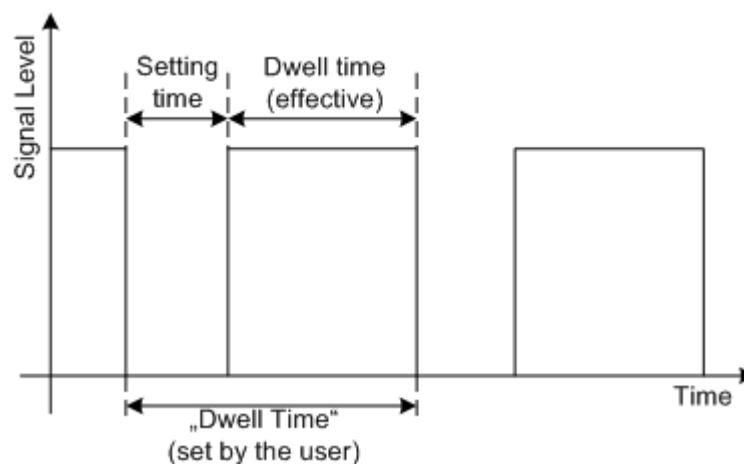

The "Dwell Time" set by the user is used as the step time of the sweep. The effective net dwell time is shorter, reduced by the setting time. This setting time may be greater than the time specified in the data sheet.

Note:

It is recommended to switch off the GUI update for optimum sweep performance especially with short dwell times (see [chapter 5.2.3.5, "Gui Update"](#), on page 96).

SCPI command:

`[:SOURce] :LFOutput :SWEep [:FREQuency] :DWELL` on page 426

Trigger Input Slope

Sets the polarity of the active slope of an applied instrument trigger.

This setting affects the TRIGGER input (BNC connector at the rear of the instrument or AUX connector).

"Positive" The rising edge of the trigger signal is active.

"Negative" The falling edge of the trigger signal is active.

SCPI command:

`[:SOURce] :INPut :TRIGger :SLOPe` on page 420

Edit Marker

Opens a dialog used for setting and editing the markers.

For a detailed description, see

- ["RF Frequency Marker"](#) on page 135
- [chapter 5.6, "LF Gen./Noise"](#), on page 235

SCPI command:

n.a.

5.6.4 LF Frequency Marker Settings

The "LF Frequency Marker" dialog is called via the EDIT MARKER button in the "LF Frequency Sweep" menu.

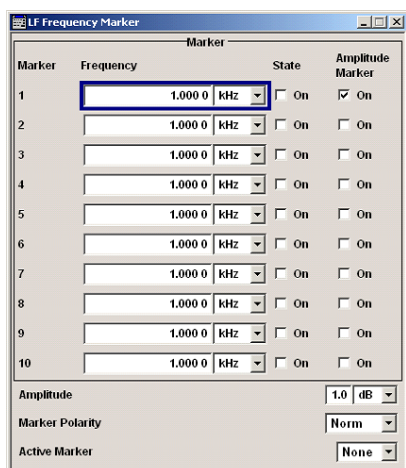

Up to ten frequency markers can be defined. The frequency of the marker signal at the MARKER output changes according to the selected polarity when the frequency mark is reached. For each of these markers an amplitude marker can be activated in addition. If

activated, the marker signal is attenuated by the set amplitude when the frequency mark is reached. Only one marker is output at the MARKER output at one time.

Marker - LF Frequency Marker

Displays the marker index.

SCPI command:

n.a.

Frequency - LF Frequency Marker

Enters the frequency for the corresponding marker. If the marker is activated, the signal level at the MARKER output changes on reaching this frequency mark.

SCPI command:

[\[:SOURce\]:LFOutput:SWEep\[:FREQuency\]:MARKer<ch>:FREQuency](#)

on page 427

State - LF Frequency Marker

Switches in or off the selected marker. If on, the marker is output at the MARKER output on reaching the mark.

SCPI command:

[\[:SOURce\]:LFOutput:SWEep\[:FREQuency\]:MARKer<ch>:FSTate](#) on page 428

Amplitude Marker - LF Frequency Marker

Activates or deactivates the selected amplitude marker. If activated, the level is reduced by the amplitude entered below on reaching the mark.

SCPI command:

[\[:SOURce\]:LFOutput:SWEep\[:FREQuency\]:MARKer<ch>:VSTate](#) on page 428

Amplitude - LF Frequency Marker

Sets the amplitude marker attenuation. This value is valid for all markers.

SCPI command:

[\[:SOURce\]:LFOutput:SWEep\[:FREQuency\]:MARKer:AMPLitude](#) on page 427

Marker Polarity - LF Frequency Marker

Selects the marker output polarity.

SCPI command:

[\[:SOURce<hw>\]:SWEep:MARKer:OUTPut:POLarity](#) on page 495

Active Marker - LF Frequency Marker

Selects the active marker. The active marker is output with a higher voltage than all other markers.

SCPI command:

[\[:SOURce\]:LFOutput:SWEep\[:FREQuency\]:MARKer:ACTive](#) on page 427

5.7 LF Output

The dialog is used to perform the settings regarding the LF output.

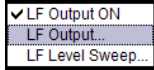

To open the "LF Output" dialog, select "LF Output > Configure > LF Output" or use the MENU key under "LF Output".



The LF Output requires option R&S SMF-B20.

In the upper section of the dialog, the LF output is activated and configured.

The "LF Generators" section displays the parameters of the LF Generators.

In the "External Inputs" section, the external inputs are configured. For a detailed description, see ["External Modulation Sources"](#) on page 216.

The screenshot shows the LF Output dialog with the following settings:

- Monitoring:** Off
- State:** Path 1: On, Path 2: Off
- Source:** Path 1: LF Generator 1, Path 2: LF Generator 2
- Output Voltage:** Path 1: 1.000 V, Path 2: 1.000 V
- DC Offset:** 0 mV
- LF Generators:**
 - Gen 1:** Shape: Sine, Frequency: 2.000 0 kHz, Period: 500.00 µs
 - Gen 2:** Shape: Trapezoid, Frequency: 1.000 00 kHz, Period: 1.000 00 ms
- External Inputs:**
 - EXT 1:** Coupling: AC, Impedance: 100 kΩ, Bandwidth: 10 MHz
 - EXT 2:** Coupling: AC, Impedance: 100 kΩ, Bandwidth: 10 MHz

5.7.1 LF Output Settings

Monitoring - LF Output

Selects the LF output monitoring mode. The settings for the LF output are synchronized to amplitude modulation or frequency/phase modulation settings.

SCPI command:

`[:SOURce] :LFOutput:MONitor:MODE` on page 424

State - LF Output

(This feature is available for monitoring mode Off only)

Activates/deactivates the LF Output.

The selected modulation signal is output at the LF output connector at the front of the instruments.

SCPI command:

`[:SOURce] :LFOutput<ch> [:STATe]` on page 425

Source – LF Output

(This feature is available for monitoring mode Off only)

Selects the internal and/or external source to be used for the LF output signal.

"LF Generator 1/2" Selects one of the internal LF generators as the source for the LF output signal.

"EXT 1/2" Selects one of the external inputs as the source for the LF output signal.

"Noise Generator" Selects the internal noise signal. The LF output signal is noise either with gaussian distribution or equal distribution.

SCPI command:

[\[:SOURce\]:LFOutput<ch>:SOURce](#) on page 425

Output Voltage - LF Output

(This feature is available for monitoring mode Off only)

Sets the output voltage of the LF output. The entered value determines the peak voltage.

SCPI command:

[\[:SOURce\]:LFOutput<ch>:VOLTage](#) on page 439

DC Offset - LF Output

(This feature is available for monitoring mode Off only)

Sets a DC offset at the LF Output.

SCPI command:

[\[:SOURce\]:LFOutput:OFFSet](#) on page 425

LF Gen Shape

Selects the waveform shape of the LF signal.

SCPI command:

[\[:SOURce\]:LFOutput<ch>:SHAPE](#) on page 436

Frequency – LF Generator

The frequency of the LF generator 1/2.

This setting affects all analog modulations which use the LF generator as the internal modulation source.

It depends on the used shape:

- "Sine"
Sets the repetition frequency of the internal signal. In this case the signal period results from this value, indicated in [Period](#).
- "Pulse, Triangle or Trapezoid "
Indicates the frequency resulting from the set signal [Period](#).

SCPI command:

[\[:SOURce\]:LFOutput<ch>:FREQuency](#) on page 422

Period (Sine Shape) – LF Generator

Indicates the period of the LF sine signal. It is determined by the repetition frequency of the internal signal, see [Frequency](#).

Period (Pulse, Triangle, Trapezoid Shape) – LF Generator

Sets the period of the current LF signal. The period determines the repetition frequency of the internal signal, see [Frequency](#).

SCPI command:

[:SOURce] :LFOutput<ch>:SHAPE:PULSE:PERiod on page 436

[:SOURce] :LFOutput<ch>:SHAPE:TRAPeZe:PERiod on page 437

[:SOURce] :LFOutput<ch>:SHAPE:TRIangle:PERiod on page 438

5.7.2 LF Level Sweep

The "LF Level Sweep" dialog is used to activate and configure a sweep for the LF level.



To open the dialog, select "LF Output > Configure > LF Level Sweep" or use the MENU key under "LF Output".

5.7.2.1 LF Level Sweep Settings

In the top section, the LF level sweep mode is activated and the sweep mode is selected. The buttons are used to reset the LF sweep (all sweep modes) or to execute the LF sweep (Single mode).

In the "LF Level Sweep" section, the sweep range, and other settings regarding the sweep can be done.

In the bottom section, the dwell time and the trigger slope can be set.

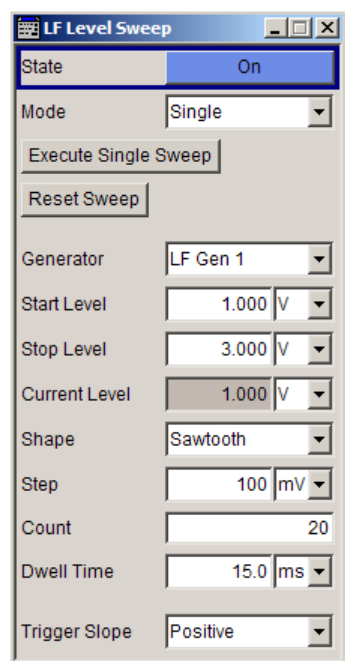

State - LF Level Sweep

Activates/deactivates LF level sweep mode.

Note: Activating the LF level sweep automatically deactivates the List mode, RF frequency sweep, RF level sweep, and LF frequency sweep.

SCPI command:

[:SOURce] :LFOutput :VOLTage :MODE on page 440

Mode - LF Level Sweep

Selects the sweep instrument operating mode and sweep mode.

"Auto" Sets an automatic repeated sweep cycle. If a different sweep mode was activated prior to the "Auto" mode, the cycle continues from the current sweep setting.
The "Reset Sweep" button resets the sweep to the start frequency.

Example:

```
SOUR:LFO:SWE:VOLT:MODE AUTO
TRIG:LFVS:SOUR AUTO
SOUR:LFO:VOLT:MODE SWE
```

"Single" Sets a single sweep cycle. The sweep is triggered by the "Execute Single Sweep" button.
If a different sweep mode was activated prior to the "Single" mode, the current sweep is stopped. The single sweep always starts at the start frequency.
The "Reset Sweep" button resets the sweep to the start level.

Example:

```
SOUR:LFO:SWE:VOLT:MODE MAN
TRIG:LFVS:SOUR SING
SOUR:LFO:VOLT:MODE SWE
SOUR:LFO:SWE:VOLT:EXEC
```

"Step" Sets a step-by-step sweep cycle. Each sweep step is triggered by a variation of the value in the "Current Freq" entry window.
If this mode is activated, the cursor moves to the value displayed for "Current Freq". If a different sweep mode was activated prior to the "Step" mode, the current sweep is stopped. The step sweep starts at the current LF frequency.

Example:

```
SOUR:LFO:SWE:VOLT:MODE STEP
TRIG:LFVS:SOUR SING
SOUR:LFO:VOLT:MAN 12kHz
TRIG:LFVS:SOUR SING
SOUR:LFO:VOLT:MODE SWE
SOUR:LFO:VOLT:MAN 14kHz
SOUR:LFO:VOLT:MAN 16kHz
```

"Extern Single" Sets a single sweep cycle. The sweep is triggered by an external trigger signal.
If a different sweep mode was activated prior to the Extern Single mode, the current sweep is stopped. The Extern Single sweep always starts at the start frequency.
The external trigger signal is input at the rear of the instrument (BNC connector TRIGGER or AUX connector).
The "Reset Sweep" button resets the sweep to the start level.

Example:

```
SOUR:LFO:SWE:VOLT:MODE MAN
TRIG:LFVS:SOUR EXT
SOUR:LFO:VOLT:MODE SWE
```

"Extern Step" Sets a step-by-step sweep cycle. Each sweep step is triggered by an external trigger signal (trigger source as described under "Extern Single"). The step width corresponds to the step width set for the rotary knob.
If a different sweep mode was activated prior to the "Extern Step" mode, the current sweep is stopped. The "Extern Step" sweep always starts at the LF start frequency.
The "Reset Sweep" button resets the sweep to the start level.

Example:

```
SOUR:LFO:SWE:VOLT:MODE STEP
SOUR:LFO:SWE:VOLT:STEP:LIN 2
TRIG:LFVS:SOUR EXT
SOUR:LFO:VOLT:MODE SWE
```

"Extern Start/ Stop" Sets an automatically repeated sweep cycle that is started, stopped and restarted by subsequent external trigger events. The first external trigger signal starts the sweep (Start). The next external trigger signal stops the sweep at the current LF frequency (Stop). The third external trigger signal starts the sweep at the start frequency (Start). If a different sweep mode was activated prior to the "Extern Start/ Stop" mode, the current sweep is stopped and the "Extern Start/Stop" sweep starts at the start frequency when triggered. The "Reset" button resets the sweep to the start level. Refer to the description of the rear panel for information about the connectors for external trigger signal input (see [chapter 2.2, "Rear Panel Tour"](#), on page 22).

Example:

```
SOUR:LFO:SWE:VOLT:MODE AUTO
TRIG:LFVS:SOUR EAUT
SOUR:LFO:VOLT:MODE SWE (External trigger)
```

SCPI command:

[\[:SOURce\]:LFOutput:SWEep:VOLTage:MODE](#) on page 434
[:TRIGger<hw>:LFVSweep:SOURce](#) on page 519
[\[:SOURce\]:LFOutput:VOLTage:MODE](#) on page 440

Execute Single Sweep - LF Level Sweep

Triggers the sweep manually. A manual sweep can only be triggered if "Mode Single" is selected.

Example:

```
SOUR:LFO:SWE:VOLT:MODE AUTO
TRIG:LFVS:SOUR SING
SOUR:LFO:VOLT:MODE SWE
```

SCPI command:

[\[:SOURce\]:LFOutput:SWEep:VOLTage:EXECute](#) on page 432

Reset Sweep - LF Level Sweep

Resets the sweep. The start frequency is set and the next sweep starts from there.

SCPI command:

[\[:SOURce<hw>\]:SWEep:RESet\[:ALL\]](#) on page 499

Generator - LF Level Sweep

Sets the source for the LF level sweep.

SCPI command:

[\[:SOURce\]:LFOutput:SWEep:VOLTage:LFSource](#) on page 433

Start Level - LF Level Sweep

Sets the start frequency.

SCPI command:

[\[:SOURce\]:LFOutput:VOLTage:START](#) on page 440

Stop Level - LF Level Sweep

Sets the stop frequency.

SCPI command:

[\[:SOURce\]:LFOutput:VOLTage:STOP](#) on page 441

Current Level - LF Level Sweep

Displays the current frequency.

If "Step" is set, the frequency for the next frequency step of the sweep is entered here.

SCPI command:

[\[:SOURce\]:LFOutput:VOLTage:MANual](#) on page 439

Shape - LF Level Sweep

Selects the cycle mode for a sweep sequence (shape) .

"Sawtooth" One sweep runs from the start level to the stop level. The subsequent sweep starts at the start level again, i.e. the shape of sweep sequence resembles a sawtooth.

"Triangle" One sweep runs from start to stop level and back, i.e. the shape of the sweep resembles a triangle. Each subsequent sweep starts at the start level again.

SCPI command:

[\[:SOURce\]:LFOutput:SWEep:VOLTage:SHAPE](#) on page 435

Step - LF Level Sweep

Sets the step width for the individual sweep steps.

SCPI command:

[\[:SOURce\]:LFOutput:SWEep:VOLTage:STEP\[:LINear\]](#) on page 435

Count - LF Level Sweep

Sets the number of sweep steps.

SCPI command:

[\[:SOURce\]:LFOutput:SWEep:VOLTage:POINTs](#) on page 434

Dwell Time - LF Level Sweep

Sets the dwell time. The dwell time determines the duration of the individual sweep steps.

SCPI command:

[\[:SOURce\]:LFOutput:SWEep:VOLTage:DWELl](#) on page 432

Trigger Input Slope

Sets the polarity of the active slope of an applied instrument trigger.

This setting affects the TRIGGER input (BNC connector at the rear of the instrument or AUX connector).

"Positive" The rising edge of the trigger signal is active.

"Negative" The falling edge of the trigger signal is active.

SCPI command:

[\[:SOURce\]:INPut:TRIGger:SLOPe](#) on page 420

Edit Marker - Level Sweep

Opens the LF Level Marker menu. This menu is used for setting and editing the markers.

For a detailed description, see [chapter 5.7.3, "LF Level Marker Settings"](#), on page 254.

SCPI command:

n.a.

5.7.3 LF Level Marker Settings

The "LF Level Marker" dialog is called via the EDIT MARKER button in the "LF Level Sweep" dialog.

Marker		
Marker Level		State
1	-30.00 dBm	<input type="checkbox"/> On
2	-30.00 dBm	<input type="checkbox"/> On
3	-30.00 dBm	<input type="checkbox"/> On
4	-30.00 dBm	<input type="checkbox"/> On
5	-30.00 dBm	<input type="checkbox"/> On
6	-30.00 dBm	<input type="checkbox"/> On
7	-30.00 dBm	<input type="checkbox"/> On
8	-30.00 dBm	<input type="checkbox"/> On
9	-30.00 dBm	<input type="checkbox"/> On
10	-30.00 dBm	<input type="checkbox"/> On
Marker Polarity		Normal
Active Marker		None

Marker - LF Level Marker

Displays the index of the marker.

SCPI command:

n.a.

Level - LF Level Marker

Enters the level for the corresponding marker. If the marker is activated, the signal level at the MARKER output changes according to the set polarity on reaching the entered level.

SCPI command:

`[:SOURce<hw>] :LFOutput :SWEep :VOLTage :MARKer<ch> :VOLTage`

on page 433

State - LF Level Marker

Activates or deactivates the selected marker. If on, the marker is output at the MARKER output on reaching the mark.

SCPI command:

`[:SOURce<hw>] :LFOutput :SWEep :VOLTage :MARKer<ch> :VState` on page 434

Marker Polarity - LF Level Marker

Selects the marker output polarity.

SCPI command:

`[:SOURce<hw>] :SWEep :MARKer :OUTPut :POLarity` on page 495

Active Marker - LF Level Marker

Selects the active marker. The active marker is output with an higher voltage than all other markers.

SCPI command:

`[:SOURce] :LFOutput :SWEep :VOLTage :MARKer :ACTive` on page 433

5.8 Pulse Generator

The "Pulse Generator" dialog is used to activate and configure a pulse modulation signal.

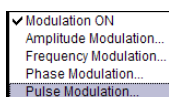

To open the "Pulse Modulation / Generator" menu, select "Modulation > Configure > Pulse Modulation", or select "Pulse Mod > Configure > Pulse Modulation", or use the MENU key under "Modulation".

The pulse generator requires option R&S SMF-K23, it provides single and double pulse modulation with selectable pulse widths and periods. The signal is output at the PULSE OUT connector.

In addition, the generation of a user-definable pulse train is enabled with option R&S SMF-K27 and narrow pulse modulation with option R&S SMF-K3.

5.8.1 Pulse Generator Settings

The settings for the pulse characteristics and the trigger are provided in the "Pulse Generator" section of the "Pulse Modulation" dialog.

The screenshot shows a 'Pulse Generator' control window with the following settings:

- Pulse Mode: Double
- Pulse Period: 10.000 µs
- Pulse Width: 2.000 µs
- Double Pulse Width: 3.000 µs
- Double Pulse Delay: 3.000 µs
- Pulse Output State: On
- Pulse Output Polarity: Normal

The parameters vary according to the selected pulse mode, i.e. "Single", "Double" or "Train". Option R&S SMF-K23 offers extended features, e.g. generation of double pulse or selection of trigger mode. Option R&S SMF-K27 enables the generation of pulse trains.

Pulse Mode - Pulse Generator

Sets the mode of the pulse generator.

Note: Single and double are available with option R&S SMF-K23, selection pulse train requires option R&S SMF-K27.

- "Single" A single pulse is generated in one pulse period.
- "Double" Two pulses are generated in one pulse period. Additional settings for the double pulse are available in the menu.
- "Train" Requires option R&S SMF-K27.
A user-defined pulse train is generated. Additional settings for the pulse train are available in the menu after selection of the pulse train mode (see [chapter 5.8.2, "Pulse Train Generation"](#), on page 259).
A pulse train is a sequence of pulses with user-defined on and off times. The ontime/offtime value pairs are defined in a pulse train list. The currently used pulse train file is displayed in the sub menu.

SCPI command:

[\[:SOURce<hw>\]:PULM:MODE](#) on page 471

Pulse Period - Pulse Generator

Sets the period of the generated pulse. The period determines the repetition frequency of the internal signal.

SCPI command:

[\[:SOURce<hw>\]:PULM:PERiod](#) on page 472

Pulse Width - Pulse Generator

Sets the width of the generated pulse. The width determines the pulse length. The pulse width must be at least 20 ns less than the set pulse period.

SCPI command:

[\[:SOURce<hw>\]:PULM:WIDTh](#) on page 483

Pulse Delay - Pulse Generator

Sets the pulse delay. The pulse delay determines the time that elapses after a trigger event before pulse modulation starts. The pulse delay is not effective for double pulse generation.

SCPI command:

[\[:SOURce<hw>\]:PULM:DELay](#) on page 470

Double Pulse Width - Pulse Generator

(Double Pulse only)

Sets the width of the second pulse.

SCPI command:

[\[:SOURce<hw>\]:PULM:DOUBle:WIDTh](#) on page 471

Double Pulse Delay - Pulse Generator

(Double Pulse only)

Sets the delay from the start of the first pulse to the start of the second pulse.

SCPI command:

[\[:SOURce<hw>\]:PULM:DOUBle:DELay](#) on page 470

Pulse Output State – Pulse Generator

Activates/deactivates the pulse generator output at the PULSE OUT connector

SCPI command:

[\[:SOURce<hw>\]:PGEN:OUTPut\[:STATe\]](#) on page 457

Output Polarity – Pulse Generator

Sets the polarity of the output signal (PULSE OUT connector).

SCPI command:

[\[:SOURce<hw>\]:PGEN:OUTPut:POLarity](#) on page 456

Trigger Mode - Pulse Generator

Selects the trigger mode for pulse modulation.

- | | |
|--------------|--|
| "Auto" | The pulse generator signal is generated continuously. |
| "Ext Single" | The pulse modulation is triggered by an external trigger event. The trigger signal is supplied via the PULSE IN connector. |

"Ext Gated" The pulse generator signal is gated by an external gate signal. The signal is supplied via the PULSE IN connector.

Example: Generation of pulse signals using trigger modes Ext gated (Single Pulse)

The measurement were made using a 6-dB-attenuator.

Parameter	Value
Trigger Mode	Ext Gated
Double Pulse State	Off
External Trigger Input Slope	Positive
Pulse Delay	100 ns
Pulse Width	100 ns
Pulse Period	300 ns

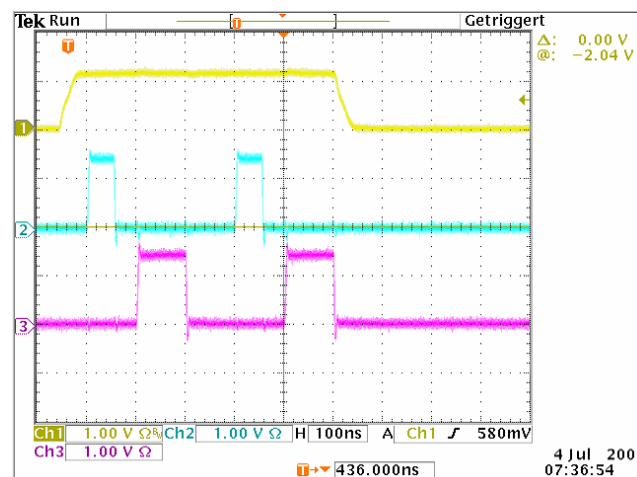

Chan- = Indicates the external gate signal which is input at the PULSE EXT connector.
 nel 1 The signal is active when it is high (positive).
 Chan- = Indicates the sync signal. The sync signal starts after a trigger delay of typically
 nel 2 50 ns (see specifications). It is repeated after the set pulse period of 300 ns
 as long as the gate signal is active. The sync signal is output at the (PULSE)
 SYNC connector.
 Chan- = Indicates the pulse signal. The first pulse starts after the pulse delay of 100
 nel 3 ns. The second pulse starts after the set pulse period. They are output at the
 (PULSE) VIDEO connector.

SCPI command:

`[:SOURce<hw>] :PULM:TRIGger:MODE` on page 479

Trigger Level – Input/Trigger Settings

Selects the external trigger level (threshold TTL, 0.5 V or -2.5 V).

SCPI command:

`[:SOURce<hw>] :PULM:TRIGger:EXTernal:LEVel` on page 478

External Trigger Input Slope - Pulse Generator (External Trigger only)

Sets the polarity of the active slope of an applied trigger signal.

"Positive" The pulse generator is triggered on the positive slope of the external trigger signal.

"Negative" The pulse generator is triggered on the negative slope of the external trigger signal.

SCPI command:

[\[:SOURce<hw>\]:PULM:TRIGger:EXTernal:SLOPe](#) on page 479

Gate Input Polarity - Pulse Generator

Selects the polarity of the Gate signal.

The signal is supplied via the PULSE IN connector.

"Normal" The pulse signal is generated while the gate signal is high.

"Inverse" The pulse signal is generated while the gate signal is low.

SCPI command:

[\[:SOURce<hw>\]:PULM:TRIGger:EXTernal:GATE:POLarity](#) on page 478

Pulse External Input Impedance

Selects the impedance for external pulse trigger.

SCPI command:

[\[:SOURce<hw>\]:PULM:TRIGger:EXTernal:IMPedance](#) on page 478

5.8.2 Pulse Train Generation

Upon selection of mode pulse train the menu is extended for configuring a user-defined pulse train.

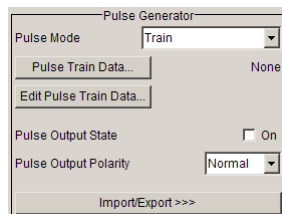

A pulse train is a sequence of pulses with user-defined on and off times. The ontime/offtime value pairs are defined in a pulse train list. The currently used pulse train file is displayed in the sub menu.

An internally created pulse train list can be exported or externally created list can be imported.

Pulse Train Data – Pulse Generator

Calls the "File Select" menu for selecting and creating a pulse train file or to open the "File Manager".

SCPI command:

`[:SOURce<hw>] :PULM:TRAI:n:CATalog` on page 474

`[:SOURce<hw>] :PULM:TRAI:n:SElect` on page 477

`[:SOURce<hw>] :PULM:TRAI:n:DElete` on page 474

Edit Pulse Train Data – Pulse Generator

Calls the [Pulse Train Dialog](#).

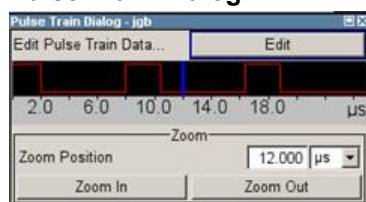
Pulse Train Dialog

The pulse train defined by the selected file is displayed.

The display of the pulse train can be zoomed, the zoom center is defined by the blue marker.

- "Edit" Calls the [Edit Pulse Train Data](#) dialog for editing the pulse train.
- "Zoom Position" Positions the blue marker in the pulse train. The marker defines the center of any zoom in or zoom out action.
- "Zoom In/Out" Zooms in or out the graphical display of the pulse train. The zoom factor of each zoom action is 2.

Edit Pulse Train Data

(For Pulse Mode Train only)

Calls the editor for editing the ontime/offtime values of the selected file. A file consists of any number of ontime/offtime value pairs. The currently selected file is displayed.

	ON-Time/μs	OFF-Time/μs	Count
1	85.000	25.000	1
2	55.000	25.000	1
3	85.000	25.000	2
4			

Goto Edit Save As... Save

"Ontime/μs" Sets the ontime of the ontime/offtime value pair.

SCPI command:

`[:SOURce<hw>] :PULM:TRAI:n:ONTIME` on page 475

"Offtime/μs" Sets the offtime of the ontime/offtime value pair.

SCPI command:

`[:SOURce<hw>] :PULM:TRAI:n:OFFTIME` on page 474

"Count" Sets the number of repetitions for each ontime/offtime value pair.

SCPI command:

[\[:SOURCE<hw>\]:PULM:TRAI:n:REPetition](#) on page 476

"Goto" Selects row for editing.

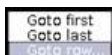

If Goto row is selected, a window opens for entering the requested row.



(it is not possible to change individual positions of the list)

"Edit" Calls a selection of possible actions described below.



"Insert Row" Insert a new row before the marked row.

"Insert Range" Insert new rows before the marked row. The number of rows to be inserted can be defined in an entry window.



"Fill...." Opens a sub menu for defining a set of list values to be automatically entered in the list.

The start line and the number of rows to be filled are defined under "From" and "Range".

The column to be filled is selected under "Select column to fill". Depending on the selection here, the default for start, end, and increment value are set. As the settings are interdependent, a change of one parameter may result in the automatic change of one or more of the other parameters.

The filling of the column with the selected value settings is started with button "Fill".

"Delete Row" Deletes the marked row.

"Delete Range" Deletes the selected number of rows including the marked row. The number of rows to be inserted can be defined in an entry window.

"Save As" Open the file menu to save the list under a new name.

Each list is saved to the CompactFlash™ card as a separate file with the file prefix *.pulstrn. The file name and the directory to which the file is saved are user-selectable.

"Save" The list is saved under its current name.

Import/Export - Pulse Train Mode

Expands the menu with the area for import and export of pulse train files.

Externally edited Excel tables with on/off time and repetition triplets can be imported as text files or CSV files and used for pulse train mode.

On the other hand, internally created pulse train lists can be exported as text files or CSV files.

Mode – Import/Export Pulse Train Files

Selects if pulse train lists should be imported or exported. The settings offered below depend on the selected mode.

SCPI command:

`[:SOURce<hw>] :PULM:TRAI:n:DEXChange:MODE` on page 482

Extension – ASCII File Settings

Selects the file extension of the ASCII file to be imported or exported. Selection TXT (text file) or CSV (Excel file) is available.

SCPI command:

`[:SOURce<hw>] :PULM:TRAI:n:DEXChange:AFIle:EXTension` on page 480

Decimal Point - ASCII File Settings

Selects the decimal separator used in the ASCII data between '.' (decimal point) and ',' (comma) with floating-point numerals.

SCPI command:

`[:SOURce<hw>] :PULM:TRAI:n:DEXChange:AFIle:SEParator:DECimal`
on page 481

Column Separator- ASCII File Settings

Selects the separator between the frequency and level column of the ASCII table.

SCPI command:

`[:SOURce<hw>] :PULM:TRAI:n:DEXChange:AFIle:SEParator:COLumn`
on page 481

Select ASCII Source / Destination - Import/Export Pulse Train Files

Calls the "File Manager" for selecting the ASCII file to be imported into a pulse train list (source) or the ASCII file the pulse train list is exported (destination) in.

SCPI command:

`[:SOURce<hw>] :PULM:TRAI:n:DEXChange:AFIle:CATalog` on page 479

`[:SOURce<hw>] :PULM:TRAI:n:DEXChange:AFIle:SElect` on page 480

Select Destination / Source - Import/Export Pulse Train Files

Calls the "File Manager" for selecting the pulse train list to be exported (source) into an ASCII file or the destination for the ASCII file to be imported (destination) in.

SCPI command:

`[:SOURce<hw>] :PULM:TRAI:n:DEXChange:SElect` on page 483

Import / Export - Import/Export Pulse Train Files

Starts the export or import of the selected file.

If import is selected, the ASCII file is imported as pulse train list.

If export is selected, the pulse train list is exported into the selected ASCII file.

SCPI command:

[\[:SOURce<hw>\]:PULM:TRain:DEXChange:EXECute](#) on page 482

5.9 Attenuator

The "Attenuator Settings" dialog is used to set the attenuator for the RF output. To open the "Attenuator" dialog, select "Attenuator > Configure" or use the MENU key under "Attenuator".



The attenuator requires option R&S SMF-B26 or R&S SMF-B27.

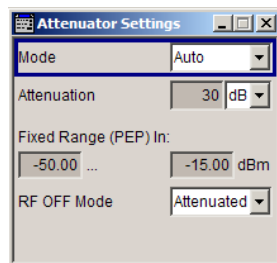

5.9.1 Attenuator Settings

For instruments equipped with a step attenuator, setting of the parameters is provided in the "Attenuator Settings" section.

Mode – Attenuator Settings

Sets the attenuator mode at the RF output.

"Auto" The mechanical attenuator switches in steps of 10 dB at fixed points.

"Fixed" The attenuator is fixed at the current position.

SCPI command:

[:OUTPut<hw>:AMODE](#) on page 334

Attenuation – Attenuation Settings

Sets the attenuation. To enter a value in this field, the attenuator mode Fixed has to be selected. If Auto is selected, this field is read-only.

SCPI command:

[\[:SOURce\]:POWER:ATTenuation](#) on page 462

Fixed Range in (PEP): - Attenuation Settings

Displays the level range in which the level is set without interruption for the attenuator mode Fixed setting.

SCPI command:

`:OUTPut<hw>:AFIXed:RANGe:LOWer` on page 333

`:OUTPut<hw>:AFIXed:RANGe:UPPer` on page 333

RF OFF Mode - Attenuation Settings

Selects the mode of the mechanical attenuator, when the RF signal is switched off.

Note: This feature is only available when the instrument is equipped with one of the mechanical attenuator options, i.e. either option R&S SMF-B26 or R&S SMF-B27.

The setting of the RF OFF mode is not affected by an instrument preset (PRESET key), *RST and the "Save/Recall" function. This parameter is influenced only by the [Factory Preset](#).

- | | |
|--------------|--|
| "Normal" | The current attenuation remains when the RF signal is switched off and thus provides fast and wear-free operation. |
| "Attenuated" | The attenuation is set to maximum when the RF signal is switched off. This setting is recommended for applications that require a high level of noise suppression. |

SCPI command:

`[:SOURce<hw>] :POWER:ATTenuation:RFOff:MODE` on page 462

5.10 R&S SMZ Frequency Multiplier



By connecting an R&S SMZ Frequency Multiplier, the R&S SMF indicates a separate block. The instrument automatically detects the connected multiplier model and displays it accordingly in the block, including the frequency range. If a frequency multiplier with mechanical level control is connected, the frequency range changes to the corresponding scale-setting for the adjusting screw. The R&S SMF also changes its frequency and level display to the appropriate values of the R&S SMZxxx signal output (status bar).

For information concerning the configuration refer to the manual of your the R&S SMZ Multiplier.

6 Remote Control Basics

This chapter provides basic information on operating an instrument via remote control.

6.1 Remote Control Interfaces and Protocols

The instrument supports different interfaces for remote control. The following table gives an overview.

Table 6-1: Remote control interfaces and protocols

Interface	Protocols, VISA ^{*)} address string	Remarks
Local Area Network (LAN)	Protocols: <ul style="list-style-type: none"> VXI-11 socket communication (Raw Ethernet, simple telnet) VISA ^{*)} address string: TCP/IP::host address[:LAN device name][:INSTR]	A LAN connector is located on the front or rear panel of the instrument, or both. The interface is based on TCP/IP and supports various protocols. For a description of the protocols refer to: <ul style="list-style-type: none"> chapter 6.1.3.1, "VXI-11 Protocol", on page 268 chapter 6.1.3.2, "Socket Communication", on page 268
USB	VISA ^{*)} address string: USB::<vendor ID>::<product ID>::<serial number>[:INSTR]	USB connectors are located on the front or the rear panel of the instrument, or both. For a description of the interface refer to chapter 6.1.4, "USB Interface" , on page 269
Serial Interface	VISA ^{*)} address string: ASRL[0-9][:INSTR]	For a description of the interface refer to chapter 6.1.5, "Serial Interface" , on page 269.
GPIB (IEC/IEEE Bus Interface)	VISA ^{*)} address string: GPIB::primary address[:INSTR] (no secondary address)	Optional GPIB bus interfaces according to standard IEC 625.1/IEEE 488.1 are located on the rear panel of the instrument. For a description of the interface refer to chapter 6.1.6, "GPIB Interface (IEC/IEEE Bus Interface)" , on page 270.

^{*)} VISA is a standardized software interface library providing input and output functions to communicate with instruments. A VISA installation on the controller is a prerequisite for remote control over LAN (when using VXI-11 protocol), USB and serial interface. However, no VISA installation is necessary to remote control while using socket communication. For more information, see [chapter 6.1.1, "VISA Libraries"](#), on page 266.



Within this interface description, the term GPIB is used as a synonym for the IEC/IEEE bus interface.

SCPI (Standard Commands for Programmable Instruments)

SCPI commands - messages - are used for remote control. Commands that are not taken from the SCPI standard follow the SCPI syntax rules. The instrument supports the SCPI version 1999. The SCPI standard is based on standard IEEE 488.2 and aims at the

standardization of device-specific commands, error handling and the status registers. The tutorial "Automatic Measurement Control - A tutorial on SCPI and IEEE 488.2" from John M. Pieper (R&S order number 0002.3536.00) offers detailed information on concepts and definitions of SCPI.

Tables provide a fast overview of the bit assignment in the status registers. The tables are supplemented by a comprehensive description of the status registers.

6.1.1 VISA Libraries

VISA is a standardized software interface library providing input and output functions to communicate with instruments. The I/O channel (LAN or TCP/IP, USB, GPIB,...) is selected at initialization time by means of the channel-specific address string ("VISA resource string"), or by an appropriately defined VISA alias (short name). A VISA installation is a prerequisite for remote control using the following interfaces:

- [chapter 6.1.3.1, "VXI-11 Protocol"](#), on page 268
- [chapter 6.1.4, "USB Interface"](#), on page 269
- [chapter 6.1.6, "GPIB Interface \(IEC/IEEE Bus Interface\)"](#), on page 270
- [chapter 6.1.5, "Serial Interface"](#), on page 269

For more information about VISA refer to the user documentation.

6.1.2 Messages

The messages transferred on the data lines are divided into the following categories:

- **Interface messages**
Interface messages are transmitted to the instrument on the data lines, with the attention line being active (LOW). They are used to communicate between the controller and the instrument. Interface messages can only be sent by instruments that have GPIB bus functionality. For details see the sections for the required interface.
- **Instrument messages**
Instrument messages are employed in the same way for all interfaces, if not indicated otherwise in the description. Structure and syntax of the instrument messages are described in [chapter 6.3, "SCPI Command Structure"](#), on page 284. A detailed description of all messages available for the instrument is provided in the chapter "Remote Control Commands".
There are different types of instrument messages, depending on the direction they are sent:
 - Commands
 - Instrument responses

Commands

Commands (program messages) are messages the controller sends to the instrument. They operate the instrument functions and request information. The commands are subdivided according to two criteria:

- According to the effect they have on the instrument:

- **Setting commands** cause instrument settings such as a reset of the instrument or setting the frequency.
- **Queries** cause data to be provided for remote control, e.g. for identification of the instrument or polling a parameter value. Queries are formed by directly appending a question mark to the command header.
- According to their definition in standards:
 - **Common commands:** their function and syntax are precisely defined in standard IEEE 488.2. They are employed identically on all instruments (if implemented). They refer to functions such as management of the standardized status registers, reset and self test.
 - **Instrument control commands** refer to functions depending on the features of the instrument such as frequency settings. Many of these commands have also been standardized by the SCPI committee. These commands are marked as "SCPI compliant" in the command reference chapters. Commands without this SCPI label are device-specific, however, their syntax follows SCPI rules as permitted by the standard.

Instrument responses

Instrument responses (response messages and service requests) are messages the instrument sends to the controller after a query. They can contain measurement results, instrument settings and information on the instrument status.

6.1.3 LAN Interface

To be integrated in a LAN, the instrument is equipped with a LAN interface, consisting of a connector, a network interface card and protocols. For remote control via a network, the PC and the instrument must be connected via the LAN interface to a common network with TCP/IP network protocol. They are connected using a commercial RJ45 cable. The TCP/IP network protocol and the associated network services are preconfigured on the instrument. Software for instrument control and (for specified protocols only) the VISA program library must be installed on the controller.

VISA library

Instrument access via VXI11 protocols is usually achieved from high level programming platforms using VISA as an intermediate abstraction layer. VISA encapsulates the low level VXI or GPIB function calls and thus makes the transport interface transparent for the user. See [chapter 6.1.1, "VISA Libraries"](#), on page 266 for details.

IP address

Only the IP address or the computer name (LAN device name) is required to set up the connection. The IP address/computer name is part of the "visa resource string" used by the programs to identify and control the instrument. The visa resource string has the form:

TCPIP::host address[::LAN device name][::INSTR] , where:

- **TCPIP** designates the network protocol used
- **host address** is the IP address

- **LAN device name** is the computer name of the control device (alternative to IP address)
- **INSTR** indicates that the VXI-11 protocol is used

Example:

Instrument has the IP address *192.1.2.3*; the valid resource string is:

```
TCPIP::192.1.2.3::INSTR
```

Computer name is *RSSM1*; the valid resource string is:

```
TCPIP::RSSM1::INSTR
```

**Identifying instruments in a network**

If several instruments are connected to the network, each instrument has its own IP address and associated resource string. The controller identifies these instruments by means of the resource string.

6.1.3.1 VXI-11 Protocol

The VXI-11 standard is based on the ONC RPC (Open Network Computing Remote Procedure Call) protocol which in turn relies on TCP/IP as the network/transport layer. The TCP/IP network protocol and the associated network services are preconfigured. TCP/IP ensures connection-oriented communication, where the order of the exchanged messages is adhered to and interrupted links are identified. With this protocol, messages cannot be lost.

6.1.3.2 Socket Communication

An alternative way for remote control of the software is to establish a simple network communication using sockets. The socket communication, also referred as “Raw Ethernet communication”, does not necessary require a VISA installation on the remote controller side.

The simplest way to establish socket communication is to use the built-in telnet program. The telnet program is part of every operating system and supports a communication with the software on a command-by-command basis. For better utilization and to enable automation by means of programs, user defined sockets can be programmed.

Socket connections are established on a specially defined port. The socket address is a combination of the IP address or the host name of the instrument and the number of the port configured for remote-control. All R&S Microwave Signal Generator use port number 5025 for this purpose. The port is configured for communication on a command-to-command basis and for remote control from a program.

6.1.3.3 LAN Interface Messages

In the LAN connection, the interface messages are called low-level control messages. These messages can be used to emulate interface messages of the GPIB bus.

Command	Long term	Effect on the instrument
&ABO	Abort	Aborts processing of the commands just received.
&DCL	Device Clear	Aborts processing of the commands just received and sets the command processing software to a defined initial state. Does not change the instrument setting.
>L	Go to Local	Transition to the "local" state (manual control).
>R	Go to Remote	Transition to the "remote" state (remote control).
&GET	Group Execute Trigger	Triggers a previously active instrument function (e.g. a sweep). The effect of the command is the same as with that of a pulse at the external trigger signal input.
&LLO	Local Lockout	Disables switchover from remote control to manual control by means of the front panel keys.
&NREN	Not Remote Enable	Enables switchover from remote control to manual operation by means of the front panel keys
&POL	Serial Poll	Starts a serial poll.

6.1.4 USB Interface

For remote control via the USB connection, the PC and the instrument must be connected via the USB type B interface. A USB connection requires the VISA library to be installed. VISA detects and configures the R&S instrument automatically when the USB connection is established. You do not have to enter an address string or install a separate driver.

USB address

The used USB address string is:

```
USB::::<product ID>::::[::INSTR]
```

where:

- <vendor ID> is the vendor ID for Rohde&Schwarz
- <product ID> is the product ID for the R&S instrument
- <serial number> is the individual serial number on the rear of the instrument

Example:

```
USB::0x0AAD::0x0047::100001::INSTR
```

0x0AAD is the vendor ID for Rohde&Schwarz

0x47 is the product ID for the R&S SMF

100001 is the serial number of the particular instrument

6.1.5 Serial Interface

Remote control via the serial interface is possible either via RS232 interface or via a Bluetooth connection. The controller/Bluetooth device and the instrument must be con-

nected via an external USB/serial-adaptor (see recommended extras, data sheet) and a serial crossover (null modem) cable. A USB connection requires the VISA library to be installed on the controller. VISA will detect and configure the R&S SMF automatically when the USB connection is established.

Serial address

The used serial address string is:

```
ASRL[0-9] [ : : INSTR ]
```

where ASRL[0-9] determines the number of the COM port on the controller side, that has to be used for the serial connection.

Access via a bluetooth device requires the entry of the bluetooth pin in addition (see [chapter 5.2.3.15, "Security"](#), on page 107).

To enable an error-free and correct data transmission, the parameters of the generator and the controller must have the same setting. The serial interface is preset for a baud rate 115200, no parity and one stop bit. The parameters can be manually changed in "Remote Channel Settings" dialog (see [chapter 5.2.3.13, "Remote Channel Settings"](#), on page 104).

6.1.6 GPIB Interface (IEC/IEEE Bus Interface)

To be able to control the instrument via the GPIB bus, the instrument and the controller must be linked by a GPIB bus cable. A GPIB bus card, the card drivers and the program libraries for the programming language used must be provided in the controller. The controller must address the instrument with the GPIB bus address (see [chapter 6.1.6.2, "GPIB Instrument Address"](#), on page 271).

Characteristics

The GPIB interface is described by the following characteristics:

- Up to 15 instruments can be connected
- The total cable length is restricted to a maximum of 15 m; the cable length between two instruments should not exceed 2m.
- A wired "OR"-connection is used if several instruments are connected in parallel, since the slowest instrument determines the speed.



Any connected IEC bus cable must be terminated by an instrument or controller.

6.1.6.1 GPIB Interface Messages

Interface messages are transmitted to the instrument on the data lines, with the attention line (ATN) being active (LOW). They are used for communication between the controller and the instrument and can only be sent by a computer which has the function of a GPIB bus controller. GPIB interface messages can be further subdivided into:

- **Universal commands:** act on all instruments connected to the GPIB bus without previous addressing
- **Addressed commands:** only act on instruments previously addressed as listeners

Universal Commands

Universal commands are encoded in the range 10 through 1F hex. They affect all instruments connected to the bus and do not require addressing.

Command	Effect on the instrument
DCL (Device Clear)	Aborts the processing of the commands just received and sets the command processing software to a defined initial state. Does not change the instrument settings.
IFC (Interface Clear) *)	Resets the interfaces to the default setting.
LLO (Local Lockout)	The LOC/IEC ADDR key is disabled.
SPE (Serial Poll Enable)	Ready for serial poll.
SPD (Serial Poll Disable)	End of serial poll.
PPU (Parallel Poll Unconfigure)	End of the parallel-poll state.
*) IFC is not a real universal command, it is sent via a separate line; however, it also affects all instruments connected to the bus and does not require addressing	

Addressed Commands

Addressed commands are encoded in the range 00 through 0F hex. They only affect instruments addressed as listeners.

Command	Effect on the instrument
GET (Group Execute Trigger)	Triggers a previously active instrument function (e.g. a sweep). The effect of the command is the same as with that of a pulse at the external trigger signal input.
GTL (Go to Local)	Transition to the "local" state (manual control).
GTR (Go to Remote)	Transition to the "remote" state (remote control).
PPC (Parallel Poll Configure)	Configures the instrument for parallel poll.
SDC (Selected Device Clear)	Aborts the processing of the commands just received and sets the command processing software to a defined initial state. Does not change the instrument setting.

6.1.6.2 GPIB Instrument Address

In order to operate the instrument via remote control, it must be addressed using the GPIB address. The remote control address is factory preset, but it can be changed if it does not fit in the network environment. For remote control, addresses 0 through 30 are allowed. The GPIB address is maintained after a reset of the instrument settings.

Changing the GPIB address of the instrument

The GPIB address can be changed manually or using a remote control command.

1. Manually: press the SETUP key and select "Remote > GPIB".

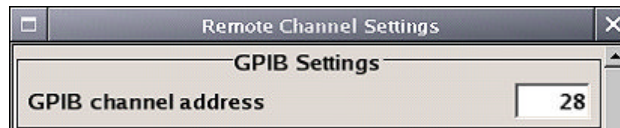

Select parameter "GPIB channel address" and set the GPIB address.

2. Using remote control command:

```
SYST:COMM:GPIB:ADDR 18
```

6.2 Starting a Remote Control Session

The instrument and the controller have to be connected with the suitable cable and switched on.

A remote control program must open a connection to the instrument (using VISA functionality), before it can send commands to and receive device responses from the instrument.



Instrument Address

In order to operate the instrument via remote control it must be addressed using the defined interface address. See [chapter 6.1.3, "LAN Interface"](#), on page 267, [chapter 6.1.4, "USB Interface"](#), on page 269, [chapter 6.1.5, "Serial Interface"](#), on page 269 or [chapter 6.1.6, "GPIB Interface \(IEC/IEEE Bus Interface\)"](#), on page 270 for details.



The VISA resource strings are indicated in the "Setup > Remote Channel Settings" menu.

Refer to [chapter 6.2.3, "Examples"](#), on page 273 for practical examples on setting up of a remote control link and starting of a remote control session.

6.2.1 Switching to Remote Control

When it is switched on, the instrument is always in the manual operating state and can be operated via the front panel controls (for instruments equipped with a display) or via mouse and external keyboard.

Starting remote control

1. Send a command from a controller to the instrument.

The instrument is switched to remote control as soon as it receives a command from the controller.

While remote control is active, operation via the front panel or via mouse and keyboard is disabled and "REMOTE" is displayed in the status line.

The instrument remains in the remote state until it is reset to the manual state via the instrument or via the remote control interface (see [chapter 6.2.2, "Returning to Manual Operation"](#), on page 273).

Tip: Switching from manual operation to remote control and vice versa does not affect the other instrument settings.

2. Although operation via front panel, mouse and keyboard is disabled, the dialog boxes can still be opened, e.g. to verify settings, but buttons and setting fields are displayed in gray and cannot be activated.

Use the command `SYST:KLOC ON` to disable the access to the dialogs.

3. To prevent unintentional return to manual operation, disable the LOCAL key of the instrument using the `&LLO` command (see [chapter 6.1.3.3, "LAN Interface Messages"](#), on page 268).

The instrument switches to "REM-LLO" state and transition to manual mode is not anymore possible via the remote control command `*GTL`.

Switching to manual mode is only possible via remote control then.

4. Enable the LOCAL key with the interface message `&NREN`.

6.2.2 Returning to Manual Operation



Before returning to manual control, command processing must be completed. Otherwise, the instrument switches back to remote control immediately.

- ▶ To return to manual operation, use one of the following ways:
 - a) Press the LOCAL key on the front panel.
 - b) Select "Setup > Remote Control Channels" and press "Local".
 - c) While using the socket communication, terminate the remote control session.
 - d) Send the interface command `>L` via the remote control interface.

Tip: Use the `&NREN` to enable the LOCAL key if the key is disabled.

6.2.3 Examples

This sections provides examples for setting up of remote control connection and starting a remote control session over LAN and GPIB interfaces.

This section assumes basic knowledge of programming and operation of the controller. A description of the interface commands can be obtained from the relevant manuals.

6.2.3.1 Remote Control over GPIB

The program example in this section is written in VISUAL BASIC. A condition for programming in VISUAL BASIC is that the modules NIGLOBAL (Niglobal.bas) and VBIB32 (Vbib_32.bas) are added to the projects.



Drivers for instrument, e.g. IVI-COM and LabVIEW drivers, are available in the download area of the product website (http://www2.rohde-schwarz.com/en/products/test_and_measurement/product_categories/signal_generation/).

Starting a remote control session over GPIB

As a prerequisite, the GPIB address of the instrument, which is factory-set to 28, must not have been changed.

1. Connect instrument and controller using GPIB cable and switch them on.
2. Execute following commands on the controller:
 - a) Open port to the instrument
`CALL IBFIND("DEV1", generator%)`
 - b) Inform controller about instrument address
`CALL IBPAD(generator%, 28)`
 - c) Reset instrument
`CALL IBWRT(generator%, "*RST;*CLS")`
 - d) Set instrument to new address
`CALL IBWRT(generator%, "SYST:COMM:GPIB:ADDR 18")`
 - e) Inform controller about new address
`CALL IBPAD(generator%, 18)`

The GPIB address of the instrument is changed.

3. To return to manual operation, press the LOCAL key at the front panel.

6.2.3.2 Remote Control over LAN using VXI-11 Protocol

Through the examples in this section, the program 'Measurement & Automation Explorer' from National Instruments under Windows operating system is used for setting up a LAN remote control link and starting a remote control session.

Configuring the controller



The instrument is preconfigured for networks using DHCP (dynamic host configuration protocol). If this configuration is used, enter the computer name in the position of the IP address.

To enable the external controller to communicate with the software via TCP/IP protocol, set up a remote control link as follow:

1. Connect the controller and the instrument to the network (network cable) and switch them on.
2. Start the 'Measurement & Automation Control' program on the controller.
3. Select "Devices and Interfaces > Create New".



4. Select "VISA TCP/IP Resource" and confirm with "Next".

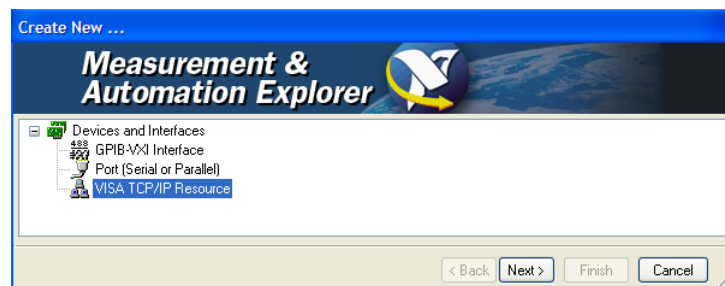

5. Choose the type of TCP/IP resource you wish to add and select Next.

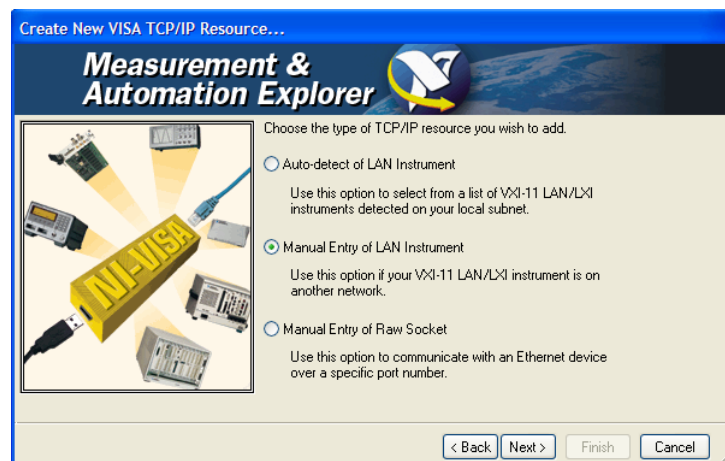

6. Enter the IP address or the host name of the R&S SMF and select "Next".

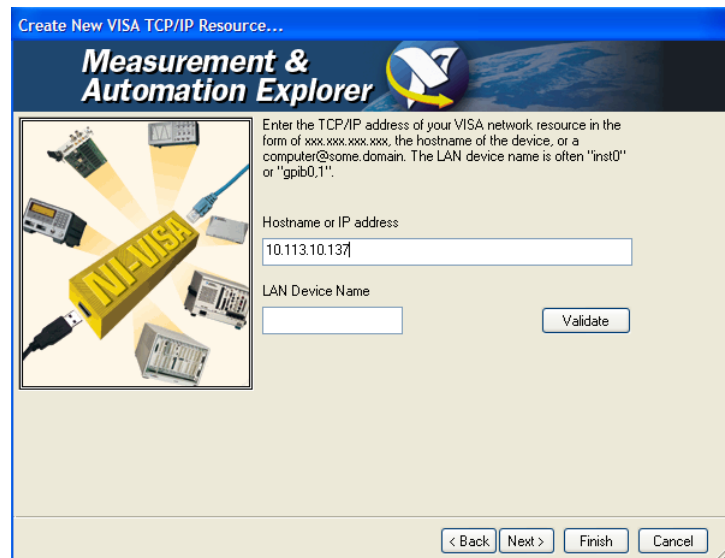

7. Enter the alias name if required.
The alias name must not be mistaken for the computer name. It is only used for instrument identification within the program and displayed in the menu as an option in case of an Ethernet link.
8. Confirm the settings with "Finish".
The instrument is configured and the settings are displayed in the "TCP/IP Settings" tab.

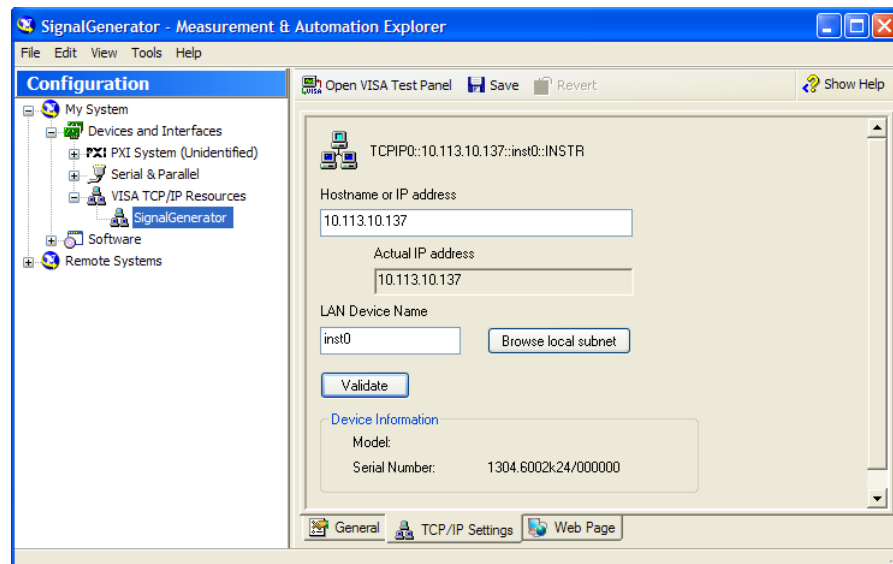

9. To test the connection, select "Validate".
A message indicates whether the link to the instrument can be set up or not.

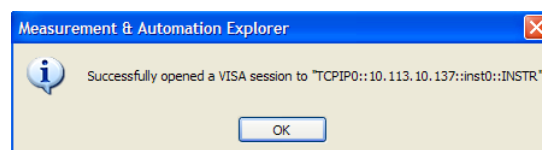

If a connection cannot be set up, check whether the controller and the instrument are connected to the network (network cable) and switched on. Correct spelling of the IP address or the computer name can also be checked. For further error location, inform the network administrator. In large networks, specification of additional addresses may be required for link setup, e.g. gateway and subnet mask, which are known to the network administrator.

The instrument is now registered in the program and can be addressed via the resource string or alias name.

Starting a remote control over LAN (using VXI-11)

1. Start the 'Measurement & Automation Explorer' on the controller.
2. In the "Configuration" window, select "Device and Interfaces > VISA TCP/IP Resources", select the required instrument and select "Open VISA Test Panel".

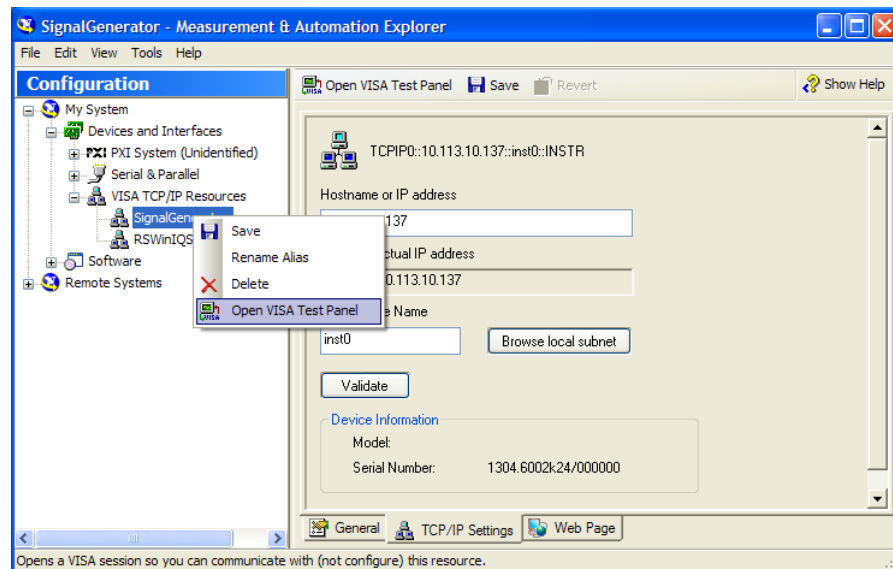

3. In the "viWrite" tab, write the command to be send to the instrument and select "Execute".

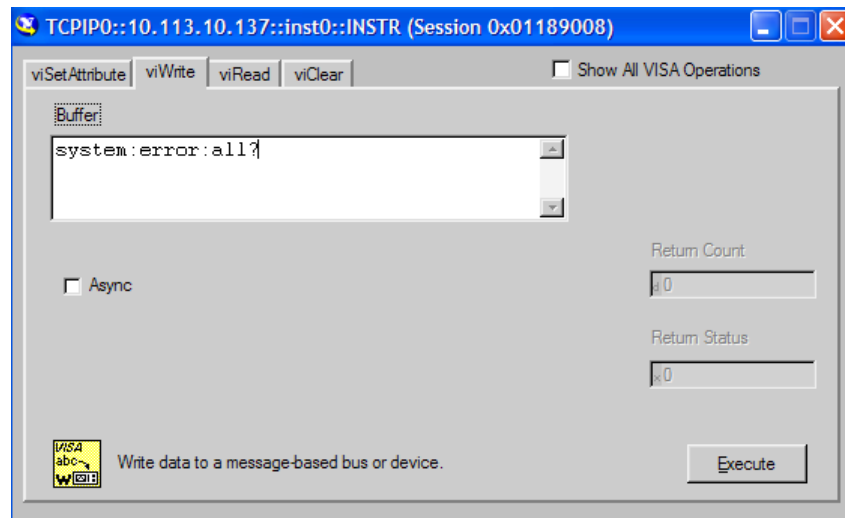

Instrument responses are displayed on the "viRead" tab.

Tip: For further program operation refer to the online help of the program.

6.2.3.3 Remote Control over LAN using Socket Communication

This chapter provides an example on how to establish a remote control connection over telnet protocol and a simple sockets-based program example that can be further developed.

Setting up a Telnet Connection

To control the software, only a telnet program is required. The telnet program is part of every operating system.

1. To establish a Telnet connection with the R&S SMF, start the telnet program and enter the socket address.

The socket address is a combination of the IP address or the host name of the R&S SMF and the number of the port configured for remote-control via telnet.

Tip: The R&S SMF uses the port number 5025 for remote connection via Telnet.

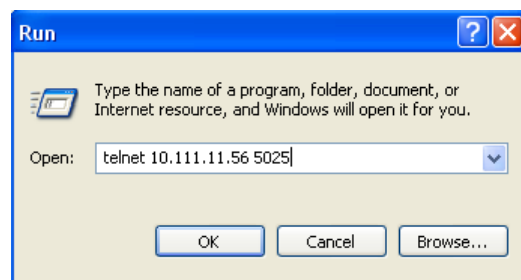

The connection to the instrument is set up and remote-control commands can be sent.

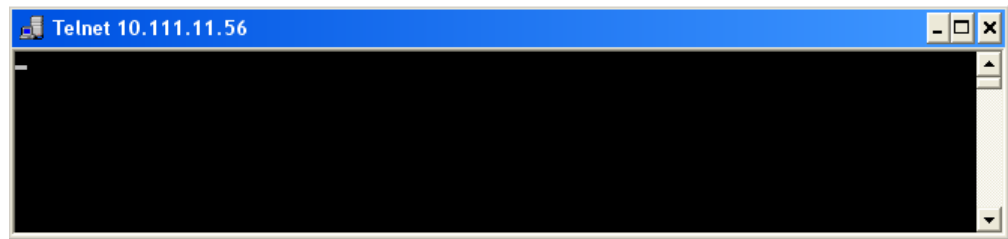

2. Even if the cursor is not visible on the screen, enter blind a remote-control command and confirm with Enter.

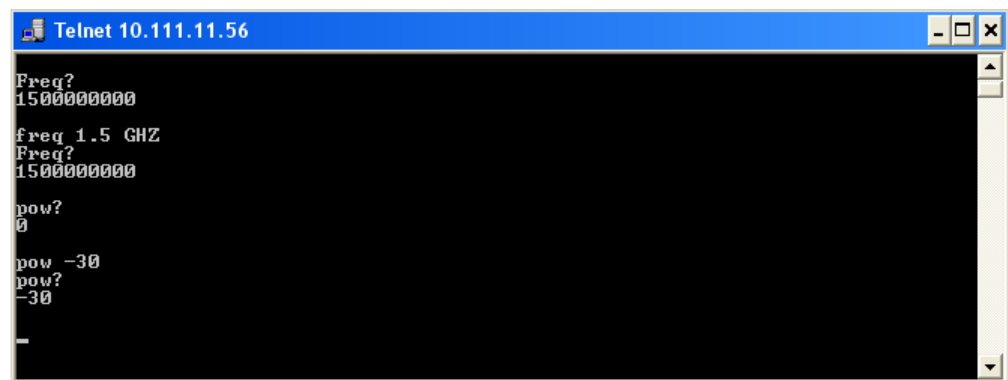

After the first remote-control command had been send, the instrument is in the "REMOTE" state, i.e. instrument control from the front panel or via mouse and keyboard is disabled and "REMOTE" is displayed in the status line.

Telnet program examples

The following program example shows a simple TcpClient class that is intended to explain on how to get started with programming of sockets.

The example sets up a socket communication to R&S SMF and opens a simple user interface, very similar to the telnet, which allows input of commands. To enable real automation, further development of the program is required.

TcpClient.h

```
#include <string>
//defines structs for socket handling
#include <netinet/in.h>
using namespace std;
typedef struct sockaddr_in SockAddrStruct;
typedef struct hostent      HostInfoStruct;
class TcpClient
{
public:
    TcpClient();
    ~TcpClient();
    void connectToServer( string &hostname, int port );
    void disconnect( );
    void transmit( string &txString );
};
```



```

void receive( string &rxString );
string getCurrentHostName( ) const;
int    getCurrentPort( ) const;
private:
string      currentHostName;
int         currentPort;
int         currentSocketDescr;
SockAddrStruct  serverAddress;
HostInfoStruct * currentHostInfo;
bool        clientIsConnected;
int         receiveBufferSize;
};

```

TcpClient.cpp

```

#include <string>
//defines structs for socket handling
#include <netinet/in.h>
using namespace std;
typedef struct sockaddr_in SockAddrStruct;
typedef struct hostent     HostInfoStruct;
class TcpClient
{
public:
    TcpClient();
    ~TcpClient();
    void connectToServer( string &hostname, int port );
    void disconnect( );
    void transmit( string &txString );
    void receive( string &rxString );
    string getCurrentHostName( ) const;
    int    getCurrentPort( ) const;
private:
    string      currentHostName;
    int         currentPort;
    int         currentSocketDescr;
    SockAddrStruct  serverAddress;
    HostInfoStruct * currentHostInfo;
    bool        clientIsConnected;
    int         receiveBufferSize;
};

#include <netdb.h>
#include <netinet/in.h>
#include <unistd.h>
#include "TcpClient.h"
TcpClient::TcpClient()
: currentHostName( "" )
, currentPort( 0 )
, currentSocketDescr( 0 )

```

```

, serverAddress ( )
, currentHostInfo( NULL )
, clientIsConnected( false )
, receiveBufferSize( 1024 )
{
}
}
TcpClient::~TcpClient()
{
    currentHostInfo = NULL;
}

void TcpClient::connectToServer( string &hostname, int port )
{
    currentHostInfo = gethostbyname( hostname.c_str( ) );
    if( currentHostInfo == NULL )
    {
        currentHostName = "";
        currentPort = 0;
        currentHostInfo = NULL;
        clientIsConnected = false;
        printf("error connecting host\n" );
    }
    currentHostName = hostname;
    currentPort = port;
    currentSocketDescr = socket(AF_INET, SOCK_STREAM, 0);
    if( currentSocketDescr == 0 )
    {
        currentHostName = "";
        currentPort = 0;
        currentHostInfo = NULL;
        clientIsConnected = false;
        printf("can't create socket\n" );
    }
    serverAddress.sin_family = currentHostInfo->h_addrtype;
    serverAddress.sin_port = htons( currentPort );
    memcpy( (char *) &serverAddress.sin_addr.s_addr,
        currentHostInfo->h_addr_list[0], currentHostInfo->h_length );
    if( connect( currentSocketDescr, ( struct sockaddr *) &serverAddress,
        sizeof( serverAddress ) ) < 0 )
    {
        throw string("can't connect server\n" );
    }
    clientIsConnected = true;
}

void TcpClient::disconnect( )
{
    if( clientIsConnected )
    {
        close( currentSocketDescr );
    }
}

```

```
    currentSocketDescr = 0;
    currentHostName    = "";
    currentPort        = 0;
    currentHostInfo    = NULL;
    clientIsConnected = false;
}

void TcpClient::transmit( string &txString )
{
    if( !clientIsConnected )
    {
        throw string("connection must be established before any data can be sent\n");
    }
    char * transmitBuffer = new char[txString.length() +1];
    memcpy( transmitBuffer, txString.c_str(), txString.length() );
    transmitBuffer[txString.length()] = '\n'; //newline is needed!
    if( send( currentSocketDescr, transmitBuffer, txString.length() + 1, 0 ) < 0 )
    {
        throw string("can't transmit data\n");
    }
    delete [] transmitBuffer;
}

void TcpClient::receive( string &rxString )
{
    if( !clientIsConnected )
    {
        throw string("connection must be established before any data can be received\n");
    }
    char * receiveBuffer = new char[receiveBufferSize];
    memset( receiveBuffer, 0, receiveBufferSize );
    bool receiving = true;
    while( receiving )
    {
        int receivedByteCount = recv( currentSocketDescr,
            receiveBuffer, receiveBufferSize, 0 );
        if( receivedByteCount < 0 )
        {
            throw string("error while receiving data\n");
        }
        rxString += string( receiveBuffer );
        receiving = ( receivedByteCount == receiveBufferSize );
    }
    delete [] receiveBuffer;
}

string TcpClient::getCurrentHostName( ) const
{
    return currentHostName;
}

int TcpClient::getCurrentPort( ) const
{

```

```

    return currentPort;
}

```

TelnetClient.cpp

```

#include <iostream>
#include "TcpClient.h"
void printUsage()
{
    cout<<"usage: EthernetRawCommand <server-ip> [scpi-command]"<<endl;
}
int main( int argc, char *argv[] )
{
    int errorCode          = 0; //no error
    bool useSingleCommand = false;
    string singleCommand  = "";
    string hostname       = "";
    int    port           = 5025;
    string input          = "";
    TcpClient client;
    switch( argc )
    {
        case 3:
            useSingleCommand = true;
            singleCommand    = argv[2];
        case 2:
            hostname         = argv[1];
            break;
        default:
            printUsage();
            return(-1);
    }
    try
    {
        client.connectToServer( hostname, port );
        bool terminate = false;
        while( !terminate )
        {
            char buffer[1024];
            if( useSingleCommand )
            {
                input = singleCommand; //send string
            }
            else
            {
                cin.getline( buffer, 1024 );
                input = buffer;
                if( input == "end" )
                {
                    terminate = true;
                }
            }
        }
    }
}

```

```

    }
}
if( !terminate)
{
    client.transmit( input ); //send string
    int qPos = input.find( "?", 0 );
    //receive string only when needed
    if( qPos > 0 )
    {
        string rcStr = "";
        client.receive( rcStr );
        cout << rcStr << endl;
    }
}
if( useSingleCommand )
{
    terminate = true;
}
}
}catch( const string errorString )
{
    cout<<errorString<<endl;
}
client.disconnect( );
return errorCode;
}

```

6.3 SCPI Command Structure

SCPI commands consist of a so-called header and, in most cases, one or more parameters. The header and the parameters are separated by a "white space" (ASCII code 0 to 9, 11 to 32 decimal, e.g. blank). The headers may consist of several mnemonics (key-words). Queries are formed by appending a question mark directly to the header.

The commands can be either device-specific or device-independent (common commands). Common and device-specific commands differ in their syntax.

6.3.1 Syntax for Common Commands

Common (=device-independent) commands consist of a header preceded by an asterisk (*) and possibly one or more parameters.

Examples:

*RST	RESET	Resets the instrument.
*ESE	EVENT STATUS ENABLE	Sets the bits of the event status enable registers.

*ESR?	EVENT STATUS QUERY	Queries the contents of the event status register.
*IDN?	IDENTIFICATION QUERY	Queries the instrument identification string.

6.3.2 Syntax for Device-Specific Commands



Not all commands used in the following examples are necessarily implemented in the instrument.

For demonstration purposes only, assume the existence of the following commands for this section:

- DISPLAY[:WINDow<1...4>]:MAXimize <Boolean>
- FORMat:READings:DATA <type>[,<length>]
- HCOpy:DEvice:COLor <Boolean>
- HCOpy:DEvice:CMAP:COLor:RGB <red>,<green>,<blue>
- HCOpy[:IMMediate]
- HCOpy:ITEM:ALL
- HCOpy:ITEM:LABel <string>
- HCOpy:PAGE:DIMensions:QUADrant [<N>]
- HCOpy:PAGE:ORientation LANDscape | PORTrait
- HCOpy:PAGE:SCALE <numeric value>
- MMEMory:COpy <file_source>,<file_destination>
- SENSE:BANDwidth|BWIDth[:RESolution] <numeric_value>
- SENSE:FREQuency:STOP <numeric value>
- SENSE:LIST:FREQuency <numeric_value>{,<numeric_value>}

Long and short form

The mnemonics feature a long form and a short form. The short form is marked by upper case letters, the long form corresponds to the complete word. Either the short form or the long form can be entered; other abbreviations are not permitted.

Example:

HCOpy:DEvice:COLor ON is equivalent to HCOP:DEV:COL ON.



Case-insensitivity

Upper case and lower case notation only serves to distinguish the two forms in the manual, the instrument itself is case-insensitive.

Numeric suffixes

If a command can be applied to multiple instances of an object, e.g. specific channels or sources, the required instances can be specified by a suffix added to the command. Numeric suffixes are indicated by angular brackets (<1...4>, <n>, <i>) and are replaced by a single value in the command. Entries without a suffix are interpreted as having the suffix 1.

Example:

Definition: `HCOPY:PAGE:DIMensions:QUADrant [<N>]`

Command: `HCOPY:PAGE:DIM:QUAD2`

This command refers to the quadrant 2.



Different numbering in remote control

For remote control, the suffix may differ from the number of the corresponding selection used in manual operation. SCPI prescribes that suffix counting starts with 1. Suffix 1 is the default state and used when no specific suffix is specified.

Some standards define a fixed numbering, starting with 0. If the numbering differs in manual operation and remote control, it is indicated for the corresponding command.

Optional mnemonics

Some command systems permit certain mnemonics to be inserted into the header or omitted. These mnemonics are marked by square brackets in the description. The instrument must recognize the long command to comply with the SCPI standard. Some commands are considerably shortened by these optional mnemonics.

Example:

Definition: `HCOPY[:IMMEDIATE]`

Command: `HCOPY:IMM` is equivalent to `HCOPY`



Optional mnemonics with numeric suffixes

Do not omit an optional mnemonic if it includes a numeric suffix that is relevant for the effect of the command.

Example:

Definition: `DISPLAY[:WINDOW<1...4>]:MAXimize <Boolean>`

Command: `DISP:MAX ON` refers to window 1.

In order to refer to a window other than 1, you must include the optional `WINDOW` parameter with the suffix for the required window.

`DISP:WIND2:MAX ON` refers to window 2.

Parameters

Parameters must be separated from the header by a "white space". If several parameters are specified in a command, they are separated by a comma (,). For a description of the parameter types, refer to [chapter 6.3.3, "SCPI Parameters"](#), on page 287.

Example:

Definition:HCOPy:DEVice:CMAP:COLor:RGB <red>, <green>, <blue>

Command:HCOP:DEV:CMAP:COL:RGB 3, 32, 44

Special characters

	<p>Parameters</p> <p>A vertical stroke in parameter definitions indicates alternative possibilities in the sense of "or". The effect of the command differs, depending on which parameter is used.</p> <p>Example:</p> <p>Definition:HCOPy:PAGE:ORIENTATION LANDscape PORTRait</p> <p>Command HCOP:PAGE:ORI LAND specifies landscape orientation</p> <p>Command HCOP:PAGE:ORI PORT specifies portrait orientation</p> <p>Mnemonics</p> <p>A selection of mnemonics with an identical effect exists for several commands. These mnemonics are indicated in the same line; they are separated by a vertical stroke. Only one of these mnemonics needs to be included in the header of the command. The effect of the command is independent of which of the mnemonics is used.</p> <p>Example:</p> <p>DefinitionSENSE:BANDwidth BWIDth[:RESolution] <numeric_value></p> <p>The two following commands with identical meaning can be created:</p> <p>SENS:BAND:RES 1</p> <p>SENS:BWID:RES 1</p>
[]	<p>Mnemonics in square brackets are optional and may be inserted into the header or omitted.</p> <p>Example: HCOPy[:IMMEDIATE]</p> <p>HCOP:IMM is equivalent to HCOP</p>
{ }	<p>Parameters in curly brackets are optional and can be inserted once or several times, or omitted.</p> <p>Example: SENSE:LIST:FREQuency <numeric_value>{,<numeric_value>}</p> <p>The following are valid commands:</p> <p>SENS:LIST:FREQ 10</p> <p>SENS:LIST:FREQ 10,20</p> <p>SENS:LIST:FREQ 10,20,30,40</p>

6.3.3 SCPI Parameters

Many commands are supplemented by a parameter or a list of parameters. The parameters must be separated from the header by a "white space" (ASCII code 0 to 9, 11 to 32 decimal, e.g. blank). Allowed parameters are:

- Numeric values

- Special numeric values
- Boolean parameters
- Text
- Character strings
- Block data

The parameters required for each command and the allowed range of values are specified in the command description.

Numeric values

Numeric values can be entered in any form, i.e. with sign, decimal point and exponent. Values exceeding the resolution of the instrument are rounded up or down. The mantissa may comprise up to 255 characters, the exponent must lie inside the value range -32000 to 32000. The exponent is introduced by an "E" or "e". Entry of the exponent alone is not allowed. In the case of physical quantities, the unit can be entered. Allowed unit prefixes are G (giga), MA (mega), MOHM and MHZ are also allowed), K (kilo), M (milli), U (micro) and N (nano). If the unit is missing, the basic unit is used.

Example: `SENS:FREQ:STOP 1.5GHz = SENS:FREQ:STOP 1.5E9`

Units

For physical quantities, the unit can be entered. Allowed unit prefixes are:

- G (giga)
- MA (mega), MOHM, MHZ
- K (kilo)
- M (milli)
- U (micro)
- N (nano)

If the unit is missing, the basic unit is used.

Example:

`SENSe:FREQ:STOP 1.5GHz = SENSe:FREQ:STOP 1.5E9`

Some settings allow relative values to be stated in percent. According to SCPI, this unit is represented by the `PCT` string.

Example:

`HCOP:PAGE:SCAL 90PCT`

Special numeric values

The texts listed below are interpreted as special numeric values. In the case of a query, the numeric value is provided.

- **MIN/MAX**
MINimum and MAXimum denote the minimum and maximum value.

- **DEF**
DEFault denotes a preset value which has been stored in the EPROM. This value conforms to the default setting, as it is called by the *RST command.
- **UP/DOWN**
UP, DOWN increases or reduces the numeric value by one step. The step width can be specified via an allocated step command for each parameter which can be set via UP, DOWN.
- **INF/NINF**
INFinity, Negative INFinity (NINF) represent the numeric values 9.9E37 or -9.9E37, respectively. INF and NINF are only sent as instrument responses.
- **NAN**
Not A Number (NAN) represents the value 9.91E37. NAN is only sent as a instrument response. This value is not defined. Possible causes are the division of zero by zero, the subtraction of infinite from infinite and the representation of missing values.

Example:

Setting command: `SENSe:LIST:FREQ MAXimum`

Query: `SENS:LIST:FREQ?`, Response: `3.5E9`

**Queries for special numeric values**

The numeric values associated to `MAXimum`/`MINimum`/`DEFault` can be queried by adding the corresponding mnemonics to the command. They must be entered following the quotation mark.

Example: `SENSe:LIST:FREQ? MAXimum`

Returns the maximum numeric value as a result.

Boolean Parameters

Boolean parameters represent two states. The "ON" state (logically true) is represented by "ON" or a numeric value 1. The "OFF" state (logically untrue) is represented by "OFF" or the numeric value 0. The numeric values are provided as the response for a query.

Example:

Setting command: `HCOPY:DEV:COL ON`

Query: `HCOPY:DEV:COL?`

Response: `1`

Text parameters

Text parameters observe the syntactic rules for mnemonics, i.e. they can be entered using a short or long form. Like any parameter, they have to be separated from the header by a white space. In the case of a query, the short form of the text is provided.

Example:

Setting command: `HCOPY:PAGE:ORIENTATION LANDscape`

Query: `HCOPY:PAGE:ORI?`

Response: `LAND`

Character strings

Strings must always be entered in quotation marks (' or ").

Example:

`HCOPY:ITEM:LABEL "Test1"` or `HCOPY:ITEM:LABEL 'Test1'`

Block data

Block data is a format which is suitable for the transmission of large amounts of data. A command using a block data parameter has the following structure:

Example:

`FORMAt:READings:DATA #45168xxxxxxxx`

The ASCII character # introduces the data block. The next number indicates how many of the following digits describe the length of the data block. In the example the 4 following digits indicate the length to be 5168 bytes. The data bytes follow. During the transmission of these data bytes all end or other control signs are ignored until all bytes are transmitted. #0 specifies a data block of indefinite length. The use of the indefinite format requires a `NL^END` message to terminate the data block. This format is useful when the length of the transmission is not known or if speed or other considerations prevent segmentation of the data into blocks of definite length.

6.3.4 Overview of Syntax Elements

The following table provides an overview of the syntax elements:

:	The colon separates the mnemonics of a command. In a command line the separating semicolon marks the uppermost command level.
;	The semicolon separates two commands of a command line. It does not alter the path.
,	The comma separates several parameters of a command.
?	The question mark forms a query.
*	The asterisk marks a common command.
' '	Quotation marks introduce a string and terminate it (both single and double quotation marks are possible).

#	The hash symbol introduces binary, octal, hexadecimal and block data. <ul style="list-style-type: none"> • Binary: #B10110 • Octal: #O7612 • Hexa: #HF3A7 • Block: #21312
	A "white space" (ASCII-Code 0 to 9, 11 to 32 decimal, e.g. blank) separates the header from the parameters.

6.3.5 Structure of a command line

A command line may consist of one or several commands. It is terminated by one of the following:

- a <New Line>
- a <New Line> with EOI
- an EOI together with the last data byte

Several commands in a command line must be separated by a semicolon ";". If the next command belongs to a different command system, the semicolon is followed by a colon.

Example:

```
MMEM: COPY "Test1", "MeasurementXY"; :HCOP: ITEM ALL
```

This command line contains two commands. The first command belongs to the MMEM system, the second command belongs to the HCOP system.

If the successive commands belong to the same system, having one or several levels in common, the command line can be abbreviated. To this end, the second command after the semicolon starts with the level that lies below the common levels. The colon following the semicolon must be omitted in this case.

Example:

```
HCOP: ITEM ALL; :HCOP: IMM
```

This command line contains two commands. Both commands are part of the HCOP command system, i.e. they have one level in common.

When abbreviating the command line, the second command begins with the level below HCOP. The colon after the semicolon is omitted. The abbreviated form of the command line reads as follows:

```
HCOP: ITEM ALL; IMM
```

A new command line always begins with the complete path.

Example:

```
HCOP: ITEM ALL
```

```
HCOP: IMM
```

6.3.6 Responses to Queries

A query is defined for each setting command unless explicitly specified otherwise. It is formed by adding a question mark to the associated setting command. According to SCPI, the responses to queries are partly subject to stricter rules than in standard IEEE 488.2.

- The requested parameter is transmitted without a header.
Example: `HCOP:PAGE:ORI?`, **Response:** `LAND`
- Maximum values, minimum values and all other quantities that are requested via a special text parameter are returned as numeric values.
Example: `SENSe:FREQuency:STOP? MAX`, **Response:** `3.5E9`
- Numeric values are output without a unit. Physical quantities are referred to the basic units or to the units set using the `Unit` command. The response `3.5E9` in the previous example stands for 3.5 GHz.
- Truth values (Boolean values) are returned as 0 (for OFF) and 1 (for ON).
Example:
Setting command: `HCOPy:DEV:COL ON`
Query: `HCOPy:DEV:COL?`
Response: `1`
- Text (character data) is returned in a short form.
Example:
Setting command: `HCOPy:PAGE:ORIENTATION LANDscape`
Query: `HCOP:PAGE:ORI?`
Response: `LAND`

6.4 Command Sequence and Synchronization

IEEE 488.2 defines a distinction between overlapped and sequential commands:

- A sequential command is one which finishes executing before the next command starts executing. Commands that are processed quickly are usually implemented as sequential commands. Sequential commands are not implemented in the instrument, however the execution time of most commands is so short that they act as sequential commands when sent in different command lines.
- An overlapping command is one which does not automatically finish executing before the next command starts executing. Usually, overlapping commands take longer to process and allow the program to do other tasks while being executed. If overlapping commands do have to be executed in a defined order, e.g. in order to avoid wrong measurement results, they must be serviced sequentially. This is called synchronization between the controller and the instrument.

Setting commands within one command line, even though they may be implemented as sequential commands, are not necessarily serviced in the order in which they have been received. In order to make sure that commands are actually carried out in a certain order, each command must be sent in a separate command line.

Example: Commands and queries in one message

The response to a query combined in a program message with commands that affect the queried value is not predictable.

The following commands always return the specified result:

```
:FREQ:STAR 1GHZ;SPAN 100 :FREQ:STAR?
```

Result:

```
1000000000 (1 GHz)
```

Whereas the result for the following commands is not specified by SCPI:

```
:FREQ:STAR 1GHz;STAR?;SPAN 1000000
```

The result could be the value of `START` before the command was sent since the instrument might defer executing the individual commands until a program message terminator is received. The result could also be 1 GHz if the instrument executes commands as they are received.



As a general rule, send commands and queries in different program messages.

Example: Overlapping command with *OPC

The instrument implements `INITiate[:IMMEDIATE]` as an overlapped command.

Assuming that `INITiate[:IMMEDIATE]` takes longer to execute than `*OPC`, sending the following command sequence results in initiating a sweep and, after some time, setting the `OPC` bit in the `ESR`:

```
INIT; *OPC.
```

Sending the following commands still initiates a sweep:

```
INIT; *OPC; *CLS
```

However, since the operation is still pending when the instrument executes `*CLS`, forcing it into the "Operation Complete Command Idle" State (OCIS), `*OPC` is effectively skipped. The `OPC` bit is not set until the instrument executes another `*OPC` command.

6.4.1 Preventing Overlapping Execution

To prevent an overlapping execution of commands, one of the commands `*OPC`, `*OPC?` or `*WAI` can be used. All three commands cause a certain action only to be carried out after the hardware has been set. By suitable programming, the controller can be forced to wait for the corresponding action to occur.

Table 6-2: Synchronization using *OPC, *OPC? and *WAI

Command	Action	Programming the controller
*OPC	Sets the Operation Complete bit in the ESR after all previous commands have been executed.	<ul style="list-style-type: none"> Setting bit 0 in the ESE Setting bit 5 in the SRE Waiting for service request (SRQ)
*OPC?	Stops command processing until 1 is returned. This is only the case after the Operation Complete bit has been set in the ESR. This bit indicates that the previous setting has been completed.	Sending *OPC? directly after the command whose processing should be terminated before other commands can be executed.
*WAI	Stops further command processing until all commands sent before *WAI have been executed.	Sending *WAI directly after the command whose processing should be terminated before other commands are executed.

Command synchronization using *WAI or *OPC? appended to an overlapped command is a good choice if the overlapped command takes only little time to process. The two synchronization techniques simply block overlapped execution of the command.

For time consuming overlapped commands it is usually desirable to allow the controller or the instrument to do other useful work while waiting for command execution. Use one of the following methods:

***OPC with a service request**

1. Set the OPC mask bit (bit no. 0) in the ESE: *ESE 1
2. Set bit no. 5 in the SRE: *SRE 32 to enable ESB service request.
3. Send the overlapped command with *OPC
4. Wait for a service request

The service request indicates that the overlapped command has finished.

***OPC? with a service request**

1. Set bit no. 4 in the SRE: *SRE 16 to enable MAV service request.
2. Send the overlapped command with *OPC?
3. Wait for a service request

The service request indicates that the overlapped command has finished.

Event Status Register (ESE)

1. Set the OPC mask bit (bit no. 0) in the ESE: *ESE 1
2. Send the overlapped command without *OPC, *OPC? or *WAI
3. Poll the operation complete state periodically (by means of a timer) using the sequence: *OPC; *ESR?

A return value (LSB) of 1 indicates that the overlapped command has finished.

***OPC? with short timeout**

1. Send the overlapped command without *OPC, *OPC? or *WAI
2. Poll the operation complete state periodically (by means of a timer) using the sequence: <short timeout>; *OPC?
3. A return value (LSB) of 1 indicates that the overlapped command has finished. In case of a timeout, the operation is ongoing.
4. Reset timeout to former value
5. Clear the error queue with `SYStem:ERRor?` to remove the "-410, Query interrupted" entries.

Using several threads in the controller application

As an alternative, provided the programming environment of the controller application supports threads, separate threads can be used for the application GUI and for controlling the instrument(s) via SCPI.

A thread waiting for a *OPC? thus will not block the GUI or the communication with other instruments.

6.5 Status Reporting System

The status reporting system stores all information on the current operating state of the instrument, and on errors which have occurred. This information is stored in the status registers and in the error queue. Both can be queried with the commands `STATus . . .`

6.5.1 Hierarchy of status registers

As shown in the following figure, the status information is of hierarchical structure.

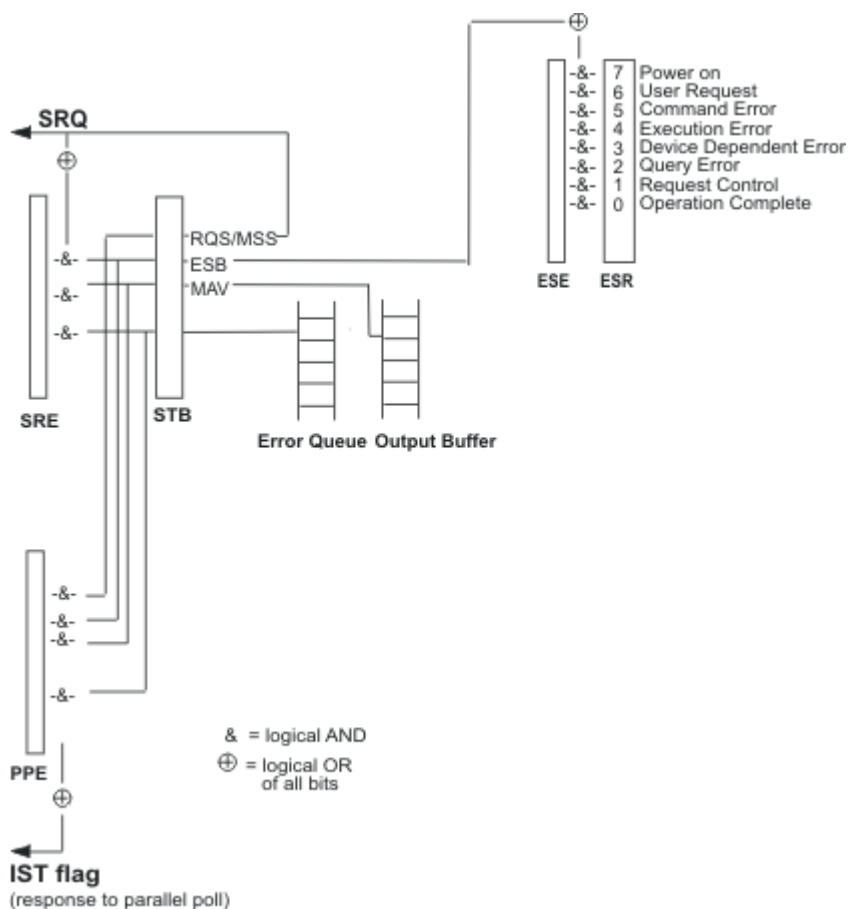

Fig. 6-1: Graphical overview of the status registers hierarchy

- **STB, SRE**

The STatus Byte (STB) register and its associated mask register Service Request Enable (SRE) form the highest level of the status reporting system. The STB provides a rough overview of the instrument status, collecting the information of the lower-level registers.

- **ESR, SCPI registers**

The STB receives its information from the following registers:

- The Event Status Register (ESR) with the associated mask register standard Event Status Enable (ESE).
- The STATUS:OPERation and STATUS:QUESTionable registers which are defined by SCPI and contain detailed information on the instrument.

- **IST, PPE**

The IST flag ("Individual STatus"), like the SRQ, combines the entire instrument status in a single bit. The PPE fulfills the same function for the IST flag as the SRE for the service request.

- **Output buffer**

The output buffer contains the messages the instrument returns to the controller. It is not part of the status reporting system but determines the value of the MAV bit in the STB and thus is represented in the overview.

All status registers have the same internal structure.



SRE, ESE

The service request enable register `SRE` can be used as `ENABLE` part of the `STB` if the `STB` is structured according to SCPI. By analogy, the `ESE` can be used as the `ENABLE` part of the `ESR`.

6.5.2 Structure of a SCPI Status Register

Each standard SCPI register consists of 5 parts. Each part has a width of 16 bits and has different functions. The individual bits are independent of each other, i.e. each hardware status is assigned a bit number which is valid for all five parts. Bit 15 (the most significant bit) is set to zero for all parts. Thus the contents of the register parts can be processed by the controller as positive integers.

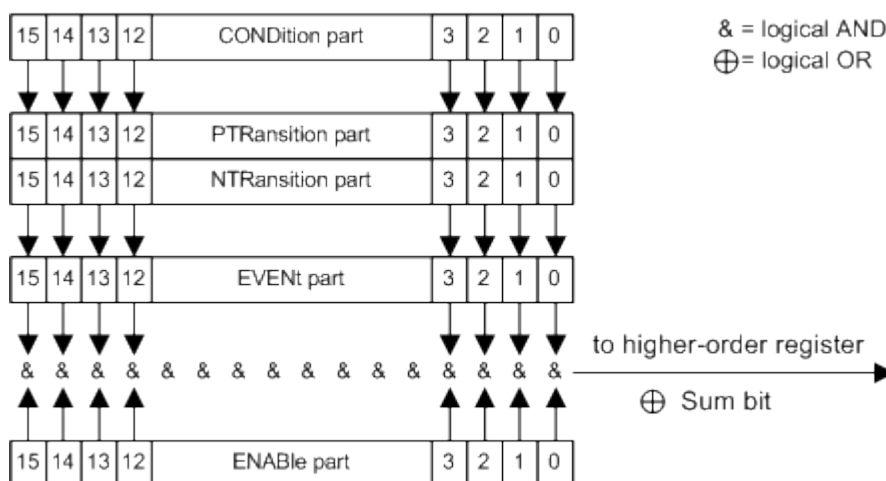

Fig. 6-2: The status-register model

Description of the five status register parts

The five parts of a SCPI register have different properties and functions:

- **CONDition**
The `CONDition` part is written into directly by the hardware or the sum bit of the next lower register. Its contents reflect the current instrument status. This register part can only be read, but not written into or cleared. Its contents are not affected by reading.
- **PTRansition**
The two transition register parts define which state transition of the `CONDition` part (none, 0 to 1, 1 to 0 or both) is stored in the `EVENT` part.
The `Positive-TRansition` part acts as a transition filter. When a bit of the `CONDition` part is changed from 0 to 1, the associated `PTR` bit decides whether the `EVENT` bit is set to 1.
 - `PTR` bit =1: the `EVENT` bit is set.
 - `PTR` bit =0: the `EVENT` bit is not set.

This part can be written into and read as required. Its contents are not affected by reading.

- **NTRansition**

The `NEGATIVE-TRANSITION` part also acts as a transition filter. When a bit of the `CONDITION` part is changed from 1 to 0, the associated `NTR` bit decides whether the `EVENT` bit is set to 1.

- `NTR` bit =1: the `EVENT` bit is set.
- `NTR` bit =0: the `EVENT` bit is not set.

This part can be written into and read as required. Its contents are not affected by reading.

- **EVENT**

The `EVENT` part indicates whether an event has occurred since the last reading, it is the "memory" of the condition part. It only indicates events passed on by the transition filters. It is permanently updated by the instrument. This part can only be read by the user. Reading the register clears it. This part is often equated with the entire register.

- **ENABLE**

The `ENABLE` part determines whether the associated `EVENT` bit contributes to the sum bit (see below). Each bit of the `EVENT` part is "ANDed" with the associated `ENABLE` bit (symbol '&'). The results of all logical operations of this part are passed on to the sum bit via an "OR" function (symbol '+').

`ENABLE` bit = 0: the associated `EVENT` bit does not contribute to the sum bit

`ENABLE` bit = 1: if the associated `EVENT` bit is "1", the sum bit is set to "1" as well.

This part can be written into and read by the user as required. Its contents are not affected by reading.

Sum bit

The sum bit is obtained from the `EVENT` and `ENABLE` part for each register. The result is then entered into a bit of the `CONDITION` part of the higher-order register.

The instrument automatically generates the sum bit for each register. Thus an event can lead to a service request throughout all levels of the hierarchy.

6.5.3 Contents of the Status Registers

In the following sections, the contents of the status registers are described in more detail.

6.5.3.1 Status Byte (STB) and Service Request Enable Register (SRE)

The `STATUS BYTE` (STB) is already defined in IEEE 488.2. It provides a rough overview of the instrument status by collecting the pieces of information of the lower registers. A special feature is that bit 6 acts as the sum bit of the remaining bits of the status byte.

The STB is read using the command `*STB` or a serial poll.

The `STATUS BYTE` (STB) is linked to the `SERVICE REQUEST ENABLE` (SRE) register. Each bit of the STB is assigned a bit in the SRE. Bit 6 of the SRE is ignored. If a bit is set in the SRE and the associated bit in the STB changes from 0 to 1, a service request

(SRQ) is generated. The SRE can be set using the command `*SRE` and read using the command `*SRE?`.

Table 6-3: Meaning of the bits used in the status byte

Bit No.	Meaning
0...1	Not used
2	Error Queue not empty The bit is set when an entry is made in the error queue. If this bit is enabled by the SRE, each entry of the error queue generates a service request. Thus an error can be recognized and specified in greater detail by polling the error queue. The poll provides an informative error message. This procedure is to be recommended since it considerably reduces the problems involved with remote control.
3	Not used.
4	MAV bit (message available) The bit is set if a message is available in the output buffer which can be read. This bit can be used to enable data to be automatically read from the instrument to the controller.
5	ESB bit Sum bit of the event status register. It is set if one of the bits in the event status register is set and enabled in the event status enable register. Setting of this bit indicates a serious error which can be specified in greater detail by polling the event status register.
6	MSS bit (master status summary bit) The bit is set if the instrument triggers a service request. This is the case if one of the other bits of this registers is set together with its mask bit in the service request enable register SRE.
7	Not used.

6.5.3.2 IST Flag and Parallel Poll Enable Register (PPE)

As with the SRQ, the IST flag combines the entire status information in a single bit. It can be read by means of a parallel poll (see [chapter 6.5.5.3, "Parallel Poll"](#), on page 301) or using the command `*IST`.

The parallel poll enable register (PPE) determines which bits of the STB contribute to the IST flag. The bits of the STB are "ANDed" with the corresponding bits of the PPE, with bit 6 being used as well in contrast to the SRE. The IST flag results from the "ORing" of all results. The PPE can be set using commands `*PRE` and read using command `*PRE?`.

6.5.4 Event Status Register (ESR) and Event Status Enable Register (ESE)

The ESR is defined in IEEE 488.2. The event status register can be read out using command `*ESR` on page 306. The ESE is the associated enable part. It can be set using the command `*ESE` on page 306 and read using the command `*ESE?`.

Table 6-4: Meaning of the bits used in the event status register

Bit No.	Meaning
0	Operation Complete This bit is set on receipt of the command *OPC exactly when all previous commands have been executed.
1	not used
2	Query Error This bit is set if either the controller wants to read data from the instrument without having sent a query, or if it does not fetch requested data and sends new instructions to the instrument instead. The cause is often a query which is faulty and hence cannot be executed.
3	Device-dependent Error This bit is set if a device dependent error occurs. An error message with a number between 300 and 399 or a positive error number, which denotes the error in greater detail, is entered into the error queue.
4	Execution Error This bit is set if a received command is syntactically correct but cannot be performed for other reasons. An error message with a number between 200 and 300, which denotes the error in greater detail, is entered into the error queue.
5	Command Error This bit is set if a command which is undefined or syntactically incorrect is received. An error message with a number between 100 and 200, which denotes the error in greater detail, is entered into the error queue.
6	User Request This bit is set on pressing the LOCAL key, i.e. when the instrument is switched over to manual operation.
7	Power On (supply voltage on) This bit is set on switching on the instrument.

6.5.5 Application of the Status Reporting System

The purpose of the status reporting system is to monitor the status of one or several devices in a measuring system. To do this and react appropriately, the controller must receive and evaluate the information of all devices. The following standard methods are used:

- **Service request (SRQ)** initiated by the instrument
- **Serial poll** of all devices in the bus system, initiated by the controller in order to find out who sent a SRQ and why
- **Parallel poll** of all devices
- Query of a **specific instrument status** by means of commands
- Query of the **error queue**

6.5.5.1 Service Request

Under certain circumstances, the instrument can send a service request (SRQ) to the controller. Usually this service request initiates an interrupt at the controller, to which the control program can react appropriately. An SRQ is always initiated if one or several of bits 2, 4 or 5 of the status byte are set and enabled in the SRE. Each of these bits combines the information of the error queue or the output buffer. In order to use the possibilities of the service request effectively, all bits should be set to "1" in the enable registers SRE and ESE.

Example:

Use command `*OPC` to generate an SRQ .

`*ESE 1` - set bit 0 of ESE (Operation Complete)

`*SRE 32` - set bit 5 of SRE (ESB).

After its settings have been completed, the instrument generates an SRQ.

The SRQ is the only possibility for the instrument to become active on its own. Each controller program should set the instrument such that a service request is initiated in the case of malfunction. The program should react appropriately to the service request.

6.5.5.2 Serial Poll

In a serial poll, just as with command `*STB`, the status byte of an instrument is queried. However, the query is realized via interface messages and is thus clearly faster.

The serial poll method is defined in IEEE 488.1 and used to be the only standard possibility for different instruments to poll the status byte. The method also works for instruments which do not adhere to SCPI or IEEE 488.2.

The serial poll is mainly used to obtain a fast overview of the state of several instruments connected to the controller.

6.5.5.3 Parallel Poll

In a parallel poll, up to eight instruments are simultaneously requested by the controller using a single command to transmit 1 bit of information each on the data lines, i.e., to set the data line allocated to each instrument to a logical "0" or "1".

In addition to the SRE register, which determines the conditions under which an SRQ is generated, there is a Parallel Poll Enable register (PPE) which is ANDed with the STB bit by bit, considering bit 6 as well. This register is ANDed with the STB bit by bit, considering bit 6 as well. The results are ORed, the result is possibly inverted and then sent as a response to the parallel poll of the controller. The result can also be queried without parallel poll using the command `*IST`.

The instrument first has to be set for the parallel poll using the command `PPC`. This command allocates a data line to the instrument and determines whether the response is to be inverted. The parallel poll itself is executed using `PPE`.

The parallel poll method is mainly used to find out quickly which one of the instruments connected to the controller has sent a service request. To this effect, SRE and PPE must be set to the same value.

6.5.5.4 Query of an instrument status

Each part of any status register can be read using queries. There are two types of commands:

- The common commands `*ESR?`, `*IDN?`, `*IST?`, `*STB?` query the higher-level registers.
- The commands of the `STATus` system query the SCPI registers (`STATus:QUEStionable...`)

The returned value is always a decimal number that represents the bit pattern of the queried register. This number is evaluated by the controller program.

Queries are usually used after an SRQ in order to obtain more detailed information on the cause of the SRQ.

6.5.5.5 Error Queue

Each error state in the instrument leads to an entry in the error queue. The entries of the error queue are detailed plain text error messages that can be looked up in the Error Log or queried via remote control using `SYSTEM:ERROR[:NEXT]?` or `SYSTEM:ERROR:ALL?`. Each call of `SYSTEM:ERROR[:NEXT]?` provides one entry from the error queue. If no error messages are stored there any more, the instrument responds with 0, "No error".

The error queue should be queried after every SRQ in the controller program as the entries describe the cause of an error more precisely than the status registers. Especially in the test phase of a controller program the error queue should be queried regularly since faulty commands from the controller to the instrument are recorded there as well.

6.5.6 Reset Values of the Status Reporting System

The following table contains the different commands and events causing the status reporting system to be reset. None of the commands, except `*RST` and `SYSTEM:PRESet`, influence the functional instrument settings. In particular, `DCL` does not change the instrument settings.

Table 6-5: Resetting the status reporting system

Event	Switching on supply voltage Power-On-Status-Clear		DCL, SDC (Device Clear, Selected Device Clear)	*RST or SYS-Tem:PRE-Set	STA-Tus:PRE-Set	*CLS
	0	1				
Clear STB, ESR	-	yes	-	-	-	yes
Clear SRE, ESE	-	yes	-	-	-	-
Clear PPE	-	yes	-	-	-	-
Clear error queue	yes	yes	-	-	-	yes
Clear output buffer	yes	yes	yes	1)	1)	1)
Clear command processing and input buffer	yes	yes	yes	-	-	-

1) The first command in a command line that immediately follows a <PROGRAM MESSAGE TERMINATOR> clears the output buffer.

6.6 General Programming Recommendations

Initial instrument status before changing settings

Manual operation is designed for maximum possible operating convenience. In contrast, the priority of remote control is the "predictability" of the instrument status. Thus, when a command attempts to define incompatible settings, the command is ignored and the instrument status remains unchanged, i.e. other settings are not automatically adapted. Therefore, control programs should always define an initial instrument status (e.g. using the *RST command) and then implement the required settings.

Command sequence

As a general rule, send commands and queries in different program messages. Otherwise, the result of the query may vary depending on which operation is performed first (see also Preventing Overlapping Execution).

Reacting to malfunctions

The service request is the only possibility for the instrument to become active on its own. Each controller program should instruct the instrument to initiate a service request in case of malfunction. The program should react appropriately to the service request.

Error queues

The error queue should be queried after every service request in the controller program as the entries describe the cause of an error more precisely than the status registers. Especially in the test phase of a controller program the error queue should be queried

regularly since faulty commands from the controller to the instrument are recorded there as well.

7 Remote Control Commands

In the following, all remote-control commands will be presented in detail with their parameters and the ranges of numerical values.

For an introduction to remote control and the status registers, refer to [chapter 6, "Remote Control Basics"](#), on page 265.

7.1 Common Commands

Common commands are described in the IEEE 488.2 (IEC 625-2) standard. These commands have the same effect and are employed in the same way on different devices. The headers of these commands consist of "*" followed by three letters. Many common commands are related to the Status Reporting System.

Available common commands:

*CAL.....	305
*CLS.....	305
*ESE.....	306
*ESR.....	306
*IDN.....	306
*IST.....	306
*OPC.....	307
*OPT.....	307
*PCB.....	307
*PRE.....	307
*PSC.....	307
*RCL.....	308
*RST.....	308
*SAV.....	308
*SRE.....	308
*STB.....	309
*TRG.....	309
*TST.....	309
*WAI.....	309

*CAL

Calibration Query

Initiates a calibration of the instrument and subsequently queries the calibration status. Responses > 0 indicate errors.

*CLS

CLear Status

Sets the status byte (STB), the standard event register (ESR) and the `EVENT` part of the `QUESTIONABLE` and the `OPERATION` registers to zero. The command does not alter the mask and transition parts of the registers. It clears the output buffer.

Usage: Setting only

*ESE <Value>

Event Status Enable

Sets the event status enable register to the specified value. The query returns the contents of the event status enable register in decimal form.

Parameters:

<Value> Range: 0 to 255

*ESR?

Event Status Read

Returns the contents of the event status register in decimal form and subsequently sets the register to zero.

Return values:

<Contents> Range: 0 to 255

Usage: Query only

*IDN?

IDeNtification: returns the instrument identification.

Return values:

<ID> "Rohde&Schwarz,<device type>,<serial number>,<firmware version>"

Example: Rohde&Schwarz,ZVA8-4Port,12345,0.10.1.23

Usage: Query only

*IST?

Individual SStatus query

Returns the contents of the IST flag in decimal form. The IST flag is the status bit which is sent during a parallel poll.

Return values:

<ISTflag> 0 | 1

Usage: Query only

***OPC**

Operation Complete

Sets bit 0 in the event status register when all preceding commands have been executed. This bit can be used to initiate a service request. The query form writes a "1" into the output buffer as soon as all preceding commands have been executed. This is used for command synchronization.

***OPT?**

OPTion identification query

Queries the options included in the instrument. For a list of all available options and their description refer to the CD-ROM.

Return values:

<Options> The query returns a list of options. The options are returned at fixed positions in a comma-separated string. A zero is returned for options that are not installed.

Usage: Query only

***PCB <Address>**

Pass Control Back

Indicates the controller address to which remote control is returned after termination of the triggered action.

Setting parameters:

<Address> Range: 0 to 30

Usage: Setting only

***PRE <Value>**

Parallel poll Register Enable

Sets parallel poll enable register to the indicated value. The query returns the contents of the parallel poll enable register in decimal form.

Parameters:

<Value> Range: 0 to 255

***PSC <Action>**

Power on Status Clear

Determines whether the contents of the `ENABLE` registers are preserved or reset when the instrument is switched on. Thus a service request can be triggered when the instrument is switched on, if the status registers ESE and SRE are suitably configured. The query reads out the contents of the "power-on-status-clear" flag.

Parameters:

<Action>	0 1
0	The contents of the status registers are preserved.
1	Resets the status registers.

***RCL** <Number>

ReCaLI calls up the instrument settings from an intermediate memory identified by the specified number. The instrument settings can be stored to this memory using the command ***SAV** with the associated number.

It also activates the instrument settings which are stored in a file and loaded using the `MMEMory:LOAD <number>, <file_name.extension>` command.

***RST**

ReSeT

Sets the instrument to a defined default status. The default settings are indicated in the description of commands.

The command is equivalent to `SYSTem:PRESet`.

Usage: Setting only

***SAV** <Number>

SAVe stores the current instrument settings under the specified number in an intermediate memory. The settings can be recalled using the command ***RCL** with the associated number.

To transfer the stored instrument settings in a file, use the command `:MMEMory:STORe:STATe`.

***SRE** <Contents>

Service Request Enable

Sets the service request enable register to the indicated value. This command determines under which conditions a service request is triggered.

Parameters:

<Contents>	Contents of the service request enable register in decimal form. Bit 6 (MSS mask bit) is always 0. Range: 0 to 255
------------	--

***STB?**

STatus Byte query

Reads the contents of the status byte in decimal form.

Usage: Query only

***TRG**

TRiGger

Triggers all actions waiting for a trigger event. In particular, *TRG generates a manual trigger signal (Manual Trigger). This common command complements the commands of the TRIGger subsystem.

Usage: Event

***TST?**

self TeST query

Triggers selftests of the instrument and returns an error code in decimal form (see Service Manual supplied with the instrument). "0" indicates no errors occurred.

Usage: Query only

***WAI**

WAIt to continue

Prevents servicing of the subsequent commands until all preceding commands have been executed and all signals have settled (see also command synchronization and *OPC).

Usage: Event

7.2 Preset Commands

The preset commands are not bundled in one subsystem. Therefore, they are listed separately in this section. In addition, a specific preset command is provided for each digital standard and for the fader. These specific commands are described in the associated subsystems.

Four presetting actions are available:

- Activating the default state of all internal instrument functions (*RST on page 308). Functions that concern the integration of the instrument into a measurement setup are not changed, e.g. GPIB address or reference oscillator source settings.
- Activating the preset state of the parameters related to the selected signal path (: SOURce<hw> : PRESet on page 310)

- Activating the preset state of all parameters that are not related to the signal path ([:DEVIce:PRESet](#) on page 310)
- Activating the original state of delivery (factory reset, [:SYSTem:FPreSet](#) on page 310). Only functions that are protected by a password remain unchanged as well as the passwords themselves.

:DEVIce:PRESet

The command presets all parameters which are not related to the signal path. This includes presetting the LF generator and bit/block error measurement.

Example: `DEV:PRESet`
presets all instruments settings that are not related to the signal path

Usage: Event

:SOURce<hw>:PRESet

The command presets all parameters which are related to the selected signal path.

Fading (if available) and transient recorder are only preset by command `*RST`.

Example: `SOUR:PRESet`
presets all settings that are related to signal path

SYSTem:PRESet

The command triggers an instrument reset. It has the same effect as:

- the PRESET key on the front panel
- the `*RST` command

For an overview of the settings affected by the preset function, see [chapter 5.2.2, "Default Instrument Settings - Preset Key"](#), on page 89.

Example: `SYST:PRESet`
All instrument settings (also those that are not currently active) are reset to their default values.

Usage: Setting only

:SYSTem:FPreSet

The command triggers an instrument reset to the original state of delivery.

Note: Since Factory Preset resets the Remote Channel and network settings to the default values, executing Factory Preset via remote control terminates the connection to the instrument, if these settings had been configured to values different to the default ones!

The factory preset function resets nearly all instrument settings. In addition to the regular preset by means of the PRESET key, a "Factory Preset" resets also the following values:

- Reference frequency settings ("Ref Oscillator" menu)
- Power on settings ("Level/EMF" menu)
- Network settings including hostname ("Setup" menu)
- Remote Channel settings including GPIB address ("Setup" menu)
- Start/Stop Gui Update ("Setup" menu)
- Display and keyboard settings ("Setup" menu).

To maintain security, password settings and all settings protected by these passwords like disabled USB and LAN connections are not changed.

Not affected by the "Factory Preset" are also user data, lists or instrument settings files, created for example by means of the Save/Recall function.

Example: `SYST:FPR`
all instrument settings (also those that are not currently active) are reset to the factory values.

Usage: Event

7.3 CALibration Subsystem

The CALibration system contains the commands for adjustment. Adjustment is triggered by the query commands. The response "0" indicates error-free adjustment, and the response "1" means that an error occurred during adjustment.

<code>:CALibration:ALL[:MEASure]</code>	311
<code>:CALibration<hw>:FREQuency[:MEASure]</code>	312
<code>:CALibration<hw>:LEVel:LOOPgain:STATe</code>	312
<code>:CALibration<hw>:LEVel[:MEASure]</code>	312
<code>:CALibration<hw>:LEVel:EXTern:DATA</code>	312
<code>:CALibration<hw>:LEVel:STATe</code>	313
<code>:CALibration:LFOutput[:MEASure]</code>	313

`:CALibration:ALL[:MEASure]?`

The command starts all internal adjustments for which no external measuring equipment is needed.

Return values:

<Measure> 0 | 1

Example: `CAL:ALL:MEAS?`
starts the adjustment of all functions for the entire instrument.
Response: "0"
adjustment has been performed successfully.

Usage: Query only
SCPI confirmed

:CALibration<hw>:FREQuency[:MEASure]?

The command starts all adjustments which affect the frequency.

Return values:

<Measure> 0 | 1

Example:

CAL:FREQ:MEAS?

starts the adjustments for maximum frequency accuracy.

Response: "0"

the adjustments have been performed successfully.

Usage:

Query only

:CALibration<hw>:LEVel:LOOPgain:STATe <State>

The command switches on or off use of external loopgain correction data.

Parameters:

<State> 0 | 1 | OFF | ON

Example:

CAL:LEV:LOOP:STAT ON

switches on use of external loopgain correction data.

:CALibration<hw>:LEVel[:MEASure]?

The command starts all adjustments which affect the level.

Return values:

<Measure> 0 | 1

Example:

CAL:LEV:MEAS?

starts adjustments for maximum level accuracy.

Response: "0"

adjustment has been performed successfully.

Usage:

Query only

:CALibration<hw>:LEVel:EXTern:DATA <Data>

Selects the data used for of external level correction.

By default the instrument uses correction data obtained in the factory before delivery. In addition, customer data can be used for external level correction. The customer data is obtained using a R&S NRP power sensor. External level correction is a protected function (see service manual, chapter 2, "Adjustment").

Parameters:

<Data> FACT | CUST
*RST: FACTory

Example:

CAL:LEV:EXT:DATA FACT

selects the use of the data aquired at the factory for external level correction.

:CALibration<hw>:LEVel:STATe <State>

The command switches on or off internal level correction.

Parameters:

<State> ON | OFF
*RST: ON

Example:

CAL:LEV:STAT
switches on Level correction.

:CALibration:LFOOutput[:MEASure] <Measure>

Performs all adjustments which affect the internal modulation generator.

Parameters:

<Measure>

Example:

CAL:LFO?
starts the adjustments for the modulation generators.
Response: 0
the adjustments have been performed successfully.

Options:

R&S SMF-B20

7.4 DIAGnostic Subsystem

The `DIAGnostic` system contains the commands used for instrument diagnosis and servicing. SCPI does not define any `DIAGnostic` commands; the commands listed here are all Device-specific. All `DIAGnostic` commands are query commands which are not influenced by `*RST`.

:DIAGnostic<hw>:BGInfo	313
:DIAGnostic<hw>:BGInfo:CATalog	314
:DIAGnostic:INFO:OTIME	314
:DIAGnostic:INFO:POCount	314

:DIAGnostic<hw>:BGInfo?

The command checks the modules available in the instrument using the variant and revision state.

If the command is sent without parameters being specified, a complete list of all modules is returned (the various entries are separated by commas). The length of the list is variable and depends on the instrument equipment configuration.

If the command is sent with parameters, a list of the specified modules is returned (the various entries are separated by commas). A list of modules names can be called up using the command `:DIAGnostic<hw>:BGInfo:CATalog` on page 314.

Return values:

<Bginfo> < Module name> <Module stock number incl. variant> <Module revision> <Module serial number>

Each entry for one module consists of four parts which are separated by space characters.

Example:

DIAG:BGIN:CAT?

queries the instrument configuration.

Response: FSYN,MWIF,

returns the data of all available modules.

DIAG:BGIN? 'FSYN'

queries the configuration of the FSYN.

Response: FSYN 1234.5678.02 1.5.3 100023

module FSYB with stock number 1234.5678.02 has revision 1.5.3 and serial number 100023.

Usage:

Query only

:DIAGnostic<hw>:BGInfo:CATalog?

The command queries the names of the assemblies available in the instrument.

A complete list of all assemblies is returned (the various entries are separated by commas). The length of the list is variable and depends on the instrument equipment configuration.

Return values:

<Catalog> string

Example:

DIAG:BGIN:CAT

queries the names of the assemblies.

Response: MBRD,SSYN,

Usage:

Query only

:DIAGnostic:INFO:OTIMe?

The command queries the number of operation hours.

Return values:

<OTIMe> float

Example:

DIAG:INFO:OTIM

queries the operation hours.

Response: 100023

The instrument was operated for 100023 hours up to now.

Usage:

Query only

:DIAGnostic:INFO:POCount?

The command queries the number of power-on events.

Return values:`<Pocount>` float**Example:**

DIAG:INFO:POC

queries the number of power on events.

Response: 123

The instrument was switched on for 123 times up to now.

Usage:

Query only

7.5 DISPlay Subsystem

The DISPlay system contains the commands to set the power-save mode of the instrument.

:DISPlay:PSAVe:HOLDoff `<Holdoff>`

This command sets the wait time for the screen-save mode of the display. The available value range is 1 to 60 minutes, the resolution 1 minute. The entry is dimensionless.

Parameters:

`<Holdoff>` float
 Range: 1 to 60
 *RST: 1
 Default unit: minute

Example:

DISP:PSAV:HOLD 10

sets the wait for the screen saver mode to 10 minutes.

:DISPlay:PSAVe[:STATe] `<State>`

This command activates/deactivates the screen-save mode of the display. With the screen-save mode activated the display including backlight is completely switched off after the elapse of the wait time (see command `DISPlay:PSAVe:HOLDoff`) when no entries via front panel, external mouse or external keyboard are made.

This mode is recommended for preserving the display especially if the instrument is exclusively operated via remote control.

Parameters:

`<State>` 0 | 1 | OFF | ON
 *RST: OFF

Example:

DISP:PSAV ON

activates screen saver mode.

7.6 FORMat Subsystem

The FORMat subsystem contains the commands which determine the format of the data that the R&S SMF returns to the controller. This affects all query commands which return a list of numerical data or block data. Reference is made to this in the descriptions of the commands.

:FORMat:BORDER.....	316
:FORMat[:DATA].....	316
:FORMat:SREGister.....	317

:FORMat:BORDER <Border>

The command determines the sequence of bytes within a binary block. This only affects blocks which use the IEEE754 format internally.

Parameters:

<Border> NORMAL | SWAPped

NORMAL

The instrument expects (with setting commands) and sends (with queries) the least significant byte of each IEEE754 floating-point number first and the most significant byte last.

SWAPped

The instrument expects (with setting commands) and sends (with queries) the most significant byte of each IEEE754 floating-point number first and the least significant byte last.

*RST: NORMAL

Example:

FORM:BORDER SWAP

the data is transferred with the most significant bit first.

:FORMat[:DATA] <Data>

The command determines the data format which the R&S Signal Generator uses to return data. When data is transferred from the control computer to the instrument, the instrument detects the data format automatically. In this case, the value set here is irrelevant.

Parameters:

<Data> ASCII | PACKed

ASCII

Numerical data is transferred as plain text separated by commas.

PACKed

Numerical data is transferred as binary block data. The format within the binary data depends on the command. The various binary data formats are explained in the description of the parameter types.

*RST: ASCII

Example:

FORM ASC

The data is transferred as ASCII data.

:FORMat:SREGister <Sregister>

The command determines the numerical format which is returned when the status registers are queried.

Parameters:

<Sregister>

ASCIi | BINary | HEXadecimal | OCTal

ASCIi

The register content is returned as a decimal number.

BINary

The register content is returned as a binary number. #B is placed in front of the number.

HEXadecimal

The register content is returned as a hexadecimal number. #H is placed in front of the number.

OCTal

The register content is returned as an octal number. #Q is placed in front of the number.

*RST: ASCIi

Example:

FORM:SREG HEX

The register content is returned as a hexadecimal number.

7.7 HCOpy Subsystem

The HCOpy subsystem contains the commands to generate a hardcopy of the display.

:HCOpy:DATA.....	318
:HCOpy:DEvice.....	318
:HCOpy:DEvice:LANGUage.....	318
:HCOpy[:EXECute].....	318
:HCOpy:FILE[:NAME].....	319
:HCOpy:FILE[:NAME]:AUTO.....	319
:HCOpy:FILE[:NAME]:AUTO:DIRectory.....	319
:HCOpy:FILE[:NAME]:AUTO:DIRectory:CLEar.....	320
:HCOpy:FILE[:NAME]:AUTO:FILE.....	320
:HCOpy:FILE[:NAME]:AUTO[:FILE]:DAY.....	320
:HCOpy:FILE[:NAME]:AUTO[:FILE]:DAY:STATe.....	321
:HCOpy:FILE[:NAME]:AUTO[:FILE]:MONTH.....	321
:HCOpy:FILE[:NAME]:AUTO[:FILE]:MONTH:STATe.....	321
:HCOpy:FILE[:NAME]:AUTO[:FILE]:NUMBer.....	321
:HCOpy:FILE[:NAME]:AUTO[:FILE]:PREFix.....	322
:HCOpy:FILE[:NAME]:AUTO[:FILE]:PREFix:STATe.....	322
:HCOpy:FILE[:NAME]:AUTO[:FILE]:YEAR.....	322
:HCOpy:FILE[:NAME]:AUTO[:FILE]:YEAR:STATe.....	323
:HCOpy:FILE[:NAME]:AUTO:STATe.....	323
:HCOpy:IMAGe:FORMat.....	323
:HCOpy:IMAGe:SIZE.....	323

:HCOPY:DATA?

The command transfers the hardcopy data directly as a NByte stream to the remote client.

Return values:

<Data> string

Example:

HCOP:DEV:LANG JPG

HCOP:DATA?

transfers the hardcopy to the remote client.

Usage:

Query only

:HCOPY:DEvice <Device>

The command defines the output device. The hardcopy can be output in a file. The `HCOPY:FILE:...` commands are used for configuration. The file is accessible using the `MMEM:..` commands. In addition, the hardcopy data can be directly transferred to the remote client using command `:HCOPY:DATA`.

Parameters:

<Device> FILE
*RST: FILE

Example:

HCOP:DEV FILE

the hardcopy will be stored in a file.

:HCOPY:DEvice:LANGuage <Language>

The command selects the bitmap graphic format for the screenshot. It is also possible to directly retrieve the data using command `HCOP:DATA?`. This command is an alias to command `HCOPY:IMAGE:FORMat`.

Parameters:

<Language> BMP | JPG | XPM | PNG
*RST: BMP

Example:

HCOP:DEV:LANG BMP

selects bitmap as image format.

HCOP:FILE '/usb/HCopy'

defines the directory, path and file name for storing the hardcopy.

HCOP

triggers the hardcopy generation.

:HCOPY[:EXECute]

The command triggers the generation of a hardcopy.

Example:

HCOP

triggers the generation of a hardcopy of the current display.

Usage: Event

:HCOpy:FILE[:NAME] <Name>

This command creates/selects a file into which the hardcopy will be stored. The path is specified together with the file name. Access to the file via remote control is possible using the commands of the MMEM-Subsystem. In contrast, command `HCOpy:DATA?` transfers the hardcopy contents directly to the remote client where they can be further processed.

If automatic file naming is activated, the hardcopy is stored into a file with an automatically generated name (commands `HCOpy:FILE[:NAME]:AUTO:...`).

Parameters:

<Name> string

Example: `HCOpy:FILE:NAME '/usb/HCopy'`
defines the hardcopy file name.

:HCOpy:FILE[:NAME]:AUTO?

This command queries the path including the file name of the file with automatically generated name.

Return values:

<Auto> string

Example: `HCOpy:DEV:LANG BMP`
selects output format `*,bmp`.
`HCOpy:FILE:AUTO:DIR '/usb/HCopy'`
defines the destination directory `'/usb/HCopy'`.
`HCOpy:FILE:AUTO:PREFIX 'gen'`
the file name starts with the prefix `'gen'`. The usage of automatic naming with prefix and date in the file name is preset (`...:STAT ON`).
`HCOpy`
triggers the generation of a hardcopy of the current trace.
`HCOpy:FILE:AUTO?`
queries the path including the file name
Response:
`/usb/HCopy/gen101012008001.bmp'`

Usage: Query only

:HCOpy:FILE[:NAME]:AUTO:DIRectory <Directory>

This command defines the directory into which the hardcopy files will be stored if auto naming is activated (`HCOpy:FILE:AUTO:STAT ON`). The directory will be created if it does not exist yet.

Parameters:

<Directory> string
 *RST: .\HCopy

Example:

HCOP:FILE:AUTO:DIR '/usb/HCopy'
 defines the destination directory '/usb/HCopy'

:HCOPY:FILE[:NAME]:AUTO:DIRectory:CLEar

This command deletes all files with extensions "bmp", "img", "png" and "xpm" in the directory set for automatic naming.

Example:

HCOP:FILE:AUTO:DIR:CLE
 deletes all image files with extensions "bmp", "img", "png" and "xpm".

Usage:

Event

:HCOPY:FILE[:NAME]:AUTO:FILE?

This command queries the file name that was generated using the automatic naming settings. By default the automatically generated file name is composed of:

<Prefix><YYYY><MM><DD><Number>.<Format>.

Each component can be deactivated/activated separately to individually design the file name.

Return values:

<File> string

Example:

HCOP:DEV:LANG BMP
 selects output format *.bmp.
 HCOP:FILE:AUTO:DIR '/usb/HCopy'
 defines the destination directory '/usb/HCopy'
 HCOP:FILE:AUTO:PREF 'gen'
 the file name starts with the prefix 'gen'. The usage of automatic naming with prefix and date in the file name is preset (...:STAT ON).
 HCOP
 triggers the generation of a hardcopy of the current trace.
 HCOP:FILE:AUTO:FILE?
 queries the file name
 Response: 'gen101012008001.bmp'

Usage:

Query only

:HCOPY:FILE[:NAME]:AUTO[:FILE]:DAY?

The command returns the day of the current system date which will be used in the file name if automatic naming is activated.

Return values:

<Day> float

Example:

HCOP:FILE:AUTO:DAY?

returns the day in the date part of the automatic file name.

Usage:

Query only

:HCOPY:FILE[:NAME]:AUTO[:FILE]:DAY:STATe <State>

This command activates the usage of the day in the automatic file name.

Parameters:

<State> 0 | 1 | OFF | ON

*RST: ON

Example:

HCOP:FILE:AUTO:DAY:STAT OFF

deactivates the use of the day in the automatically generated file name.

:HCOPY:FILE[:NAME]:AUTO[:FILE]:MONTH?

This command queries the month in the date part in the automatic file name.

Return values:

<Month> float

Example:

HCOP:FILE:AUTO:MONT?

queries the month in the date part in the automatic file name.

Usage:

Query only

:HCOPY:FILE[:NAME]:AUTO[:FILE]:MONTH:STATe <State>

This command activates the usage of the month in the automatic file name.

Parameters:

<State> 0 | 1 | OFF | ON

*RST: ON

Example:

HCOP:FILE:AUTO:MONT:STAT OFF

deactivates the usage of the month in the automatic file name.

:HCOPY:FILE[:NAME]:AUTO[:FILE]:NUMBer?

This command queries the number in the automatic file name. The number is assigned in such a way that always the lowest possible value for an unique file name within the selected path is used.

On initially switching on the device the number will be reset to the lowest possible value. Starting with number 0 the output directory will be scanned for already existing files. As long as files with the same name are existing the number will be incremented by 1. The number will be automatically set to a number so that the resulting file name will be unique within the selected path. The current number will not be saved in the save recall file but will be temporarily stored within the database. On subsequent saves the number will be incremented.

Return values:

<Number> float

Example:

HCOPY:FILE:AUTO:NUMB?
queries the number in the automatic file name.

Usage:

Query only

:HCOPY:FILE[:NAME]:AUTO[:FILE]:PREFIX <Prefix>

This command defines the prefix part in the automatic file name. The usage of the prefix is activated with command HCOPY:FILE:AUTO:PREFIX:STAT ON.

Parameters:

<Prefix> string
*RST: HCopy

Example:

HCOPY:FILE:AUTO:PREFIX 'Snapshot'
appends "Snapshot" as prefix to the generated file name.

:HCOPY:FILE[:NAME]:AUTO[:FILE]:PREFIX:STATE <State>

This command activates the usage of the prefix in the automatic file name. The prefix is entered with command HCOPY:FILE:AUTO:PREFIX.

Parameters:

<State> 0 | 1 | OFF | ON
*RST: ON

Example:

HCOPY:FILE:AUTO:PREFIX:STAT OFF
deactivates the usage of the prefix in the automatic file name.

:HCOPY:FILE[:NAME]:AUTO[:FILE]:YEAR?

This command queries the year in the date part in the automatic file name.

Return values:

<Year> float

Example:

HCOPY:FILE:AUTO:YEAR?
queries the year in the date part in the automatic file name.

Usage:

Query only

:HCOPY:FILE[:NAME]:AUTO[:FILE]:YEAR:STATe <State>

This command activates the usage of the year in the automatic file name.

Parameters:

<State> 0 | 1 | OFF | ON
*RST: ON

Example:

HCOP:FILE:AUTO:YEAR:STAT OFF
deactivates the usage of the year in the automatic file name.

:HCOPY:FILE[:NAME]:AUTO:STATe <State>

This command activates/deactivates automatic naming of the hardcopy files.

Parameters:

<State> 0 | 1 | OFF | ON
*RST: ON

Example:

HCOP:FILE:AUTO:STAT OFF
deactivates automatic naming.

:HCOPY:IMAGe:FORMat <Format>

This command selects the bitmap graphic format for the screenshot. It is also possible to directly retrieve the data using command `HCOP:DATA?`.

This command is an alias to command `HCOPY:DEVIce:LANGUage`.

Parameters:

<Format> BMP | JPG | XPM | PNG
*RST: BMP

Example:

HCOP:IMAG:FORM XPM
selects the image format XPM.

:HCOPY:IMAGe:SIZE <Size>

The command selects the image size of the hardcopy. The first value of the size setting defines the width, the second value the height of the image.

Parameters:

<Size> 320,640 | 640,480 | 800,600 | 1024,768
*RST: depends on device

Example:

HCOP:IMAG:SIZE 640,480
sets width and height of the image.

7.8 KBOard Subsystem

The KBOard system contains the commands to set the external keyboard.

:KBOard:LANGuage.....	324
:KBOard:LAYout.....	324

:KBOard:LANGuage <Language>

This command selects the keyboard language. The assignment of some keys depends on the selected language.

Parameters:

<Language> US | DE
 *RST: US

Example:

KBO:LANG US
 selects keyboard language American English.

Usage:

SCPI confirmed

:KBOard:LAYout?

This command selects the keyboard language. The assignment of some keys depends on the selected language.

Return values:

<Layout> CHINese | DANish | DUTCh | ENGUK | ENGUS | FINNish |
 FRENch | FREBe | FRECa | GERMan | ITALian | JAPANese |
 KORean | NORWegian | PORTuguese | RUSSian | SPANish |
 SWEDish
 *RST: US

Example:

KBO:LAY US
 activates American keyboard layout.

Usage:

Query only
 SCPI confirmed

7.9 MMEMory Subsystem

The MMEMory subsystem (**Mass Memory**) contains the commands for managing files and directories as well as for loading and storing complete instrument settings in files.

The files are stored on the CompactFlash™ Card of the instrument or on external USB memory devices.

The /var directory can be used to save user-defined data; any subdirectory structure can be created on /var. Some default subdirectories are predefined, but can be changed at any time.

The default directory is determined using the command `MMEMory:CDIR`.



The `/opt` directory is a protected and therefore inaccessible system directory. The files on this directory contain data that must not be changed. Therefore, this directory should not be accessed, since reconstruction of the system partition will lead to data loss.

7.9.1 File Naming Conventions

To enable files in different file systems to be used, the following file naming conventions should be observed.

The file name can be of any length and no distinction is made between uppercase and lowercase letters. The file and the optional file extension are separated by a dot. All letters and numbers are permitted (numbers are, however, not permitted at the beginning of the file name). Where possible, special characters should not be used. Use of the slashes "\" and "/" should be avoided since they are used in file paths. A number of names are reserved by the operating system, e.g. `CLOCK$`, `CON`, `AUX`, `COM1` . . . `COM4`, `LPT1` . . . `LPT3`, `NUL` and `PRN`.

In the R&S Microwave Signal Generator all files in which lists and settings are stored are given a characteristic extension. The extension is separated from the actual file name by a dot (see [chapter 4.7.2.1, "Extensions for User Files"](#), on page 82 for an overview the file types).

The two characters "*" and "?" function as "wildcards", i.e. they are used for selecting several files. The "?" character represents exactly one character, while the "*" character represents all characters up to the end of the file name. "*.*" therefore stands for all the files in a directory.

When used in conjunction with the commands, the parameter `<file_name>` is specified as a string parameter with quotation marks. It can contain either the complete path including the drive, only the path and file name, or only the file name. The file name must include the file extension. The same applies for the parameters `<directory_name>` and `<path>`.

Depending on how much information is provided, either the values specified in the parameter or the values specified with the command `MMEM:CDIR` (default directory) are used for the path and drive setting in the commands.

Before the instrument settings can be stored in a file, they have to be stored in an intermediate memory using common command `*SAV <number>`. The specified number is subsequently used in the `:MMEMory:STORe:STATe` command. Also, subsequently to loading a file with instrument settings with command `:MMEMory:LOAD:STATe`, these settings have to be activated with the common command `*RCL <number>`.

7.9.2 Extensions for User Files

The following table list all available file extensions for user files. The currently available files on the instrument depends on the installed options.

Table 7-1: List of the automatically assigned file extensions in the instrument

Function	List type	Contents	File suffix
Instrument State	Settings	Instrument settings	*.savrltxt
"User Correction"	List	User-defined level correction values	*.uco
		Export Data	*.txt or *.csv
"List Mode"	List	User-defined frequency/level value pairs	*.lsw
		Export Data	*.txt or *.csv
"Pulse Train List"		User-defined offtime/ontime/repetition values	*.pulstrn
ARB Waveform		ARB Waveform	*.wv
SMZ Settings	Settings	Data (firmware) of a connected SMZ frequency multiplier	*.efmfirm
NRP Settings	Settings	NRP Settings	*.nrp

7.9.3 Examples

In these examples, the current instrument setting is stored in the file `test1.savrltxt` in the directory `user`.

Storing and Loading Current Settings

1. Store the current setting in an intermediate memory with number 4. This setting can be called using command `*RCL` and the associated number of the memory, e.g. `*RCL 4`.
`*SAV 4`
2. To store the settings in a file in a specific directory, specify the complete path.
`MMEM:STOR:STAT 4, "var/user/test.savrltxt"`
3. To store the settings in a file in the default drive, set the default drive and specify only the file name.
`MMEM:CDIR 'var/user'*SAV 4`
`MMEM:STOR:STAT 4, "test.savrltxt"`
4. Load the file `test.savrltxt` in the `user` directory.
`MMEM:LOAD:STAT 4, '/var//user/test.savrltxt'`
5. Activate the instrument setting of the file `test.savrltxt`.
`*RCL 4`

Working with Files and Directories

1. Read out all files in the specified directory.
`MMEM:CAT? '/usb/user'`

Response: 127145265,175325184,"test,DIR,0","temp,DIR,0","readme.txt,ASC,1324","state.savrcltxt,STAT,5327","waveform.wv,BIN,2342"

the directory `/usb/user` contains the subdirectories `test` and `temp` as well as the files `readme.txt`, `state.savrcltxt` and `waveform.wv` which have different file types.

Tip: To query only the subdirectories of the current or specified directory, perform:
`MMEM:DCAT? '/usb/user'`

Response: 'test', 'temp'

To query only the number of subdirectories in the current or specified directory, perform:

`MMEM:DCAT:LENG? '/usb/user'`

Response: 2

2. To query the number of files in the current or specified directory, perform:

`MMEM:CAT:LENG? '/usb/user'`

Response: 3

3. Create a new subdirectory for mass memory storage in the specified directory.

`MMEM:MDIR '/usb/user/new'`

4. Copy the file `state` to a new file.

`MMEM:COPY '/var//user/state.savrcltxt','/usb/user/new'`

5. Rename the file `state`.

`MMEM:MOVE 'state.savrcltxt','state_new.savrcltxt'`

6. Remove the `test` directory.

`MMEM:RDIR '/usb/user/test'`

7.9.4 Remote Control Commands

:MMEMory:CATalog	328
:MMEMory:CATalog:LENGth	328
:MMEMory:CDIRectory	328
:MMEMory:COPIE	329
:MMEMory:DATA	329
:MMEMory:DCATalog	330
:MMEMory:DCATalog:LENGth	330
:MMEMory:DELeTe	330
:MMEMory:LOAD:STATe	331
:MMEMory:MDIRectory	331
:MMEMory:MOVE	331
:MMEMory:MSIS	332
:MMEMory:RDIRectory	332
:MMEMory:STORe:STATe	332

:MMEMory:CATalog? <path>

Returns the content of the current or a specified directory.

Query parameters:

<path> string
String parameter to specify the directory. If the directory is omitted, the command queries the content of the current directory, queried with `MMEM:CDIR` command.

Return values:

<path> <used_memory>,<free_memory>,<file_name>,<file_entry>,...
<used_memory>
Total amount of storage currently used in the directory, in bytes.
<free_memory>
Total amount of storage available in the directory, in bytes.
<file_entry>
All files of the directory are listed with their file name, format and size in bytes.

Example: See ["Working with Files and Directories"](#) on page 326.

Usage: Query only

:MMEMory:CATalog:LENGth?

Returns the number of files in the current or in the specified directory.

Return values:

<Length> <path>
String parameter to specify the directory. If the directory is omitted, the command queries the content of the current directory, queried with `MMEM:CDIR` command.

<count> Number of files

Example: See ["Working with Files and Directories"](#) on page 326.

Usage: Query only

:MMEMory:CDIRectory <Cdirectory>

Changes the default directory for mass memory storage. The directory is used for all subsequent `MMEM` commands if no path is specified with them. It is also possible to change to a higher directory using two dots '..'.

Setting parameters:

<Cdirectory> <directory_name>

Example: See ["Working with Files and Directories"](#) on page 326.

Usage: Setting only
SCPI confirmed

:MMEMory:COPY <file_source>[,<file_destination>]

Copies an existing to a new file. Instead of just a file, this command can also be used to copy a complete directory together with all its files.

It is also possible to specify the path using another parameter. The command is:

```
MMEMory:COPY
<file_source><msus_source>[,<file_destination>,
<msus_destination>]
```

Setting parameters:

<file_source>	string String parameter to specify the name of the file to be copied. If <destination> is not specified, <source> is copied to the MMEM:CDIR directory. Files which already exist with the same name in the destination directory are overwritten without an error message. It is also possible to specify the path using another parameter. The command is: MMEMory:COPY <file_source><msus_source>[,<file_destination>, <msus_destination>]
file_destination	string String parameter to specify the name of the new file. If no file destination is specified, the source file is copied to the current directory, queried with the MMEM:CDIR command. Files which already exist with the same name in the destination directory are overwritten without an error message.

Example: See "[Working with Files and Directories](#)" on page 326.

Usage: Event
SCPI confirmed

:MMEMory:DATA <file_name>[,<binary block data>]

:MMEMory:DATA? <file_name>

Writes the block data <binary block data> to the file identified by <file_name>. The IEC/IEEE-bus terminator should be set to EOI in order to ensure correct data transfer.

The associated query command transfers the specified file from the instrument to the IEC/IEEE bus and then on to the control computer. It is important to ensure that the intermediate memory on the control computer is large enough to take the file. In this case, the setting for the IEC/IEEE-bus terminator is irrelevant. This command can be used to read/transfer stored instrument settings or waveforms directly from/to the instrument.

Parameters:

<file_name>	String parameter to specify the name of the file.
--------------------------	---

Setting parameters:

<binary block data> #<number><length entry><block data>
 # always comes first in the binary block
 <number> the first digit indicates how many digits the subsequent length entry has
 <length entry> indicates the number of subsequent bytes
 <binary block data> binary block data for the specified length.

Example:

```
MMEM:DATA 'TEST1.WV',#3767<binary data>
writes the block data to the file test1.wv.
The digit "3" indicates a length entry of 3 digits; the digits "767"
indicate a length of the binary data in bytes.
MMEM:DATA? 'TEST1.WV'
sends the data of the file Test1.wv from the instrument to the
controller in the form of a binary block.
```

:MMEMory:DCATalog?

Returns the subdirectories of the current or specified directory.

Query parameters:

<path_name> String parameter to specify the directory. If the directory is omitted, the command queries the content of the current directory, queried with `MMEM:CDIR` command.

Return values:

<Dcatalog> <file_entry>
 Names of the subdirectories separated by colons. The first two strings are related to the parent directory.

Example: See "[Working with Files and Directories](#)" on page 326.

Usage: Query only

:MMEMory:DCATalog:LENGth? [<path_name>]

Returns the number of subdirectories in the current or specified directory.

Query parameters:

<path_name> String parameter to specify the directory. If the directory is omitted, the command queries the contents of the current directory, to be queried with `MMEM:CDIR` command.

Return values:

<file_entry_count> Number of parent and subdirectories.

Example: See "[Working with Files and Directories](#)" on page 326.

:MMEMory:DELeTe <Delete>

Removes a file from the specified directory.

Setting parameters:

<Delete> <file_name>
String parameter to specify the name and directory of the file to be removed.

Example: See "[Working with Files and Directories](#)" on page 326.

Usage: Event
SCPI confirmed

:MMEMory:LOAD:STATE <sav_rcl_state_number>, <file_name>

This command loads the specified file stored under the specified name in an internal memory.

After the file has been loaded, the instrument setting must be activated using an *RCL command.

Setting parameters:

<sav_rcl_state_number> Determines to the specific <number> to be used with the *RCL command, e.g. *RCL 4.

<file_name> String parameter to specify the file name with extension *.savrcltxt.

Example: See "[Storing and Loading Current Settings](#)" on page 326.

Usage: Setting only

:MMEMory:MDIRECTory <directory_name>

Creates a new subdirectory for mass memory storage in the specified directory. If no directory is specified, a subdirectory is created in the default directory. This command can also be used to create a directory tree.

Setting parameters:

<directory_name> string
String parameter to specify the new directory.

Example: See "[Working with Files and Directories](#)" on page 326.

Usage: Setting only

:MMEMory:MOVE <file_source>, <file_destination>

Moves an existing file to a new location or, if no path is specified, renames an existing file.

It is also possible to specify the path using another parameter. The command is:

```
MMEMory:MOVE
file_source,msus_source[, file_destination, msus_destination]
```

Setting parameters:

<file_source> String parameter to specify the name of the file to be moved.

<file_destination> String parameters to specify the name of the new file.

Example: See ["Working with Files and Directories"](#) on page 326.

Usage: Setting only
SCPI confirmed

:MMEMory:MSIS <Msis>

The command is without effect for the Linux operating system.

Usage: SCPI confirmed

:MMEMory:RDIRECTory <Rdirectory>

Removes an existing directory from the mass memory storage system. If no directory is specified, the subdirectory with the specified name is deleted in the default directory.

Setting parameters:

<Rdirectory> string
String parameter to specify the directory to be deleted.

Example: See ["Working with Files and Directories"](#) on page 326.

Usage: Setting only

:MMEMory:STORe:STATe <sav_rcl_state_number>, <file_name>

Stores the current instrument setting in the specified file.

The instrument setting must first be stored in an internal memory with the same number using the common command *SAV.

Setting parameters:

<sav_rcl_state_number> Corresponds to the specific <number> defined with the *SAV command, e.g. *SAV 4.

<file_name> String parameter to specify the file name with extension *.savrcltxt.

Example: See ["Storing and Loading Current Settings"](#) on page 326.

Usage: Event

7.10 OUTPut Subsystem

The OUTPut system contains the commands which set the properties of the RF output connector.

The properties of the LF output connector are set in the [chapter 7.12.8, "SOURCE:LFOutput Subsystem"](#), on page 420 system.

:OUTPut:ALL[:STATe].....	333
:OUTPut<hw>:AFIXed:RANGe:LOWer.....	333
:OUTPut<hw>:AFIXed:RANGe:UPPer.....	333
:OUTPut<hw>:ALC:SEARch:MODE.....	334
:OUTPut<hw>:AMODe.....	334
:OUTPut:BLANK:MODE.....	334
:OUTPut:BLANK:POLarity.....	335
:OUTPut:BLANK:WIDTh.....	335
:OUTPut:FPRoportional:SCALE.....	335
:OUTPut<hw>[:STATe].....	335
:OUTPut<hw>[:STATe]:PON.....	336

:OUTPut:ALL[:STATe] <State>

The command switches on or off all RF output signals of the instrument.

Parameters:

<State> 0 | 1 | OFF | ON
 *RST: OFF

Example:

OUTP:ALL OFF
 switches off all RF output signals.

:OUTPut<hw>:AFIXed:RANGe:LOWer?

The command queries the minimum level which can be set without the attenuator being adjusted (Attenuator FIXed).

Return values:

<Lower> float
 Default unit: dBm

Example:

OUTP:AFIX:RANG:LOW
 queries the minimum level for the FIXed setting.

Example:

Response: -50
 The minimum level is -50 dBm.

Usage:

Query only

:OUTPut<hw>:AFIXed:RANGe:UPPer?

The command queries the maximum level which can be set without the attenuator being adjusted (Attenuator FIXed).

Return values:

<Upper> float
 Default unit: dBm

Example: `OUTP:AFIX:RANG:UPP`
queries the maximum level for the FIXed setting for the RF output.

Example: `Response: -27`
The maximum level is -27 dBm.

Usage: Query only

:OUTPut<hw>:ALC:SEARch:MODE <Mode>

The command activates/deactivates the RF output during the power search.

Parameters:

<Mode> `NORMal | MINimum`
*RST: `OFF`

Example: `POW:ALC:SEAR:MODE NORM`
during the power search, the RF output is active.

:OUTPut<hw>:AMODE <Amode>

The command switches the mode of the attenuator at the RF output (Attenuator MODE).

Parameters:

<Amode> `AUTO | FIXed`

AUTO

The mechanical switching attenuator switches in steps of 10 dB at fixed points.

FIXed

The level settings are made without switching the attenuator or the relays. When this operating mode is switched on, the attenuator and the relays are fixed in their current positions and the resulting variation range is defined.

*RST: `AUTO`

Example: `POW:ALC ON`
activates automatic level control for RF output.
`OUTP:AMOD FIX`
sets the fixed mode with uninterrupted level for RF output.

:OUTPut:BLANK:MODE <Mode>

The command selects the RF blanking method for sweeps with step widths less than 10 MHz.

Parameters:

<Mode> `OFF | AUTO | ON`
*RST: `AUTO`

Example: `OUTP:BLAN:MODE AUTO`
 blanking is performed only when the step synthesizer switches to the next step.

:OUTPut:BLANK:POLarity <Polarity>

The command sets the polarity of the No Signal (Blank) Marker.

Parameters:

<Polarity> `NORMal | INVerted`
 *RST: `NORMal`

Example: `OUTP:BLAN:POL NORM`

:OUTPut:BLANK:WIDTH <Width>

The command selects the width of the blank marker.

Parameters:

<Width> `RFBLanking | TRIGrf`

RFBLanking

The blank marker starts after the external sweep trigger signal.

TRIGrf

The blank marker starts already with the external sweep trigger signal.

*RST: `RFBL`

Example: `OUTP:BLAN:MODE RFBL`
 the blank marker starts after the trigger signal.

:OUTPut:FPRoportional:SCALE <Scale>

The command selects the V/GHz ratio for the output.

Parameters:

<Scale> `S0V5 | S1V0`
 *RST: `S1V0`

Example: `OUTP:FPR:SCAL S0V5`
 sets the V/GHz ratio for the output to 0.5.

:OUTPut<hw>[:STATE] <State>

This command activates and deactivates the RF output.

Parameters:

<State> `0 | 1 | OFF | ON`

Example: `OUTP OFF`
 deactivates the RF output.

Usage: SCPI confirmed

:OUTPut<hw>[:STATe]:PON <Pon>

This command selects the state which the RF output assumes when the instrument is switched on.

Parameters:

<Pon> OFF | UNCHanged

OFF

The output is deactivated when the instrument is switched on.

UNCHanged

When the instrument is switched on, the output remains in the same state as it was when the instrument was switched off.

Example:

OUTP:PON OFF

RF output A is deactivated when the instrument is switched on.

7.11 Power Sensor Measurement Subsystems

The power sensor measurement uses several subsystems:

- The `CALCulate` subsystem is used to configure the time gated measurements in power analysis.
- The `DISPlay` subsystem is used to configure the diagram appearance.
- The `INITiate` command switches the local state of the continuous power measurement on and off.
- The `READ` system is used to start and to retrieve the measurement result of the power viewer measurement.
- The `SENSe` subsystem contains the commands for configuring the power viewer and power analysis measurements with power sensors connected to the generator. Up to three sensors can be connected to the signal generator.
- The `TRACe` subsystem is used to configure the traces in power analysis and to retrieve the measurement results.

Power Viewer

The power viewer measurement is started with the `READ` command, this command also retrieves the measurement results.

The sensors are distinguished by means of the suffix under `SENSe`:

- Power sensor connected to the `SENSOR` port = `SENSe[1]`
- First Power sensor connected to the `USB` interface = `SENSe2`
- Second Power sensor connected to the `USB` interface = `SENSe3`

Third Power sensor connected to the `USB` interface = `SENSe4`

Power and Pulse Data Analysis, Gated Measurements (option R&S SMF-K28)



Pulse data analysis in time measurement mode is available with power sensors R&S NRP-Z81.

The power analysis measurement commands are subsumed under the `SENSe[:POWER]:SWEep:...` commands. Three measurement modes are available: Frequency, Power and Time.

The power analysis measurement is started with the `SENSe[:POWER]:SWEep:INITiate` command and the measurement result retrieved with the `TRACe[:POWER]:SWEep:...` commands.

The four sensors are distinguished by means of the suffix at the second key word `SENSe`.

The time gate settings are performed using the `CALCulate[:POWER]:SWEep:...` commands.

The measurement diagram and results can be stored in a hardcopy with the `SENSe[:POWER]:SWEep:HCOpy:...` commands.

General parameter and measurement settings are valid for all connected sensors, therefore, no suffix is used in these commands.

7.11.1 CALCulate Subsystem

<code>:CALCulate[:POWER]:SWEep:TIME:GATE<ch>AVERage</code>	337
<code>:CALCulate[:POWER]:SWEep:TIME:GATE<ch>FEED</code>	338
<code>:CALCulate[:POWER]:SWEep:TIME:GATE<ch>MAXimum</code>	338
<code>:CALCulate[:POWER]:SWEep:TIME:GATE<ch>START</code>	339
<code>:CALCulate[:POWER]:SWEep:TIME:GATE<ch>STATE</code>	339
<code>:CALCulate[:POWER]:SWEep:FREQuency:MATH<ch>:STATE</code>	339
<code>:CALCulate[:POWER]:SWEep:FREQuency:MATH<ch>:SUBTract</code>	339
<code>:CALCulate[:POWER]:SWEep:POWER:MATH<ch>:STATE</code>	340
<code>:CALCulate[:POWER]:SWEep:POWER:MATH<ch>:SUBTract</code>	340
<code>:CALCulate[:POWER]:SWEep:TIME:MATH<ch>:STATE</code>	340
<code>:CALCulate[:POWER]:SWEep:TIME:MATH<ch>:SUBTract</code>	341

`:CALCulate[:POWER]:SWEep:TIME:GATE<ch>AVERage?`

This command queries the average power value of the time gated measurement.

Return values:

<code><Average></code>	float
	Range: -1000 to 1000
	Increment: 1E-12
	*RST: 0

Example: SENS : SWE : MODE TIME
 activates time mode for power analysis.
 CALC : SWE : TIME : GATE : STAT ON
 activates time gated measurement.
 SENS : SWE : INIT
 activates a single power analysis measurement.
 CALC : SWE : TIME : GATE2 : AVER?
 queries the average power in time gate 2 for trace 1 (=default).

Usage: Query only

Options: Option R&S SMF-K28

:CALCulate[:POWer]:SWEep:TIME:GATE<ch>:FEED <Feed>

This command selects the trace for time gated measurement. Both gates are assigned to the same trace.

Parameters:

<Feed> TRACe1 | TRACe2 | TRACe3
 *RST: TRACe1

Example: CALC : SWE : TIME : GATE : FEED TRAC2
 assigns the gates to trace 2.

Options: Option R&S SMF-K28

:CALCulate[:POWer]:SWEep:TIME:GATE<ch>MAXimum?

This command queries the average power value of the time gated measurement.

Return values:

<Maximum> float
 Range: -1000 to 1000
 Increment: 1E-12
 *RST: 0

Example: SENS : SWE : MODE TIME
 activates time mode for power analysis.
 CALC : SWE : TIME : GATE : STAT ON
 activates time gated measurement.
 SENS : SWE : INIT
 activates a single power analysis measurement.
 CALC : SWE : TIME : GATE2 : MAX?
 queries the peak power in time gate 2 for trace 1 (=default).

Usage: Query only

Options: Option R&S SMF-K28

:CALCulate[:POWER]:SWEep:TIME:GATE<ch>STARt <Start>

This command sets the start time of the selected gate. Insert value and unit.

Parameters:

<Start> float
 Increment: 1E-12
 *RST: Start/Stop: 5/15 (Gate1), 25/35 (Gate2)
 Default unit: μ s

Example: CALC:SWE:TIME:GATE2:STAR 20us
 sets a start time of 20 us for gate 2.

Example: CALC:SWE:TIME:GATE2:STOP 30us
 sets a stop time of 30us for gate 2.

Options: Option R&S SMF-K28

:CALCulate[:POWER]:SWEep:TIME:GATE<ch>:STATe <State>

This command activates gate settings for the selected trace. The measurement ist started with command SENS:POW:INIT. Both gates are active at one time.

Parameters:

<State> 0 | 1 | OFF | ON
 *RST: OFF

Example: CALC:SWE:TIME:GATE:STAT ON
 'enables time gated measurement.

Options: Option R&S SMF-K28

:CALCulate[:POWER]:SWEep:FREQuency:MATH<ch>:STATe <State>

This command activates / deactivates the trace mathematics mode for "Frequency" measurement. This feature enables to calculate the difference between the measurement values of two traces. Additionally, for further calculation a math result can also be assigned to a trace.

Parameters:

<State> 0 | 1 | OFF | ON
 *RST: 0

Example: CALC:POW:SWE:FREQ:MATH2:STATe

Example: switches on math mode in trace 2.

Options: R&S SMF-K28

:CALCulate[:POWER]:SWEep:FREQuency:MATH<ch>:SUBTract <Subtract>

This command executes the subtraction of the operands 1 and 2 and assigns the result to the selected trace in "Frequency" measurement mode.

Parameters:

<Subtract> T1T1 | T1T2 | T1T3 | T1T4 | T1REF | T2T1 | T2T2 | T2T3 | T2T4 | T2REF | T3T1 | T3T2 | T3T3 | T3T4 | T3REF | T4T1 | T4T2 | T4T3 | T4T4 | T4REF

Example:

CALC:POW:SWE:FREQ:MATH4:SUBT T2REF

Example:

Subtracts the **Reference** and **Trace 2**, and assigns the result to **Trace 4**. The resulting curve is shown in the diagram.

Options:

R&S SMF-K28

:CALCulate[:POWer]:SWEep:POWer:MATH<ch>:STATe <State>

This command activates / deactivates the trace mathematics mode for "Power" measurement. This feature enables to calculate the difference between the measurement values of two traces. Additionally, for further calculation a math result can also be assigned to a trace.

Parameters:

<State> 0 | 1 | OFF | ON
*RST: 0

Example:

CALC:POW:SWE:POW:MATH2:STATE

Example:

switches on math mode in trace 2.

Options:

R&S SMF-K28

:CALCulate[:POWer]:SWEep:POWer:MATH<ch>:SUBTRACT <Subtract>

This command executes the subtraction of the operands 1 and 2 and assigns the result to the selected trace in "Power" measurement mode.

Parameters:

<Subtract> T1T1 | T1T2 | T1T3 | T1T4 | T1REF | T2T1 | T2T2 | T2T3 | T2T4 | T2REF | T3T1 | T3T2 | T3T3 | T3T4 | T3REF | T4T1 | T4T2 | T4T3 | T4T4 | T4REF

Example:

CALC:POW:SWE:POW:MATH4:SUBT T2REF

Example:

Subtracts the **Reference** and **Trace 2**, and assigns the result to **Trace 4**. The resulting curve is shown in the diagram.

Options:

R&S SMF-K28

:CALCulate[:POWer]:SWEep:TIME:MATH<ch>:STATe <State>

This command activates / deactivates the trace mathematics mode for "Time" measurement. This feature enables to calculate the difference between the measurement values of two traces. Additionally, for further calculation a math result can also be assigned to a trace.

Parameters:

<State> 0 | 1 | OFF | ON
 *RST: 0

Example:

CALC:POW:SWE:TIME:MATH1:STATe

Example:

switches on math mode.

Options:

R&S SMF-K28

:CALCulate[:POWER]:SWEep:TIME:MATH<ch>:SUBTract <Subtract>

This command executes the subtraction of the operands 1 and 2 and assigns the result to the selected trace in "Time" measurement mode.

Parameters:

<Subtract> T1T1 | T1T2 | T1T3 | T1T4 | T1REF | T2T1 | T2T2 | T2T3 | T2T4 |
 T2REF | T3T1 | T3T2 | T3T3 | T3T4 | T3REF | T4T1 | T4T2 | T4T3 |
 T4T4 | T4REF

Example:

CALC:POW:SWE:TIME:MATH4:SUBT T2REF

Example:

Subtracts the **Reference** and **Trace 2**, and assigns the result to **Trace 4**. The resulting curve is shown in the diagram.

Options:

R&S SMF-K28

7.11.2 DISPlay Subsystem

:DISPlay[:WINDow][:POWER]:SWEep:BACKground:COLor.....341

:DISPlay[:WINDow][:POWER]:SWEep:GRID:STATe.....341

:DISPlay[:WINDow][:POWER]:SWEep:BACKground:COLor <Color>

This command defines the background color of the measurement diagram. The background color is also effective for the hardcopy of the diagram.

Parameters:

<Color> BLACK | WHITE
 *RST: BLACK

Example:

DISP:SWE:BACK:COL WHIT
 the measurement is indicated with a white background.

:DISPlay[:WINDow][:POWER]:SWEep:GRID:STATe <State>

This command activates/deactivates the indication of a grid in the diagram area..

Parameters:

<State> 0 | 1 | OFF | ON
 *RST: 1

Example: `DISP:SWE:GRID:STAT OFF`
deactivates the indication of a grid in the diagram area.

7.11.3 INITiate Command

:INITiate<ch>[:POWER]:CONTInuous <Continuous>

The command switches the local state of the continuous power measurement by the R&S NRP-Zxx power sensors on and off. Switching the local state off enhances the measurement performance during remote control

The remote measurement is triggered by the READ query (command `:READ<ch>[:POWER]` on page 342) which also provides the measurement results. The local state is not influenced by this command, measurements results can be retrieved with local state on or off.

Parameters:

<Continuous> 0 | 1 | OFF | ON
*RST: OFF

Example: `INIT:CONT ON`
switches local state of continuous power measurement on.

7.11.4 READ Subsystem

:READ<ch>[:POWER]?

The command triggers the measurement with power sensors and provides the power measurement result of the selected power sensor. The value is provided with the unit set with command `SENSe:UNIT[:POWER]`.

For certain power sensors, e.g. R&S NRP-Z81, two values are returned, first the value for the average level and - separated by a comma - the peak level

Note: The local state is not influenced by this command, measurements results can be retrieved with local state on or off. For long measurement times it is recommended to use a SRQ (MAV bit) for command synchronization.

Suffix:

<ch> 1..3

Return values:

<Power> string

Example:	<p>SENS:UNIT DBM selects unit dBm for presentation of measurement result.</p> <p>READ1? queries the measurement result of the sensor connected to the SENSOR interface.</p> <p>Response: -45.6246576745440230 -45.6 dBm were measured at the given frequency. or e.g. for R&S NRP-Z81</p> <p>Response: -55.62403263352178, -22.419472478812476 -55.6 dbm is the measured average level, -22.4 dBm is the measured peak level at the given frequency</p>
Usage:	Query only

7.11.5 SENSE Subsystem

SENSe<ch>[:POWer]:CORREction:SPDeVice:STATe.....	345
SENSe<ch>[:POWer]:DISPlay:PERManent:PRiority.....	345
SENSe<ch>[:POWer]:DISPlay:PERManent:STATe.....	346
SENSe<ch>[:POWer]:FILTer:LENGth:AUTO.....	346
SENSe<ch>[:POWer]:FILTer:LENGth[:USER].....	346
SENSe<ch>[:POWer]:FILTer:NSRatio.....	347
SENSe<ch>[:POWer]:FILTer:NSRatio:MTIME.....	347
SENSe<ch>[:POWer]:FILTer:SONCe.....	347
SENSe<ch>[:POWer]:FILTer:TYPE.....	348
SENSe<ch>[:POWer]:FREQuency.....	348
SENSe<ch>[:POWer]:OFFSet.....	349
SENSe<ch>[:POWer]:OFFSet:STATe.....	349
SENSe<ch>[:POWer]:SNUMber.....	349
SENSe<ch>[:POWer]:SOURce.....	349
SENSe<ch>[:POWer]:STATus[:DEVice].....	350
SENSe<ch>[:POWer]:SVERsion.....	350
SENSe[:POWer]:SWEep:ABORT.....	350
:SENSe[:POWer]:SWEep:FREQuency:REFerence:DATA:COpy.....	351
:SENSe[:POWer]:SWEep:FREQuency:REFerence:DATA:POINts.....	351
:SENSe[:POWer]:SWEep:FREQuency:REFerence:DATA:XVALues.....	351
:SENSe[:POWer]:SWEep:FREQuency:REFerence:DATA:YVALues.....	351
:SENSe[:POWer]:SWEep:FREQuency:RMODE.....	352
:SENSe<ch>[:POWer]:SWEep:FREQuency[:SENSor]:OFFSet.....	352
:SENSe<ch>[:POWer]:SWEep:FREQuency[:SENSor]:OFFSet:STATe.....	352
:SENSe<ch>[:POWer]:SWEep:FREQuency[:SENSor]:SRANge[:STATe].....	353
:SENSe<ch>[:POWer]:SWEep:FREQuency[:SENSor]:SRANge:STARt.....	353
:SENSe<ch>[:POWer]:SWEep:FREQuency[:SENSor]:SRANge:STOP.....	353
:SENSe[:POWer]:SWEep:FREQuency:SPACing[:MODE].....	354
:SENSe[:POWer]:SWEep:FREQuency:STARt.....	354
:SENSe[:POWer]:SWEep:FREQuency:STEPs.....	354
:SENSe[:POWer]:SWEep:FREQuency:STOP.....	355
:SENSe[:POWer]:SWEep:FREQuency:TIMing[:MODE].....	355

:SENSe[:POWer]:SWEep:FREQuency:YSCale:AUTO.....	355
:SENSe[:POWer]:SWEep:FREQuency:YSCale:AUTO:RESet.....	356
:SENSe[:POWer]:SWEep:FREQuency:YSCale:MAXimum.....	356
:SENSe[:POWer]:SWEep:FREQuency:YSCale:MINimum.....	357
SENSe[:POWer]:SWEep:HCOPY:DATA.....	357
SENSe[:POWer]:SWEep:HCOPY:DEVIce.....	358
SENSe[:POWer]:SWEep:HCOPY:DEVIce:LANGUage.....	359
SENSe[:POWer]:SWEep:HCOPY:DEVIce:LANGUage:CSV:DPOint.....	359
SENSe[:POWer]:SWEep:HCOPY:DEVIce:LANGUage:CSV:HEADer.....	359
SENSe[:POWer]:SWEep:HCOPY:DEVIce:LANGUage:CSV:ORientation.....	360
SENSe[:POWer]:SWEep:HCOPY:DEVIce:LANGUage:CSV[:COLumn]:SEParator.....	360
SENSe[:POWer]:SWEep:HCOPY:DEVIce:SIZE.....	360
SENSe[:POWer]:SWEep:HCOPY[:EXECute].....	361
SENSe[:POWer]:SWEep:HCOPY:FILE[:NAME].....	361
SENSe[:POWer]:SWEep:HCOPY:FILE[:NAME]:AUTO:DIRectory.....	362
SENSe[:POWer]:SWEep:HCOPY:FILE[:NAME]:AUTO:DIRectory:CLear.....	362
SENSe[:POWer]:SWEep:HCOPY:FILE[:NAME]:AUTO:FILE.....	362
SENSe[:POWer]:SWEep:HCOPY:FILE[:NAME]:AUTO[:FILE]:DAY.....	363
SENSe[:POWer]:SWEep:HCOPY:FILE[:NAME]:AUTO[:FILE]:DAY:STATe.....	363
SENSe[:POWer]:SWEep:HCOPY:FILE[:NAME]:AUTO[:FILE]:MONTH.....	363
SENSe[:POWer]:SWEep:HCOPY:FILE[:NAME]:AUTO[:FILE]:MONTH:STATe.....	364
SENSe[:POWer]:SWEep:HCOPY:FILE[:NAME]:AUTO[:FILE]:NUMBer.....	364
SENSe[:POWer]:SWEep:HCOPY:FILE[:NAME]:AUTO[:FILE]:PREFix.....	364
SENSe[:POWer]:SWEep:HCOPY:FILE[:NAME]:AUTO[:FILE]:PREFix:STATe.....	364
SENSe[:POWer]:SWEep:HCOPY:FILE[:NAME]:AUTO[:FILE]:YEAR.....	365
SENSe[:POWer]:SWEep:HCOPY:FILE[:NAME]:AUTO[:FILE]:YEAR:STATe.....	365
SENSe[:POWer]:SWEep:HCOPY:FILE[:NAME]:AUTO:STATe.....	365
:SENSe[:POWer]:SWEep:INITiate.....	366
SENSe[:POWer]:SWEep:MODE.....	366
:SENSe[:POWer]:SWEep:POWer:REFerence:DATA:COPIY.....	366
:SENSe[:POWer]:SWEep:POWer:REFerence:DATA:POINts.....	366
:SENSe[:POWer]:SWEep:POWer:REFerence:DATA:XVALues.....	367
:SENSe[:POWer]:SWEep:POWer:REFerence:DATA:YVALues.....	367
SENSe[:POWer]:SWEep:POWer:RMODE.....	367
:SENSe<ch>[:POWer]:SWEep:POWer[:SENSor]:OFFSet.....	367
:SENSe<ch>[:POWer]:SWEep:POWer[:SENSor]:OFFSet:STATe.....	368
SENSe<ch>[:POWer]:SWEep:POWer[:SENSor]:SFRequency.....	368
SENSe<ch>[:POWer]:SWEep:POWer[:SENSor]:SFRequency:STATe.....	368
:SENSe<ch>[:POWer]:SWEep:TIME[:SENSor]:OFFSet.....	368
:SENSe<ch>[:POWer]:SWEep:TIME[:SENSor]:OFFSet:STATe.....	369
:SENSe<ch>[:POWer]:SWEep:TIME[:SENSor]:PULSe:STATe.....	369
SENSe<ch>[:POWer]:SWEep:TIME[:SENSor]:PULSe:THReshold:BASE.....	369
:SENSe<ch>[:POWer]:SWEep:TIME[:SENSor]:PULSe:THReshold:POWer:HREFerence.....	370
:SENSe<ch>[:POWer]:SWEep:TIME[:SENSor]:PULSe:THReshold:POWer:REFerence.....	370
:SENSe<ch>[:POWer]:SWEep:TIME[:SENSor]:PULSe:THReshold:POWer:LREFerence.....	371
SENSe[:POWer]:SWEep:POWer:SPACing[:MODE].....	371
SENSe[:POWer]:SWEep:POWer:START.....	371
SENSe[:POWer]:SWEep:POWer:STEPS.....	371
SENSe[:POWer]:SWEep:POWer:STOP.....	372
SENSe[:POWer]:SWEep:POWer:TIMing[:MODE].....	372

SENSe[:POWer]:SWEep:POWer:YSCale:AUTO.....	372
SENSe[:POWer]:SWEep:POWer:YSCale:AUTO:RESet.....	373
SENSe[:POWer]:SWEep:POWer:YSCale:MAXimum.....	373
SENSe[:POWer]:SWEep:POWer:YSCale:MINimum.....	374
SENSe[:POWer]:SWEep:RMODe.....	374
SENSe[:POWer]:SWEep:TIME:RMODe.....	374
:SENSe[:POWer]:SWEep:TIME:AVERage[:COUNT].....	375
:SENSe[:POWer]:SWEep:TIME:REFErence:DATA:COpy.....	375
:SENSe[:POWer]:SWEep:TIME:REFErence:DATA:POINts.....	375
:SENSe[:POWer]:SWEep:TIME:REFErence:DATA:XVALues.....	375
:SENSe[:POWer]:SWEep:TIME:REFErence:DATA:YVALues.....	376
SENSe<ch>[:POWer]:SWEep:TIME[:SENSor]:SFRequency.....	376
SENSe<ch>[:POWer]:SWEep:TIME[:SENSor]:SFRequency:STATe.....	376
SENSe<ch>[:POWer]:SWEep:TIME[:SENSor]:TRIGger:AUTO.....	376
SENSe<ch>[:POWer]:SWEep:TIME[:SENSor]:TRIGger:DTIME.....	377
SENSe<ch>[:POWer]:SWEep:TIME[:SENSor]:TRIGger:HYSteresis.....	377
SENSe<ch>[:POWer]:SWEep:TIME[:SENSor]:TRIGger:LEVel.....	377
:SENSe<ch>[:POWer]:SWEep:TIME[:SENSor]:TRIGger:SLOPe.....	378
SENSe<ch>[:POWer]:SWEep:TIME[:SENSor]:TRIGger:SOURce.....	378
SENSe[:POWer]:SWEep:TIME:SPACing[:MODE].....	378
SENSe[:POWer]:SWEep:TIME:STARt.....	378
SENSe[:POWer]:SWEep:TIME:STEPs.....	379
SENSe[:POWer]:SWEep:TIME:STOP.....	379
:SENSe[:POWer]:SWEep:TIME:TEVents.....	379
SENSe[:POWer]:SWEep:TIME:YSCale:AUTO.....	380
SENSe[:POWer]:SWEep:TIME:YSCale:AUTO:RESet.....	380
SENSe[:POWer]:SWEep:TIME:YSCale:MAXimum.....	381
SENSe[:POWer]:SWEep:TIME:YSCale:MINimum.....	381
SENSe<ch>[:POWer]:TYPE.....	381
SENSe<ch>[:POWer]:ZERO.....	381
SENSe<ch>:UNIT[:POWer].....	382

SENSe<ch>[:POWer]:CORRection:SPDevice:STATe <State>

The command activates the use of the s-parameters correction data of the selected power sensor.

Note: For power sensor with attenuator this command is automatically set to ON.

Parameters:

<State> 0 | 1 | OFF | ON
 *RST: OFF

Example:

```
SENS:POW:CORR:SPD:STAT ON
activates the use of the s-parameters correction data of power
sensor 1.
```

SENSe<ch>[:POWer]:DISPlay:PERManent:PRIOrity <Priority>

The command selects which power measurement result (average or peak power) is indicated when permanent display is active.

Parameters:

<Priority> AVERAge | PEAK
 *RST: AVERAge

Example:

SENS1:DISP:PERM:STAT ON
 the permanent viewer is switched on.
 SENS1:DISP:PERM:PRI AVER
 the measured average power is indicated.

SENSe<ch>[:POWer]:DISPlay:PERManent:STATe <State>

The command switches on and off the permanent indication of the power measurement result in the upper right corner of the block diagram. For each sensor, the type of sensor, the connector, the measurement source and - if set - the offset is indicated.

Parameters:

<State> 0 | 1 | OFF | ON
 *RST: OFF

Example:

SENS1:POW:DISP:PERM:STAT ON
 the permanent viewer is switched on.

SENSe<ch>[:POWer]:FILTer:LENGth:AUTO?

The command queries the current filter length for auto filter mode
 (:SENSe<[1]...3>:POWer:FILTer:TYPE AUTO)

Return values:

<Auto> float

Example:

SENS1:FILT:TYPE AUTO
 selects auto filter mode for the power sensor connected to the
 SENSOR connector.
 SENS1:FILT:LENG:AUTO?
 queries the automatically set filter length.
 Response: 1024

Usage:

Query only

SENSe<ch>[:POWer]:FILTer:LENGth[:USER] <User>

The command selects the filter length for user filter mode
 (SENSe:POWer:FILTer:TYPE USER). As the filter length works as a multiplier for the
 time window, a constant filter length results in a constant measurement time. Values 1
 and 2ⁿ are settable.

The time window is fixed to 20 ms.

Parameters:

<User> float
 Range: 1 to 65536
 *RST: 1

Example: `SENS:FILT:TYPE USER`
 selects user filter mode.
 `SENS:FILT:LENG 16`
 sets a filter length of 16. The resulting measurement time is 640
 ms (2x16x20 ms).

SENSe<ch>[:POWER]:FILTer:NSRatio <Nsratio>

The command defines the noise content for fixed noise filter mode
 (:SENSe<[1]...3>:POWER:FILTer:TYPE NSRatio). This value determines the
 proportion of intrinsic noise in the measured result.

Parameters:

<Nsratio> float
 Range: 0.0001 to 1.0
 *RST: 0.01

Example: `SENS1:FILT:TYPE NSR`
 selects fixed noise filter mode for the power sensor connected to
 the SENSOR connector.
 `SENS1:FILT:NSR 0.2`
 sets a noise content of 0.2.

SENSe<ch>[:POWER]:FILTer:NSRatio:MTIME <Mtime>

The command defines the timeout for fixed noise filter mode
 (:SENSe<[1]...3>:POWER:FILTer:TYPE NSRatio). This value ensures limited
 settling times.

Parameters:

<Mtime> float
 Range: 1.0 to 999.99
 *RST: 4
 Default unit: s

Example: `SENS1:FILT:TYPE NSR`
 selects fixed noise filter mode for the power sensor connected to
 the SENSOR connector.
 `SENS1:FILT:NSR .2`
 sets a noise content of 0.2.
 `SENS1:FILT:NSR:MTIM 5`
 limits the settling time to 5 seconds

SENSe<ch>[:POWER]:FILTer:SONCe

The command activates the search for the optimum filter length for the current measure-
 ment conditions. The found filter length can be retrieved with com-
 mand :SENSe:POWER:FILTer:LENGth:USER?. This command is only available for
 user filter mode (:SENSe:POWER:FILTer:TYPE USER).

Example:

```

SENS:FILT:TYPE USER
selects user filter mode.
SENS:FILT:SONC
activates the search for the optimum filter length.
SENS:FILT:LENG?
returns the found optimum filter length.
Response: 128

```

Usage:

Event

SENSe<ch>[:POWER]:FILTer:TYPE <Type>

The command selects the filter mode. The filter length is the multiplier for the time window and thus directly influences the measurement time.

Parameters:

<Type>

AUTO | USER | NSRatio

AUTO

The filter length is automatically selected depending on the measured value. For high values, a short filter length is selected and for low values a long filter length is selected.

USER

The filter length is set manually. As the filter length works as a multiplier for the measurement time, this results in a constant measurement time.

NSRatio

The filter length (averaging factor) is selected so that the sensor's intrinsic noise (2 standard deviations) does not exceed the specified noise content. The desired noise content is entered with command `SENSe:FILTer:NSRatio`.

To avoid very long settling times when the power is low, the averaging factor can be limited with the Timeout parameter (command `SENSe:FILTer:NSRatio:MTIME`).

*RST: AUTO

Example:

```

SENS:FILT:TYPE AUTO
selects automatic filter selection.

```

SENSe<ch>[:POWER]:FREQuency <Frequency>

The command sets the RF frequency of the source if the user source is selected (`SENSe[:POWER]:SOURce USER`).

Parameters:

<Frequency>

float

*RST: 1 GHz

Example: `SENS:SOUR USER`
 selects user-defined source.
 `SENS:FREQ 2.44 GHz`
 enters the RF frequency of the source which is 2.44 GHz.

SENSe<ch>[:POWer]:OFFSet <Offset>

The command enters a level offset which is added to the measured level value after activation with command `SENSe[:POWer]:OFFSet:STATe ON`. This allows e.g. an attenuator in the signal path to be taken into account.

Parameters:

<Offset> float
 Range: -100.0 to 100.0
 *RST: 0
 Default unit: dB

Example: `SENS:POW:OFFS 10.0`
 sets a level offset of 10 dB

SENSe<ch>[:POWer]:OFFSet:STATe <State>

The command activates the addition of the level offset to the measured value. The level offset value is set with command `SENSe[:POWer]:OFFSet`.

Parameters:

<State> 0 | 1 | OFF | ON
 *RST: OFF

Example: `SENS1:POW:OFFS 0.4dB`
 sets a level offset of 0.4 dB
 `SENS1:POW:OFFS:STAT ON`
 a level offset of 0.4 dB is added to the measured value.

SENSe<ch>[:POWer]:SNUMber?

The command queries the serial number of the sensor.

Return values:

<Snumber> string

Example: `SENS:SNUM?`
 queries the serial number.

Usage: Query only

SENSe<ch>[:POWer]:SOURce <Source>

The command selects the signal source for the measurement.

Parameters:

<Source> A | B | USER
 *RST: A

Example:

SENS:SOUR A
 selects the RF signal as measurement source. The RF frequency is used as the measurement frequency of the sensor and the corresponding correction factor is used. The level setting of the instrument serves as reference level of the measurement.

SENSe<ch>[:POWER]:STATus[:DEVice]?

The command queries if a sensor is connected to the signal generator.

The sensor is selected by suffix in the keyword SENSe or READ of the command header. Suffix 1 denotes the sensor connected to the SENSOR connector, suffix 2 the sensor connected first to one of the USB interfaces and suffix 3 the sensor connected second to one of the USB interfaces.

Return values:

<DEVice> 0 | 1 | OFF | ON

Example:

SENS:STAT?
 queries if a sensor is connected to the instrument.
 Response: 1
 a sensor is connected to the POWER SENSOR interface.

Usage: Query only

SENSe<ch>[:POWER]:SVERsion?

The command queries the software version of the connected R&S NRP power sensor.

Return values:

<Sversion> string

Example:

SENS:POW:SVER?
 queries the software version of the R&S NRP power sensor.

Usage: Query only

SENSe[:POWER]:SWEep:ABORt <Abort>

This command aborts the power analysis with NRP power sensors.

Setting parameters:

<Abort>

Example:

SENS:SWE:ABOR;*OPC?
 aborts the current power measurement.

Usage: Setting only

Options: Option R&S SMF-K28

:SENSe[:POWer]:SWEep:FREQUency:REFerence:DATA:COpy

This command generates a reference curve for "Frequency" measurement.

Example: `SENS:POW:SWE:FREQ:REF:DATA:COpy`

Example: generates a reference curve in frequency mode.

Usage: Event

Options: R&S SMF-K28

:SENSe[:POWer]:SWEep:FREQUency:REFerence:DATA:POINts?

This command reads the number of points from the reference curve in "Frequency" measurement.

Return values:

<Points> integer
 Range: 10 to 1000
 Increment: 1

Example: `SENS:POW:SWE:FREQ:REF:DATA:POIN?`

Example: queries the number of points from the reference curve in frequency mode.

Usage: Query only

:SENSe[:POWer]:SWEep:FREQUency:REFerence:DATA:XVALues <XValues>

This command sets or queries the x values of the two reference points, i.e. "Frequency X (Point A)" and "Frequency X (Point B)" in "Frequency" measurement.

Parameters:

<XValues> string

Example: `SENSe:POW:SWE:FREQ:REF:DATA:XVAL 100MHZ,22GHZ`

Example: sets the x value of reference "Point A" to 10 MHz, and the value of "Point B" to 10 GHz.

Options: R&S SMF-K28

:SENSe[:POWer]:SWEep:FREQUency:REFerence:DATA:YVALues <YValues>

This command sets or queries the y values of the two reference points, i.e. "Pow Y (Point A)" and "Power Y (Point B)" in "Frequency" measurement.

Parameters:

<YValues> string

Example: `SENSe:POW:SWE:FREQ:REF:DATA:YVAL -10,25`

Example: sets the y value of reference "Point A" to -10 dBm, and the value of "Point B" to -25 dBm.

Options: R&S SMF-K28

:SENSe[:POWer]:SWEep:FREQuency:RMODe <RMode>

This command selects single or continuous mode for measurement mode frequency in power analysis.

Parameters:

<RMode> SINGle | CONTInuous
 *RST: CONTInuous

Example: SENS:SWE:FREQ:RMOD SING
 selects single measurement

Options: Option R&S SMF-K28

:SENSe<ch>[:POWer]:SWEep:FREQuency[:SENSor]:OFFSet <Offset>

Defines the level offset at the sensor input in dB. Activate the offset with the command `:SENSe<ch>[:POWer]:SWEep:FREQuency[:SENSor]:OFFSet:STATe`.

Parameters:

<Offset> float
 Range: -100 to 100
 Increment: 0.01
 *RST: 0

Example: SENS2:SWE:FREQ:OFFS -3dB
 defines a level offset of -3 dB.
 SENS2:SWE:FREQ:OFFS:STAT ON
 activates the specified level offset.

Options: Option R&S SMF-K28

:SENSe<ch>[:POWer]:SWEep:FREQuency[:SENSor]:OFFSet:STATe <State>

Activates a level offset at the sensor input. Define the appropriate value with the command `:SENSe<ch>[:POWer]:SWEep:FREQuency[:SENSor]:OFFSet`.

Parameters:

<State> 0 | 1 | OFF | ON
 *RST: 0

Example: SENS2:SWE:FREQ:OFFS:STAT ON
 activates the specified level offset.

Options: Option R&S SMF-K28

:SENSe<ch>[:POWer]:SWEep:FREQuency[:SENSor]:SRANge[:STATe] <State>

This command activates the use of a frequency range for the power measurement that is different to the set signal generator frequency range. The separate frequency range is entered with commands `SENS : SWE : FREQ : SENS : STAR` and `SENS : SWE : FREQ : SENS : STOp`.

Parameters:

<State> 0 | 1 | OFF | ON
 *RST: 1 MHz

Example:

`SENS2 : SWE : FREQ : SENS : SRAN ON`
 activates use of a separate frequency range for frequency versus power measurement for sensor 2.
`SENS2 : SWE : FREQ : SENS : STAR 2.0GHZ`
 sets a sweep start at 2 GHz irrespective of the current signal generator frequency settings.
`SENS2 : SWE : FREQ : SENS : STOP 2.9GHZ`
 sets a sweep stop at 2.9 GHz irrespective of the current signal generator frequency settings.

Options: Option R&S SMF-K28

:SENSe<ch>[:POWer]:SWEep:FREQuency[:SENSor]:SRANge:STARt <Start>

This command enters the start frequency for the frequency power analysis with separate frequencies.

Parameters:

<Start> integer
 Range: 0 to 1E12
 Increment: 1
 *RST: 1 MHz

Example:

`SENS2 : SWE : FREQ : SENS : SRAN : STAT ON`
 activates use of a separate frequency range for frequency versus power measurement for sensor 2.
`SENS2 : SWE : FREQ : SENS : STAR 2.0GHZ`
 sets a sweep start at 2 GHz irrespective of the current signal generator frequency settings.

Options: R&S SMF-K28

:SENSe<ch>[:POWer]:SWEep:FREQuency[:SENSor]:SRANge:STOP <Stop>

This command enters the stop frequency for the frequency power analysis with separate frequencies.

Parameters:

<Stop> integer
 Range: 0 to 1E12
 Increment: 1
 *RST: 22 GHz

Example:

SENS:SWE:FREQ:SENS2:SRAN:STAT ON
 activates use of a separate frequency range for frequency versus power measurement.
 SENS:SWE:FREQ:SENS2:STAR 2.0GHZ
 sets a sweep start at 2 GHz irrespective of the current signal generator frequency settings.
 SENS:SWE:FREQ:SENS2:STOP 2.9GHZ
 sets a sweep stop at 2.9 GHz irrespective of the current signal generator frequency settings.

Options: Option R&S SMF-K28

:SENSe[:POWer]:SWEep:FREQUency:SPACing[:MODE] <Mode>

This command selects the spacing for the frequency power analysis.

Parameters:

<Mode> LINear | LOGarithmic
 *RST: LINear

Example:

SENS:SWE:FREQ:SPAC:MODE LIN
 sets linear spacing of the sweep

Options: Option R&S SMF-K28

:SENSe[:POWer]:SWEep:FREQUency:STARt <Start>

This command enters the start frequency for the frequency mode.

Parameters:

<Start> float
 Range: 0 to 1E12
 *RST: 1.0 MHz

Example:

SENS:SWE:FREQ:STAR 2.0GHZ
 'sets a sweep start at 2 GHz.

Options: Option R&S SMF-K28

:SENSe[:POWer]:SWEep:FREQUency:STEPs <Steps>

This command enters the number of measurement steps for the frequency mode.

Parameters:

<Steps> integer
 Range: 10 to 1000
 *RST: 200

Example:

SENS:SWE:FREQ:STEP 500
 sets 500 steps

Options:

Option R&S SMF-K28

:SENSe[:POWer]:SWEep:FREQuency:STOP <Stop>

This command enters the stop frequency for the frequency mode.

Parameters:

<Stop> float
 Range: 0 to 1E12
 *RST: 22.0 GHz

Example:

SENS:SWE:FREQ:STOP 20.0GHZ
 sets the sweep stop to 20 GHz

Options:

Option R&S SMF-K28

:SENSe[:POWer]:SWEep:FREQuency:TIMing[:MODE] <Mode>

Selects the mode in terms of speed and precision of the response of a measurement.

Parameters:

<Mode> FAST | NORMAl | HPRecision

FAST

Selection FAST leads to a fast measurement with a short integration time for each measurement step.

NORMAl

NORMAl leads to a longer but more precise measurement due to a higher integration time for each step.

*RST: NORMAl

Example:

SENS:SWE:FREQ:TIM:MODE FAST
 the fast measurement mode is selected.

Options:

Option R&S SMF-K28

:SENSe[:POWer]:SWEep:FREQuency:YSCale:AUTO <Auto>

This command activates/deactivates autoscaling of the Y axis of the diagram.

Parameters:

<Auto>	OFF CEXPanding FEXPanding CFLoating FFLoating OFF Auto scaling is deactivated. If switching from activated to deactivated Auto scaling, the scaling is maintained. CEXPanding FEXPanding Auto scale is activated. The scaling of the Y-axis is selected in such a way, that the trace is always visible. To this end, the range is expanded if the minimum or maximum values of the trace move outside the current scale. The step width is 5 dB for selection course and variable in the range of 0.2 db to 5 dB for selection fine. CFLoating FFLoating Auto scale is activated. The scaling of the Y-axis is selected in such a way, that the trace is always visible. To this end, the range is either expanded if the minimum or maximum values of the trace move outside the current scale or scaled down if the trace fits into a reduced scale. The step width is 5 dB for selection course and variable in the range of 0.2 db to 5 dB for selection fine. *RST: CEXPanding
--------	--

Example:

```
SENS:SWE:FREQ:YSC:AUTO OFF
deactivates auto scale
```

Options:

Option R&S SMF-K28

:SENSe[:POWer]:SWEep:FREQuency:YSCale:AUTO:RESet

This command resets the Y scale to suitable values after the use of auto scaling in the expanding mode. For this mode, the scale might get expanded because of temporarily high power values. The reset function resets the diagram in such a way that it matches smaller power values again.

Example:

```
SENS:SWE:FREQ:YSC:AUTO:RES
resets auto scale
```

Usage:

Event

Options:

Option R&S SMF-K28

:SENSe[:POWer]:SWEep:FREQuency:YSCale:MAXimum <Maximum>

This command enters the maximum value for the y axis of the measurement diagram.

Parameters:

<Maximum>	float
Range:	-200 to 100
Increment:	0.01
*RST:	40.0 dBm

Example: `SENS:SWE:FREQ:YSC:MAX 10DBM`
sets 10 dBm as the upper limit of the measurement diagram.

Options: Option R&S SMF-K28

:SENSe[:POWer]:SWEep:FREQuency:YSCale:MINimum <Minimum>

This command enters the minimum value for the y axis of the measurement diagram.

Parameters:

<Minimum>	float
	Range: -200 to 100
	Increment: 0.01
	*RST: -40.0 dBm

Example: `SENS:SWE:FREQ:YSC:MIN -10DBM`
sets -10 dBm as the lower limit of the measurement diagram.

Options: Option R&S SMF-K28

SENSe[:POWer]:SWEep:HCOPy:DATA?

This command queries the measurement data directly. The data is transferred to the remote client as data stream, e.g. for further processing (see [chapter 6.3.3, "SCPI Parameters"](#), on page 287, description of block data).

Readable ASCII data is available for hardcopy language CSV. The representation of the values depends on the selected orientation for the CSV format.

Return values:

<Data>	string
--------	--------

Example:

```
SENS:SWE:HCOP:DEV:LANG CSV
```

selects output format *.csv.

```
SENS:SWE:HCOP:DEV:LANG:CSV:ORI HOR
```

selects horizontal orientation

```
SENS:SWE:HCOP:DEV:LANG:CSV:SEP SEM
```

selects ";" as the separator between the values

```
SENS:SWE:HCOP:DEV:LANG:CSV:DPO DOT
```

selects "." as decimal point

```
SENS:SWE:HCOP:DATA?
```

queries the measurement data of the current traces

Response:

```
#2651009500000;1019000000;1028500000;1038000000
```

```
-9.5;-9.7;-6.3;-2.5
```

The hash symbol # introduces the data block. The next number indicates how many of the following digits describe the length of the data block. In the example the 2 following digit indicates the length to be 65 characters.

Because horizontal representation is selected, a row with all the x-values of the active trace (frequency) follows. The second row contains all the y-values of the active trace (power). The rows end with a new line (each counts as one character).

Note: if more than one trace is active, the third row contains the x values of the second active trace, and so on.

Example:

```
SENS:SWE:HCOP:DEV:LANG:CSV:ORI VERT
```

selects horizontal orientation

```
SENS:SWE:HCOP:DATA?
```

queries the measurement data of the current traces

Response:

```
#2681009500000;-9.5; 1019000000;-9.7; 1028500000;-6.3;
```

```
1038000000;-2.5;
```

for vertical representation the length of the data block is 68 the first power value, the second row contains the second frequency value of the active trace followed by the second power value, and so on. The rows end with a new line (each counts as one character).

Note: if more than one trace is active, the first row also contains the value pairs of the second active trace, and so on.

Usage:

Query only

Options:

Option R&S SMF-K28

SENSe[:POWER]:SWEep:HCOPy:DEVIce <Device>

This command defines the output device. The setting is fixed to FILE, i.e. the hardcopy is stored in a file.

Parameters:

<Device>

FILE | PRINter

*RST: FILE

Example: `SENS:SWE:HCOP:DEV FIL`
selects output device file

Options: Option R&S SMF-K28

SENSe[:POWer]:SWEep:HCOPy:DEVIce:LANGUage <Language>

This command selects the bitmap graphic format for the screenshot of the power analysis trace.

In addition, ASCII file format `*.csv` is offered. If file format `*.csv` is selected, the trace data is saved as an ASCII file with comma separated values. It is also possible to directly retrieve the data using command `SENS:SWE:HCOP:DATA?`.

Parameters:

<Language> `BMP | JPG | XPM | PNG | CSV`
*RST: `BMP`

Example: `SENS:SWE:HCOP:DEV:LANG BMP`
selects output format `*.bmp`.

Options: Option R&S SMF-K28

SENSe[:POWer]:SWEep:HCOPy:DEVIce:LANGUage:CSV:DPOInt <Dpoint>

This command defines which character should be used as the decimal point of the values, either dot or comma.

Parameters:

<Dpoint> `DOT | COMMA`
*RST: `DOT`

Example: `SENS:SWE:HCOP:DEV:LANG CSV`
selects output format `*.csv`.
`SENS:SWE:HCOP:DEV:LANG:CSV:DPO DOT`
selects character dot for being used as decimal point.

Options: Option R&S SMF-K28

SENSe[:POWer]:SWEep:HCOPy:DEVIce:LANGUage:CSV:HEADer <Header>

This command defines whether each row (or column depending on the orientation) should be preceded by a header containing information about the trace (see also [SENSe\[:POWer\]:SWEep:HCOPy:DATA](#) on page 357).

Parameters:

<Header> `OFF | STANdard`
*RST: `OFF`

Example: `SENS:SWE:HCOP:DEV:LANG CSV`
 selects output format * . csv.
 `SENS:SWE:HCOP:DEV:LANG:CSV:HEAD STAN`
 selects the standard header for the * . csv file.

Options: Option R&S SMF-K28

SENSe[:POWER]:SWEep:HCOPy:DEVIce:LANGUage:CSV:ORientation
 <Orientation>

This command defines the orientation of the X/Y value pairs. For examples on how the data are arranged see "[CSV Options Hardcopy- Power Analysis](#)" on page 206.

Parameters:
 <Orientation> HORizontal | VERTical
 *RST: HORizontal

Example: `SENS:SWE:HCOP:DEV:LANG CSV`
 selects output format * . csv.
 `SENS:SWE:HCOP:DEV:LANG:CSV:ORI VERT`
 selects vertical orientation, the value pairs are written in a column
 like structure (separated by the selected separator, e.g. tab)

Options: Option R&S SMF-K28

SENSe[:POWER]:SWEep:HCOPy:DEVIce:LANGUage:CSV[:COLumn]:SEParator
 <Separator>

This command defines which character is to separate the values, either tabulator, semicolon, comma or blank.

Parameters:
 <Separator> TABulator | SEMicolon | COMMa | BLANK
 *RST: SEMicolon

Example: `SENS:SWE:HCOP:DEV:LANG CSV`
 selects output format * . csv.
 `SENS:SWE:HCOP:DEV:LANG:CSV:SEP TAB`
 a tab separates the values

Options: Option R&S SMF-K28

SENSe[:POWER]:SWEep:HCOPy:DEVIce:SIZE <Size>

This command sets the size of the hardcopy in number of pixels. The first value of the size setting defines the width, the second value the height of the image.

Parameters:
 <Size> 320,240 | 640,480 | 800,600 | 1024,768
 *RST: 320,240

Example: SENS:SWE:HCOP:DEV:LANG BMP
 selects output format *.bmp.
 SENS:SWE:HCOP:DEV:SIZE 320,240
 the size of the bitmap is 320 pixels by 240 pixels.

Options: Option R&S SMF-K28

SENSe[:POWer]:SWEep:HCOPy[:EXECute]

This command triggers the generation of a hardcopy of the current measurement diagram. The data is written into the file selected/created with the `SENSe[:POWer]:SWEep:HCOPy:FILE[:NAME]` command.

Example: SENS:SWE:HCOP:DEV:LANG BMP
 selects output format *.bmp.
 SENS:SWE:HCOP:FILE:AUTO:STAT OFF
 switches off automatic file naming.
 SENS:SWE:HCOP:FILE 'var/nrp_trace1'
 creates the file nrp_trace1.bmp in the set path.
 SENS:SWE:HCOP
 triggers the generation of a hardcopy of the current measurement diagram. The hardcopy is stored in the file nrp_trace1.bmp.

Usage: Event

Options: Option R&S SMF-K28

SENSe[:POWer]:SWEep:HCOPy:FILE[:NAME] <Name>

This command creates/selects a file into which the hardcopy will be stored after the `SENS:SWE:HCOP:EXEC` command is sent. The directory is either defined with the command `MMEMoRY:CDIR` or the path is specified together with the file name. Access to the file via remote control is possible using the commands of the MMEM-Subsystem. In contrast, command `SENSe:SWEep:HCOPy:DATA?` transfers the hardcopy contents directly to the remote client where they can be further processed.

Parameters:

<Name> string

Example: SENS:SWE:HCOP:DEV:LANG BMP
 selects output format *,bmp.
 SENS:SWE:HCOP:FILE:AUTO:STAT OFF
 switches off automatic naming.
 SENS:SWE:HCOP:FILE 'var/trace/nrp_trace1'
 creates the file nrp_trace1.bmp in the trace directory.
 SENS:SWE:HCOP:EXEC
 triggers the generation of a hardcopy of the current trace. The hardcopy is stored in the file nrp_trace1.bmp.

Options: Option R&S SMF-K28

SENSe[:POWer]:SWEep:HCOPy:FILE[:NAME]:AUTO:DIRectory <Directory>

This command defines the directory into which the hardcopy files will be stored if auto naming is activated (SENS:SWE:HCOP:FILE:AUTO:STAT ON).

Parameters:

<Directory> string

Example:

SENS:SWE:HCOP:FILE:AUTO:DIR 'var/nrp'
hardcopy file are stored in directory var/nrp if automatic naming is activated.

Options:

Option R&S SMF-K28

SENSe[:POWer]:SWEep:HCOPy:FILE[:NAME]:AUTO:DIRectory:CLEar

This command deletes all files with extensions bmp , img, png, xpm and csv in the directory set for automatic naming.

Example:

SENS:SWE:HCOP:FILE:AUTO:DIR 'var/nrp'
hardcopy file are stored in directory var/nrp if automatic naming is activated.
SENS:SWE:HCOP:FILE:AUTO:DIR:CLE
deletes all hardcopy file that are stored in directory var/nrp.

Usage:

Event

Options:

Option R&S SMF-K28

SENSe[:POWer]:SWEep:HCOPy:FILE[:NAME]:AUTO:FILE?

This command query the file name that what generated using the automatic naming settings.

Note: As default the automatically generated file name is composed of: >Path>/<Prefix><YYYY><MM><DD><Number>.<Format>. Each component can be deactivated/activated separately to individually design the file name.

Return values:

<File> string

Example: SENS:SWE:HCOP:DEV:LANG BMP
 selects output format *.bmp.
 SENS:SWE:HCOP:FILE:AUTO:DIR 'var/nrp'
 hardcopy file are stored in directory var/nrp if automatic naming
 is activated.
 SENS:SWE:HCOP:FILE:AUTO:PREF 'sens1'
 the file name starts with the prefix sens1. The usage of automatic
 naming with prefix and date in the file name is preset (...:STAT
 ON).
 SENS:SWE:HCOP
 triggers the generation of a hardcopy of the current trace.
 SENS:SWE:HCOP:FILE:AUTO:FILE?
 queries the file name

Usage: Query only

Options: Option R&S SMF-K28

SENSe[:POWER]:SWEep:HCOPy:FILE[:NAME]:AUTO[:FILE]:DAY?

This command queries the day of the date part in the automatic file name.

Return values:

<Day> float

Example: SENS:SWE:HCOP:FILE:AUTO:DAY?
 queries the day of the date part in the automatic file name.

Usage: Query only

Options: Option R&S SMF-K28

SENSe[:POWER]:SWEep:HCOPy:FILE[:NAME]:AUTO[:FILE]:DAY:STATe <State>

This command activates the usage of the day in the automatic file name.

Parameters:

<State> 0 | 1 | OFF | ON
 *RST: ON

Example: SENS:SWE:HCOP:FILE:AUTO:DAY:STAT OFF
 deactivates the usage of the day in the automatic file name.

Options: Option R&S SMF-K28

SENSe[:POWER]:SWEep:HCOPy:FILE[:NAME]:AUTO[:FILE]:MONTH?

This command queries the day of the date part in the automatic file name.

Return values:

<Month> float

Example: SENS : SWE : HCOP : FILE : AUTO : MONT ?
queries the month of the date part in the automatic file name.

Usage: Query only

Options: Option R&S SMF-K28

SENSe[:POWER]:SWEep:HCOPy:FILE[:NAME]:AUTO[:FILE]:MONTH:STATe
<State>

This command activates the usage of the month in the automatic file name.

Parameters:
<State> 0 | 1 | OFF | ON
*RST: ON

Example: SENS : SWE : HCOP : FILE : AUTO : MONT : STAT OFF
deactivates the usage of the month in the automatic file name.

Options: Option R&S SMF-K28

SENSe[:POWER]:SWEep:HCOPy:FILE[:NAME]:AUTO[:FILE]:NUMBER?

This command queries the generated number in the automatic file name.

Return values:
<Number> float

Example: SENS : SWE : HCOP : FILE : AUTO : NUMB ?
queries the number in the automatic file name.

Usage: Query only

Options: Option R&S SMF-K28

SENSe[:POWER]:SWEep:HCOPy:FILE[:NAME]:AUTO[:FILE]:PREFIX <Prefix>

This command enters the prefix part in the automatic file name.

Parameters:
<Prefix> string

Example: SENS : SWE : HCOP : FILE : AUTO : PREF 'sensor'
the prefix sensor is used in the automatically generated file name
of the hardcopy file.

Options: Option R&S SMF-K28

SENSe[:POWER]:SWEep:HCOPy:FILE[:NAME]:AUTO[:FILE]:PREFIX:STATe
<State>

This command activates the usage of the prefix in the automatic file name.

Parameters:

<State> 0 | 1 | OFF | ON
 *RST: ON

Example:

SENS:SWE:HCOP:FILE:AUTO:STAT OFF
 deactivates the usage of the prefix in the automatic file name.

Options:

Option R&S SMF-K28

SENSe[:POWER]:SWEep:HCOPy:FILE[:NAME]:AUTO[:FILE]:YEAR?

This command queries the year of the date part in the automatic file name.

Return values:

<Year> float

Example:

SENS:SWE:HCOP:FILE:AUTO:YEAR?
 queries the year of the date part in the automatic file name.

Usage:

Query only

Options:

Option R&S SMF-K28

SENSe[:POWER]:SWEep:HCOPy:FILE[:NAME]:AUTO[:FILE]:YEAR:STATe <State>

This command activates the usage of the year in the automatic file name.

Parameters:

<State> 0 | 1 | OFF | ON
 *RST: ON

Example:

SENS:SWE:HCOP:FILE:AUTO:YEAR:STAT OFF
 deactivates the usage of the year in the automatic file name.

Options:

Option R&S SMF-K28

SENSe[:POWER]:SWEep:HCOPy:FILE[:NAME]:AUTO:STATe <State>

This command activates/deactivates automatic naming of the hardcopy files.

Parameters:

<State> 0 | 1 | OFF | ON
 *RST: ON

Example:

SENS:SWE:HCOP:FILE:AUTO:STAT OFF
 deactivates automatic naming of the hardcopy files. The file name and directory is now defined with command
 SENS:SWE:HCOP:FILE:NAME <path>.

Options:

Option R&S SMF-K28

:SENSe[:POWer]:SWEep:INITiate

This command starts the power analysis with NRP power sensor

Example: `SENS:SWE:INIT`
start the power measurement.

Usage: Setting only

Options: Option R&S SMF-K28

SENSe[:POWer]:SWEep:MODE <Mode>

This command selects power versus frequency measurement (frequency response), power vs power measurement (power sweep, AM/AM) or power vs. time measurement.

Parameters:
<Mode> `FREQuency | POWer | TIME`
*RST: `FREQuency`

Example: `SENS:SWE:MODE FREQ`
selects frequency mode.

Options: Option R&S SMF-K28

:SENSe[:POWer]:SWEep:POWer:REFerence:DATA:COpy

This command generates a reference curve for "Power" measurement.

Example: `SENS:POW:SWE:POW:REF:DATA:COpy`

Example: generates a reference curve in power mode.

Usage: Event

Options: R&S SMF-K28

:SENSe[:POWer]:SWEep:POWer:REFerence:DATA:POINts?

This command reads the number of points from the reference curve in "Power" measurement.

Return values:
<> float

Example: `SENS:POW:SWE:POW:REF:DATA:POIN?`

Example: queries the number of points from the reference curve in power mode.

Usage: Query only

Options: R&S SMF-K28

:SENSe[:POWer]:SWEep:POWer:REFerence:DATA:XVALues <Xvalues>

This command sets or queries the x values of the two reference points, i.e. "Power X (Point A)" and "Power X (Point B)" in "Power" measurement.

Parameters:

<Xvalues> string

Example: `SENSe:POW:SWE:POW:REF:DATA:XVAL -15DBM,20DBM`

Example: sets the x value of reference "Point A" to -15 dBm, and the value of "Point B" to 20 dBm.

Options: R&S SMF-K28

:SENSe[:POWer]:SWEep:POWer:REFerence:DATA:YVALues <Yvalues>

This command sets or queries the y values of the two reference points, i.e. "Power Y (Point A)" and "Power Y (Point B)" in "Power" measurement.

Parameters:

<Yvalues> string

Example: `SENSe:POW:SWE:TIME:REF:DATA:YVAL -30,10`

Example: sets the y value of reference "Point A" to -30 dBm, and the value of "Point B" to 10 dBm.

Options: R&S SMF-K28

SENSe[:POWer]:SWEep:POWer:RMODe <Rmode>

This command selects single or continuous mode for measurement mode power in power analysis.

Parameters:

<Rmode> SINGle | CONTInuous

*RST: SINGle

Example: `SENS:SWE:POW:RMOD SING`
selects single measurement

Options: Option R&S SMF-K28

:SENSe<ch>[:POWer]:SWEep:POWer[:SENSor]:OFFSet <Offset>

Defines the level offset at the sensor input in dB. Activate the offset with the command `:SENSe<ch>[:POWer]:SWEep:POWer[:SENSor]:OFFSet:STATe` on page 368.

Parameters:

<Offset> float

Range: -100 to 100

Increment: 0.01

*RST: 0

Example: `SENS2:SWE:POW:OFFS -5dB`
 defines a level offset of -5 dB.
`SENS2:SWE:POW:OFFS:STAT ON`
 activates that the specified level offset is taken into account.

Options: Option R&S SMF-K28

:SENSe<ch>[:POWer]:SWEep:POWer[:SENSor]:OFFSet:STATe <State>

Activates a level offset at the sensor input. Define the appropriate value with the command `:SENSe<ch>[:POWer]:SWEep:POWer[:SENSor]:OFFSet` on page 367.

Parameters:
 <State> 0 | 1 | OFF | ON
 *RST: 0

Example: `SENS2:SWE:POW:OFFS:STAT ON`
 activates the specified level offset.

Options: Option R&S SMF-K28

SENSe<ch>[:POWer]:SWEep:POWer[:SENSor]:SFRequency <Sfrequency>

This command defines the separate frequency used for power vs. power measurement.

Parameters:
 <Sfrequency> float
 *RST: 1 MHz

Example: `SENS1:SWE:POW:SENS:SFR 2GHz`
 'the measurement is performed at 2 GHz

SENSe<ch>[:POWer]:SWEep:POWer[:SENSor]:SFRequency:STATe <State>

This command activates the use of a different frequency for the power measurement.

Parameters:
 <State> 0 | 1 | OFF | ON
 *RST: OFF

Example: `SENS1:SWE:POW:SENS:SFR:STAT ON`
 activates the use of a separate frequency than the generator frequency for power analysis

:SENSe<ch>[:POWer]:SWEep:TIME[:SENSor]:OFFSet <Offset>

Defines the level offset at the sensor input in dB. Activate the offset with the command `:SENSe<ch>[:POWer]:SWEep:TIME[:SENSor]:OFFSet:STATe`.

Parameters:

<Offset> float
 Range: -100 to 100
 Increment: 0.01
 *RST: 0

Example:

SENS2:SWE:TIME:OFFS -7dB
 defines a level offset of -7 dB.
 SENS2:SWE:TIME:OFFS:STAT ON
 activates that the specified level offset is taken into account.

Options:

Option R&S SMF-K28

:SENSe<ch>[:POWer]:SWEep:TIME[:SENSor]:OFFSet:STATe <State>

Activates a level offset at the sensor input. Define the appropriate value with the command :SENSe<ch>[:POWer]:SWEep:TIME[:SENSor]:OFFSet.

Parameters:

<State> 0 | 1 | OFF | ON
 *RST: 0

Example:

SENS2:SWE:POW:TIME:STAT ON
 activates the specified level offset.

Options:

Option R&S SMF-K28

:SENSe<ch>[:POWer]:SWEep:TIME[:SENSor]:PULSe:STATe <State>

This command enables pulse data analysis. The measurement is started with command INITiate.

Note: The command are only available in time measurement mode and with R&S NRP-Z81 power sensors.

Parameters:

<State> 0 | 1 | OFF | ON
 *RST: OFF

Example:

SENS1:SWE:TIM:PULS:STAT ON
 enables pulse data analysis.

Options:

Option R&S SMF-K28

SENSe<ch>[:POWer]:SWEep:TIME[:SENSor]:PULSe:THReshold:BASE <Base>

This command selects how the threshold parameters for pulse analysis are calculated.

Note: The command is only available in time measurement mode and with R&S NRP-Z81 power sensors.

Parameters:

<Base> VOLTage | POWer
 *RST: VOLTage

Example:

SENS1 : SWE : TIME : PULS : THR : BASE POW
 activates threshold calculation related to power.

Options:

Option R&S SMF-K28

**:SENSe<ch>[:POWer]:SWEep:TIME[:SENSor]:PULSe:THReshold:POWer:
 HREFerence <HReference>**

This command sets the upper reference level in terms of percentage of the overall pulse level (power or voltage). The distal power defines the end of the rising edge and the start of the falling edge of the pulse.

Note: The command is only available in time measurement mode and with R&S NRP-Z81 power sensors.

Parameters:

<HReference> float
 Range: 0 to 100
 Increment: 0.01
 *RST: 90.0
 Default unit: %

Options:

Option R&S SMF-K28

**:SENSe<ch>[:POWer]:SWEep:TIME[:SENSor]:PULSe:THReshold:POWer:
 REFerence <Reference>**

Sets the medial reference level in terms of percentage of the overall pulse level (power or voltage related). This level is used to define pulse width and pulse period.

Note: The command is only available in time measurement mode and with R&S NRP-Z81 power sensors.

Parameters:

<Reference> float
 Range: 0.0 to 100.0
 Increment: 0.01
 *RST: 50.0
 Default unit: %

Example:

SENS1 : SWE : TIM : PULS : THR : REF 40
 sets the medial reference level to 40% of the overall pulse level.

Options:

Option R&S SMF-K28

**:SENSe<ch>[:POWer]:SWEep:TIME[:SENSor]:PULSe:THReshold:POWer:
LREFerence <LReference>**

This command sets the lower reference level in terms of percentage of the overall pulse level. The proximal power defines the start of the rising edge and the end of the falling edge of the pulse.

Note: This parameter is only available in time measurement mode and R&S NRP-Z81 power sensors.

Parameters:

<LReference> float
 Range: 0.0 to 100.0
 Increment: 0.01
 *RST: 10.0
 Default unit: %

Example: SENS:SWE:TIM:PULS:THR:LREF 10
 sets the lower reference level to 10%.

Options: Option R&S SMF-K28

SENSe[:POWer]:SWEep:POWer:SPACing[:MODE] <Mode>

This command queries the sweep spacing for the power versus power measurement. The setting is fixed to LINear.

Parameters:

<Mode> LINear
 *RST: LINear

Example: SENS:SWE:POW:SPAC?

Options: Option R&S SMF-K28

SENSe[:POWer]:SWEep:POWer:STARt <Start>

This command enters the start level for the power versus power measurement.

Parameters:

<Start> float
 *RST: -40 dBm

Example: SENS:SWE:POW:STAR -20.0DBM
 sets the start level to -20 dBm

Options: Option R&S SMF-K28

SENSe[:POWer]:SWEep:POWer:STEPs <Steps>

This command enters the number of measurement steps for the power versus power measurement.

Parameters:

<Steps> float
 Range: 10 to 1000
 *RST: 500

Example:

SENS:SWE:POW:STEP 500
 sets the 500 measurement steps

Options:

Option R&S SMF-K28

SENSe[:POWer]:SWEep:POWer:STOP <Stop>

This command enters the stop level for the power versus power measurement.

Parameters:

<Stop> float
 *RST: 30.0 dBm

Example:

SENS:SWE:POW:STOP 20.0DBM
 sets the stop level to 20 dBm

Options:

Option R&S SMF-K28

SENSe[:POWer]:SWEep:POWer:TIMing[:MODE] <Mode>

This command selects the timing mode of the measurement.

Parameters:

<Mode> FAST | NORMAl | HPRecision

FAST

Selection FAST leads to a fast measurement with a short integration times for each measurement step.

NORMAl

NORMAl leads to a longer but more precise measurement due to a higher integration time for each step.

*RST: NORMAl

Example:

SENS:SWE:POW:TIM:MODE FAST
 selects fast mode.

Options:

Option R&S SMF-K28

SENSe[:POWer]:SWEep:POWer:YScale:AUTO <Auto>

This command activates/deactivates autoscaling of the Y axis of the diagram.

Parameters:

<Auto>

OFF | CEXPanding | FEXPanding | CFLoating | FFLoating

OFF

Auto scaling is deactivated. When switching from activated to deactivated Auto scaling, the scaling is maintained. When switching from deactivated to activated Auto scaling, the scaling is reset to min = max = 0.

CEXPanding | FEXPanding

Auto scale is activated. The scaling of the Y-axis is selected in such a way, that the trace is always visible. To this end, the range is expanded if the minimum or maximum values of the trace move outside the current scale. The step width is 5 dB for selection course and variable in the range of 0.2 db to 5 dB for selection fine.

CFLoating | FFLoating

Auto scale is activated. The scaling of the Y-axis is selected in such a way, that the trace is always visible. To this end, the range is either expanded if the minimum or maximum values of the trace move outside the current scale or scaled down if the trace fits into a reduced scale. The step width is 5 dB for selection course and variable in the range of 0.2 db to 5 dB for selection fine.

*RST: OFF

Example:

SENS:SWE:POW:YSC:AUTO OFF

deactivates auto scale

Options:

Option R&S SMF-K28

SENSe[:POWER]:SWEep:POWer:YSCale:AUTO:RESet

This command resets the Y scale to suitable values after the use of auto scaling in the expanding mode. For this mode, the scale might get expanded because of temporarily high power values. The reset function allows resetting the diagram to match smaller power values again.

Example:

SENS:SWE:POW:YSC:AUTO:RES

resets auto scale

Usage:

Event

Options:

Option R&S SMF-K28

SENSe[:POWER]:SWEep:POWer:YSCale:MAXimum <Maximum>

This command enters the maximum value for the y axis of the measurement diagram.

Parameters:

<Maximum>

float

Range: min level to max level

*RST: 40 dBm

Example: `SENS:SWE:POW:YSC:MAX 10DBM`
sets 10 dBm as the upper limit of the measurement diagram.

Options: Option R&S SMF-K28

SENSe[:POWer]:SWEep:POWer:YSCale:MINimum <Minimum>

This command enters the minimum value for the y axis of the measurement diagram.

Parameters:

<Minimum> float
Range: min level to max level
*RST: -40 dBm

Example: `SENS:SWE:POW:YSC:MIN -10DBM`
sets -10 dBm as the lower limit of the measurement diagram.

Options: Option R&S SMF-K28

SENSe[:POWer]:SWEep:RMODE <Rmode>

This command selects single or continuous mode for power analysis (all measurement modes).

Parameters:

<Rmode> SINGLE | CONTInuous
*RST: SINGLE

Example: `SENS:SWE:RMODE SING`
selects single measurement

Options: Option R&S SMF-K28

SENSe[:POWer]:SWEep:TIME:RMODE <Rmode>

This command selects single or continuous mode for measurement mode time in power analysis.

Parameters:

<Rmode> SINGLE | CONTInuous
*RST: SINGLE

Example: `SENS:SWE:TIME:RMODE SING`
selects single measurement

Options: Option R&S SMF-K28

:SENSe[:POWer]:SWEep:TIME:AVERage[:COUNT] <Count>

This command selects the averaging factor in time mode. The count number determines how many measurement cycles are used to form a measurement result. Higher averaging counts reduce noise but increase the measurement time. Averaging requires a stable trigger event so that the measurement cycles have the same timing.

Parameters:

<Count> 1 | 2 | 4 | 8 | 16 | 32 | 64 | 128 | 256 | 512 | 1024
*RST: NORMal

Example:

```
SENS:SWE:MODE TIME
selects time mode
SENS:SWE:TIME:AVER 128
selects averaging factor 128
```

:SENSe[:POWer]:SWEep:TIME:REFerence:DATA:COPY

This command generates a reference curve for "Time" measurement.

Example: SENS:POW:SWE:TIME:REF:DATA:COPY

Example: generates a reference curve in time mode.

Usage: Event

Options: R&S SMF-K28

:SENSe[:POWer]:SWEep:TIME:REFerence:DATA:POINTs?

This command reads the number of points from the reference curve in "Time" measurement.

Return values:

<> float

Example: SENS:POW:SWE:TIME:REF:DATA:POIN?

Example: queries the number of points from the reference curve in time mode.

Usage: Query only

Options: R&S SMF-K28

:SENSe[:POWer]:SWEep:TIME:REFerence:DATA:XVALues <Xvalues>

This command sets or queries the x values of the two reference points, i.e. "Time X (Point A)" and "Time X (Point B)" in "Time" measurement.

Parameters:

<Xvalues> string

Example: SENSe:POW:SWE:TIME:REF:DATA:XVAL 5,45

Example: sets the x value of reference "Point A" to 5 μ s, and the value of "Point B" to 45 μ s.

Options: R&S SMF-K28

:SENSe[:POWer]:SWEep:TIME:REfERENCE:DATA:YVALues <Yvalues>

This command sets or queries the y values of the two reference points, i.e. "Power Y (Point A)" and "Power Y (Point B)" in "Time" measurement.

Parameters:

<Yvalues> string

Example: `SENSe:POW:SWE:TIME:REF:DATA:YVAL -30,10`

Example: sets the y value of reference "Point A" to -30 dBm, and the value of "Point B" to 10 dBm.

Options: R&S SMF-K28

SENSe<ch>[:POWer]:SWEep:TIME[:SENSor]:SFRequency <Sfrequency>

This command defines the separate frequency used for power vs. time measurement.

Parameters:

<Sfrequency> float
*RST: 1 MHz

Example: `SENS1:SWE:TIME:SENS:SFR 2GHz`
the measurement is performed at 2 GHz

Options: Option R&S SMF-K28

SENSe<ch>[:POWer]:SWEep:TIME[:SENSor]:SFRequency:STATe <State>

This command activates the use of a different frequency for the power measurement.

Parameters:

<State> 0 | 1 | OFF | ON
*RST: OFF

Example: `SENS1:SWE:TIME:SENS:SFR:STAT ON`
activates the use of a separate frequency than the generator frequency for power analysis

Options: Option R&S SMF-K28

SENSe<ch>[:POWer]:SWEep:TIME[:SENSor]:TRIGger:AUTO <Auto>

This command sets the trigger level, the hysteresis and the dropout time to default values.

Parameters:

<Auto> ONCE

Example: `SENS1:SWE:TIME:SENS:TRIG:AUTO ONCE`
the trigger level is automatically determined

Options: Option R&S SMF-K28

SENSe<ch>[:POWER]:SWEep:TIME[:SENSor]:TRIGger:DTIME <Dtime>

This command determines the minimum time for which the signal must be below (above) the power level defined by level and hysteresis before triggering can occur again.

Parameters:

<Dtime> float
Range: 0.0 to 10.0
*RST: 0
Default unit: s

Example: `SENS1:SWE:TIME:SENS:TRIG:DTIM 10 us`
the drop out time is 10 us

Options: Option R&S SMF-K28

SENSe<ch>[:POWER]:SWEep:TIME[:SENSor]:TRIGger:HYSTeresis <Hysteresis>

This command sets the hysteresis of the internal trigger threshold. Hysteresis is the magnitude (in dB) the trigger signal level must drop below the trigger threshold (positive trigger slope) before triggering can occur again.

Parameters:

<Hysteresis> float
Range: -10.0 to 10.0
*RST: 0.5
Default unit: dB

Example: `SENS1:SWE:TIME:SENS:TRIG:HYST 0.5 dB`
the hysteresis is 0.5 dB

Options: Option R&S SMF-K28

SENSe<ch>[:POWER]:SWEep:TIME[:SENSor]:TRIGger:LEVel <Level>

This command sets the trigger threshold.

Parameters:

<Level> float
Range: -200.0 to 100.0
*RST: 1
Default unit: dBm

Example: `SENS1:SWE:TIME:SENS:TRIG:LEV -20 dBm`
sets the trigger level to -20 dBm.

Options: Option R&S SMF-K28

:SENSe<ch>[:POWer]:SWEep:TIME[:SENSor]:TRIGger:SLOPe <TriggerSlope>

The command sets the polarity of the active slope for the trigger signals.

Parameters:

<TriggerSlope> POSitive | NEGative
 *RST: POSitive

Example:

SENS1:SWE:TIME:TRIG:SLOP POS
 the positive edge of a trigger signal is active.

Options:

Option R&S SMF-K28

SENSe<ch>[:POWer]:SWEep:TIME[:SENSor]:TRIGger:SOURce <Source>

This command selects if the measurement is free running (FREE) or starts only after a trigger event. The trigger can be applied internally or externally.

Parameters:

<Source> FREE | AUTO | INTernal | EXTernal
 *RST: AUTO

Example:

SENS1:SWE:TIME:SENS:TRIG:SOUR FREE
 the power versus time measurement is performed free running

Options:

Option R&S SMF-K28

SENSe[:POWer]:SWEep:TIME:SPACing[:MODE]?

This command queries the sweep spacing for the power versus time measurement. The spacing is fixed to linear.

Return values:

<Mode> LINear
 *RST: LINear

Example:

SENS:SWE:TIME:SPAC?
 queries the sweep spacing

Usage:

Query only

Options:

Option R&S SMF-K28

SENSe[:POWer]:SWEep:TIME:STARt <Start>

This command enters the start time for the power versus time measurement. Value 0 defines the trigger point. By choosing a negative time value, the trace can be shifted in the diagram. It is possible, that the measurement cannot be performed over the complete time range because of limitations due to sensor settings. In this case, an error message is output.

Parameters:

<Start> float
 Range: -1.0 to 1.0
 *RST: 0
 Default unit: s

Example:

SENS:SWE:TIME:STAR 0s
 sets the start time to 0 s

Options:

Option R&S SMF-K28

SENSe[:POWer]:SWEep:TIME:STEPs <Steps>

This command enters the number of measurement steps for the power versus time measurement. Value 0 defines the trigger point.

Parameters:

<Steps> float
 Range: 10 to 1000
 *RST: 200

Example:

SENS:SWE:TIME:STEP 500
 sets the 500 measurement steps

Options:

Option R&S SMF-K28

SENSe[:POWer]:SWEep:TIME:STOP <Stop>

This command enters the stop time for the power versus time measurement.

Parameters:

<Stop> float
 Range: 0.0 to 2.0
 *RST: 1.0ms
 Default unit: s

Example:

SENS:SWE:TIME:STOP 1ms
 sets the stop time to 1 ms

Options:

Option R&S SMF-K28

:SENSe[:POWer]:SWEep:TIME:TEVents <TriggerEvents>

This command determines, whether the measurement data processing starts with a trigger event in one of the sensors (Logical OR), or whether all channels have to be triggered (logical AND). Each sensor evaluates a trigger event according to its setting independently. This function supports the internal or external trigger modes with multi-channel time measurements.

Parameters:

<TriggerEvents> AND | OR
 *RST: AND

Example: `SENS:POW:SWE:TIME:TEV AND`
the measurement data processing starts when all channels are triggered.

Options: Option R&S SMF-K28

SENSe[:POWer]:SWEep:TIME:YSCale:AUTO <Auto>

This command activates/deactivates autoscaling of the Y axis of the diagram..

Parameters:

<Auto> OFF | CEXPanding | FEXPanding | CFLoating | FFLoating

OFF

Auto scaling is deactivated. When switching from activated to deactivated Auto scaling, the scaling is maintained. When switching from deactivated to activated Auto scaling, the scaling is reset to min = max = 0.

CEXPanding | FEXPanding

Auto scale is activated. The scaling of the Y-axis is selected in such a way, that the trace is always visible. To this end, the range is expanded if the minimum or maximum values of the trace move outside the current scale. The step width is 5 dB for selection course and variable in the range of 0.2 db to 5 dB for selection fine.

CFLoating | FFLoating

Auto scale is activated. The scaling of the Y-axis is selected in such a way, that the trace is always visible. To this end, the range is either expanded if the minimum or maximum values of the trace move outside the current scale or scaled down if the trace fits into a reduced scale. The step width is 5 dB for selection course and variable in the range of 0.2 db to 5 dB for selection fine.

*RST: OFF

Example: `SENS:SWE:TIME:YSC:AUTO OFF`
deactivates auto scale

Options: Option R&S SMF-K28

SENSe[:POWer]:SWEep:TIME:YSCale:AUTO:RESet

This command resets the Y scale to suitable values after the use of auto scaling in the expanding mode. For this mode, the scale might get expanded because of temporarily high power values. The reset function allows resetting the diagram to match smaller power values again.

Example: `SENS:SWE:TIME:YSC:AUTO:RES`
resets auto scale

Usage: Event

Options: Option R&S SMF-K28

SENSe[:POWer]:SWEep:TIME:YSCale:MAXimum <Maximum>

This command enters the maximum value for the y axis of the measurement diagram.

Parameters:

<Maximum> float
 Range: min level to max level
 *RST: 40
 Default unit: dBm

Example: SENS:SWE:TIME:YSC:MAX 10DBM
 sets 10 dBm as the upper limit of the measurement diagram.

Options: Option R&S SMF-K28

SENSe[:POWer]:SWEep:TIME:YSCale:MINimum <Minimum>

This command enters the minimum value for the y axis of the measurement diagram.

Parameters:

<Minimum> float
 Range: min level to max level
 *RST: -40
 Default unit: dBm

Example: SENS:SWE:TIME:YSC:MIN -10DBM
 sets -10 dBm as the lower limit of the measurement diagram.

Options: Option R&S SMF-K28

SENSe<ch>[:POWer]:TYPE?

The command queries the type of sensor. The type is automatically detected.

Return values:

<Type> string

Example: SENS:TYPE?
 queries the type of sensor connected to the POWER SENSOR connector.

Response: NRP-Z21
 the R&S NRP-Z21 sensor is used.

Usage: Query only

SENSe<ch>[:POWer]:ZERO

The command activates the autozero function. Zeroing is required in regular interval (at least once a day) and if the temperature has varied more than about 5 °C, if the sensor has been replaced or if measurements of signals with very low power are to be performed. The RF power source must be switched off or disconnected from the sensor before starting the autozero function.

Example: SENS : ZERO
 activates autozero function.

Usage: Event

SENSe<ch>:UNIT[:POWer] <Power>

The command selects the unit used for result query with command READ. The power sensor provides the measured value in Watt. In which unit the measured value is returned is selected here and might be either Watt, dBm or dBuV.

Parameters:

<Power> DBM | DBUV | WATT
*RST: DBM

Example: SENS2:UNIT DBM
 selects unit dBm for the measured value returned by command
 READ.
 READ2?
 Response: 7.34
 7.34 dBm are measured by sensor 2.

7.11.6 TRACe Subsystem

:TRACe<ch>[:POWer]:SWEep:COLor.....	383
:TRACe<ch>[:POWer]:SWEep:COpy.....	384
:TRACe<ch>[:POWer]:SWEep:DATA:POINts.....	384
:TRACe<ch>[:POWer]:SWEep:DATA:XVALues.....	384
:TRACe<ch>[:POWer]:SWEep:DATA:YVALues.....	385
:TRACe<ch>[:POWer]:SWEep:FEED.....	385
:TRACe[:POWer]:SWEep:MEASurement:FULLscreen:DISPlay:ANNotation[:STATe].....	386
:TRACe[:POWer]:SWEep:MEASurement:GATE:DISPlay:ANNotation[:STATe].....	386
:TRACe[:POWer]:SWEep:MEASurement:MARKer:DISPlay:ANNotation[:STATe].....	386
:TRACe<ch>[:POWer]:SWEep:MEASurement:POWer:AVERage.....	386
:TRACe<ch>[:POWer]:SWEep:MEASurement:POWer:HREFerence.....	386
:TRACe<ch>[:POWer]:SWEep:MEASurement:POWer:LREFerence.....	386
:TRACe<ch>[:POWer]:SWEep:MEASurement:POWer:MAXimum.....	386
:TRACe<ch>[:POWer]:SWEep:MEASurement:POWer:MINimum.....	386
:TRACe<ch>[:POWer]:SWEep:MEASurement:POWer:PULSe:BASE.....	386
:TRACe<ch>[:POWer]:SWEep:MEASurement:POWer:PULSe:TOP.....	386
:TRACe<ch>[:POWer]:SWEep:MEASurement:POWer:REFerence.....	387
:TRACe<ch>[:POWer]:SWEep:MEASurement:PULSe:DCYCle.....	387
:TRACe<ch>[:POWer]:SWEep:MEASurement:PULSe:DURation.....	387
:TRACe<ch>[:POWer]:SWEep:MEASurement:PULSe:PERiod.....	387
:TRACe<ch>[:POWer]:SWEep:MEASurement:PULSe:SEPARation.....	387
:TRACe<ch>[:POWer]:SWEep:MEASurement:PULSe:STATe.....	387
:TRACe<ch>[:POWer]:SWEep:MEASurement:TRANSition:NEGative:DURation.....	387
:TRACe<ch>[:POWer]:SWEep:MEASurement:TRANSition:NEGative:OCCurrence.....	387
:TRACe<ch>[:POWer]:SWEep:MEASurement:TRANSition:NEGative:OVERshoot.....	387
:TRACe<ch>[:POWer]:SWEep:MEASurement:TRANSition:POSitive:DURation.....	387

:TRACe<ch>[:POWer]:SWEep:MEASurement:TRANSition:POSitive:OCCurrence.....	387
:TRACe<ch>[:POWer]:SWEep:MEASurement:TRANSition:POSitive:OVERshoot.....	387
:TRACe[:POWer]:SWEep:MEASurement:PULSe:DISPlay:ANNotation[:STATe].....	387
:TRACe<ch>[:POWer]:SWEep:MEASurement:PULSe:ALL:DISPlay:ANNotation[:STATe].....	388
:TRACe[:POWer]:SWEep:MEASurement:STANdard:DISPlay:ANNotation[:STATe].....	388
:TRACe<ch>[:POWer]:SWEep:MEASurement:PULSe:DCYClE:DISPlay:ANNotation[: STATe].....	388
:TRACe<ch>[:POWer]:SWEep:MEASurement:PULSe:DURation:DISPlay:ANNotation[: STATe].....	388
:TRACe<ch>[:POWer]:SWEep:MEASurement:PULSe:PERiod:DISPlay:ANNotation[: STATe].....	388
:TRACe<ch>[:POWer]:SWEep:MEASurement:POWer:AVERage:DISPlay:ANNotation[: STATe].....	388
:TRACe<ch>[:POWer]:SWEep:MEASurement:POWer:PULSe:BASE:DISPlay: ANNotation[:STATe].....	388
:TRACe<ch>[:POWer]:SWEep:MEASurement:POWer:HREFerence:DISPlay: ANNotation[:STATe].....	388
:TRACe<ch>[:POWer]:SWEep:MEASurement:POWer:LREFerence:DISPlay: ANNotation[:STATe].....	388
:TRACe<ch>[:POWer]:SWEep:MEASurement:POWer:MAXimum:DISPlay:ANNotation[: STATe].....	388
:TRACe<ch>[:POWer]:SWEep:MEASurement:POWer:MINimum:DISPlay:ANNotation[: STATe].....	389
:TRACe<ch>[:POWer]:SWEep:MEASurement:POWer:REFerence:DISPlay: ANNotation[:STATe].....	389
:TRACe<ch>[:POWer]:SWEep:MEASurement:POWer:PULSe:TOP:DISPlay: ANNotation[:STATe].....	389
:TRACe<ch>[:POWer]:SWEep:MEASurement:PULSe:SEPARation:DISPlay: ANNotation[:STATe].....	389
:TRACe<ch>[:POWer]:SWEep:MEASurement:TRANSition:NEGative:DURation: DISPlay:ANNotation[:STATe].....	389
:TRACe<ch>[:POWer]:SWEep:MEASurement:TRANSition:NEGative:OCCurrence: DISPlay:ANNotation[:STATe].....	389
:TRACe<ch>[:POWer]:SWEep:MEASurement:TRANSition:NEGative:OVERshoot: DISPlay:ANNotation[:STATe].....	389
:TRACe<ch>[:POWer]:SWEep:MEASurement:TRANSition:POSitive:DURation:DISPlay: ANNotation[:STATe].....	389
:TRACe<ch>[:POWer]:SWEep:MEASurement:TRANSition:POSitive:OCCurrence: DISPlay:ANNotation[:STATe].....	389
:TRACe<ch>[:POWer]:SWEep:MEASurement:TRANSition:POSitive:OVERshoot: DISPlay:ANNotation[:STATe].....	389
:TRACe<ch>[:POWer]:SWEep:PULSe:THReshold:BASE.....	389
:TRACe<ch>[:POWer]:SWEep:PULSe:THReshold:POWer:HREFerence.....	390
:TRACe<ch>[:POWer]:SWEep:PULSe:THReshold:POWer:REFerence.....	390
:TRACe<ch>[:POWer]:SWEep:PULSe:THReshold:POWer:LREFerence.....	390
:TRACe<ch>[:POWer]:SWEep:STATe.....	391

:TRACe<ch>[:POWer]:SWEep:COLor <Color>

This command defines the color of each trace..

Parameters:

<Color> INVers | GRAY | YELLow | BLUE | GREen | RED | MAGenta
 *RST: trace 1 = YELLow, trace 2 = GREen, trace 3 = RED.

Example:

TRAC2:SWE:COL GRAY
 trace2 is indicated in gray color

:TRACe<ch>[:POWer]:SWEep:COpy <Copy>

This commands stores the selected trace data as reference trace.

Parameters:

<Copy> REFerence

Example:

TRAC2:SWE:COpy REF
 stores the current trace2 as reference trace'
 TRAC1:SWE:FEED REF
 assigns the reference trace to trace 1.

:TRACe<ch>[:POWer]:SWEep:DATA:POINts?

This commands queries the number of measurement points of the selected trace of the current power analysis.

Return values:

<Points> float

Example:

TRAC1:SWE:DATA:POIN?
 Response: 624
 Measurement trace 1 contains 624 measurement points

Usage:

Query only

:TRACe<ch>[:POWer]:SWEep:DATA:XVALues?

This commands queries the x-axis values - frequency, power or time values - of the selected trace of the current power analysis.

Return values:

<Xvalues> string

Example:

```
SENS:SWE:MODE FREQ
sets measurement mode frequency versus power.
SENS:SWE:RMOD SING
selects single measurement.
SENS:SWE:INIT
starts the measurement.
*OPC?
waits until measurement is performed.
TRAC1:SWE:DATA:XVAL?
queries the x-axis values of trace 1.
TRAC1:SWE:DATA:YVAL
queries the measurement values of trace 1.
```

Usage: Query only

:TRACe<ch>[:POWer]:SWEp:DATA:YVALues?

This commands queries the measurement (y-axis) values of the selected trace of the current power analysis.

Return values:

<Yvalues> string

Example:

```
SENS:SWE:TRAC2:DATA:YVAL?
queries the power values of trace 2.
```

Usage: Query only

:TRACe<ch>[:POWer]:SWEp:FEED <Feed>

This command selects the source for the trace data.

Parameters:

<Feed> SENSor1 | SENSor2 | SENSor3 | REFerence | NONE

*RST: The preset value for each trace is evaluated during runtime as follows: If a sensor is plugged into the generator whose number corresponds to the trace number, this sensor is used to feed the trace and the state of the trace is ON; If no sensor is found with number corresponding to the trace number, the preset value of the trace is "Off".

Example:

```
TRAC2:SWE:COPY REF
stores trace2 as reference trace.
TRAC1:SWE:FEED REF
assigns the reference trace to trace 1.
TRAC1:SWE:STAT ON
assigns the reference trace to trace 1.
SENS:SWE:RMOD SING
selects single measurement
SENS:SWE:INIT
starts the measurement
```

:TRACe[:POWer]:SWEep:MEASurement:FULLscreen:DISPlay:ANNOtation[:STATe] <State>

This command selects fullscreen display, only the diagram is displayed in the measurement diagram and in the hardcopy file.

Parameters:

<State> 0 | 1 | OFF | ON
 *RST: OFF

Example:

TRAC : SWE : MEAS : FULL : DISP : ANN ON
 the display only shows the diagram.

:TRACe[:POWer]:SWEep:MEASurement:GATE:DISPlay:ANNOtation[:STATe] <State>

This command selects if the time gate borders and values are indicated in the measurement diagram and in the hardcopy file. The gate settings are performed with the CALC : POW : SWE : TIME : GATE : ... commands.

Parameters:

<State> 0 | 1 | OFF | ON
 *RST: OFF

Example:

TRAC : SWE : MEAS : GATE : DISP : ANN ON
 the diagram also shows the gate information.

Options:

Option R&S SMF-K28

:TRACe[:POWer]:SWEep:MEASurement:MARKer:DISPlay:ANNOtation[:STATe] <State>

This command selects if the markers and the marker list are indicated in the measurement diagram and in the hardcopy file..

Parameters:

<State> 0 | 1 | OFF | ON
 *RST: OFF

Example:

TRAC : SWE : MEAS : MARK : DISP : ANN ON
 the diagram also shows the marker information.

Options:

Option R&S SMF-K28

:TRACe<ch>[:POWer]:SWEep:MEASurement:POWer:AVERage?
:TRACe<ch>[:POWer]:SWEep:MEASurement:POWer:HREFerence?
:TRACe<ch>[:POWer]:SWEep:MEASurement:POWer:LREFerence?
:TRACe<ch>[:POWer]:SWEep:MEASurement:POWer:MAXimum?
:TRACe<ch>[:POWer]:SWEep:MEASurement:POWer:MINimum?
:TRACe<ch>[:POWer]:SWEep:MEASurement:POWer:PULSe:BASE?
:TRACe<ch>[:POWer]:SWEep:MEASurement:POWer:PULSe:TOP?

```

:TRACe<ch>[:POWer]:SWEep:MEASurement:POWer:REFerence?
:TRACe<ch>[:POWer]:SWEep:MEASurement:PULSe:DCYCLe?
:TRACe<ch>[:POWer]:SWEep:MEASurement:PULSe:DURation?
:TRACe<ch>[:POWer]:SWEep:MEASurement:PULSe:PERiod?
:TRACe<ch>[:POWer]:SWEep:MEASurement:PULSe:SEParation?
:TRACe<ch>[:POWer]:SWEep:MEASurement:PULSe:STATe?
:TRACe<ch>[:POWer]:SWEep:MEASurement:TRANSition:NEGative:DURation?
:TRACe<ch>[:POWer]:SWEep:MEASurement:TRANSition:NEGative:
  OCCurrence?
:TRACe<ch>[:POWer]:SWEep:MEASurement:TRANSition:NEGative:OVERshoot?
:TRACe<ch>[:POWer]:SWEep:MEASurement:TRANSition:POSitive:DURation?
:TRACe<ch>[:POWer]:SWEep:MEASurement:TRANSition:POSitive:OCCurrence?
:TRACe<ch>[:POWer]:SWEep:MEASurement:TRANSition:POSitive:OVERshoot?

```

The listed commands query the measured pulse parameters values.

Note: These commands are only available in time measurement mode and with R&S NRP-Z81 power sensors.

Return values:

<Overshoot> float

Example:

```

TRAC1 : SWE : MEAS : POW : HREF ?
queries the measured mesial threshold level of trace 1
TRAC3 : SWE : MEAS : POW : MAX ?
queries the measured peak power of trace 3

```

Usage: Query only

Options: Option R&S SMF-K28

```

:TRACe[:POWer]:SWEep:MEASurement:PULSe:DISPlay:ANNotation[:STATe]
<State>

```

This command selects if the pulse data is shown below the measurement diagram and also stored in the hardcopy file. The parameters to be indicated can be selected with the following `TRAC : SWE : MEAS : ...` commands. Only six parameters are indicated at one time.

Note: This command is only available in time measurement mode and with R&S NRP-Z81 power sensors.

Parameters:

<State> 0 | 1 | OFF | ON
*RST: OFF

Example:

```

TRAC : SWE : MEAS : PULS : DISP : ANN ON
activates indication of the selected pulse data.

```

Options: Option R&S SMF-K28

```
:TRACe<ch>[:POWer]:SWEep:MEASurement:PULSe:ALL:DISPlay:ANNotation[:STATe] <State>
```

This command switches the indication of all pulse data of the selected trace off. The parameters to be indicated can be selected with the following `TRAC : SWE : MEAS : ...` commands. Only six parameters are indicated at one time.

Note: This command is only available in time measurement mode and with R&S NRP-Z81 power sensors.

Parameters:

```
<State>          0 | 1 | OFF | ON
                  *RST:      OFF
```

Example: `TRAC : SWE : MEAS : PULS : ALL : DISP : ANN OFF`
switches the indication of all pulse data off

Options: Option R&S SMF-K28

```
:TRACe[:POWer]:SWEep:MEASurement:STANdard:DISPlay:ANNotation[:STATe] <State>
```

This command selects the standard view, i.e. diagram and buttons but no lists are displayed and also stored in the hardcopy file.

Parameters:

```
<State>          0 | 1 | OFF | ON
                  *RST:      ON
```

Example: `TRAC : SWE : MEAS : STAN : DISP : ANN ON`
activates indication of the selected pulse data

Options: Option R&S SMF-K28

```
:TRACE<ch>[:POWer]:SWEep:MEASurement:PULSe:DCYClE:DISPlay:ANNotation[:STATe] <State>
:TRACE<ch>[:POWer]:SWEep:MEASurement:PULSe:DURation:DISPlay:ANNotation[:STATe] <State>
:TRACE<ch>[:POWer]:SWEep:MEASurement:PULSe:PERiod:DISPlay:ANNotation[:STATe] <State>
:TRACE<ch>[:POWer]:SWEep:MEASurement:POWer:AVERage:DISPlay:ANNotation[:STATe] <State>
:TRACE<ch>[:POWer]:SWEep:MEASurement:POWer:PULSe:BASE:DISPlay:ANNotation[:STATe] <State>
:TRACE<ch>[:POWer]:SWEep:MEASurement:POWer:HREFerence:DISPlay:ANNotation[:STATe] <State>
:TRACE<ch>[:POWer]:SWEep:MEASurement:POWer:LREFerence:DISPlay:ANNotation[:STATe] <State>
:TRACE<ch>[:POWer]:SWEep:MEASurement:POWer:MAXimum:DISPlay:ANNotation[:STATe] <State>
```

```

:TRACE<ch>[:POWer]:SWEep:MEASurement:POWer:MINimum:DISPlay:
  ANNotation[:STATe] <State>
:TRACE<ch>[:POWer]:SWEep:MEASurement:POWer:REFerence:DISPlay:
  ANNotation[:STATe] <State>
:TRACE<ch>[:POWer]:SWEep:MEASurement:POWer:PULSe:TOP:DISPlay:
  ANNotation[:STATe] <State>
:TRACE<ch>[:POWer]:SWEep:MEASurement:PULSe:SEParation:DISPlay:
  ANNotation[:STATe] <State>
:TRACE<ch>[:POWer]:SWEep:MEASurement:TRANSition:NEGative:DURation:
  DISPlay:ANNotation[:STATe] <State>
:TRACE<ch>[:POWer]:SWEep:MEASurement:TRANSition:NEGative:OCCurrence:
  DISPlay:ANNotation[:STATe] <State>
:TRACE<ch>[:POWer]:SWEep:MEASurement:TRANSition:NEGative:OVERshoot:
  DISPlay:ANNotation[:STATe] <State>
:TRACE<ch>[:POWer]:SWEep:MEASurement:TRANSition:POSitive:DURation:
  DISPlay:ANNotation[:STATe] <State>
:TRACE<ch>[:POWer]:SWEep:MEASurement:TRANSition:POSitive:OCCurrence:
  DISPlay:ANNotation[:STATe] <State>
:TRACE<ch>[:POWer]:SWEep:MEASurement:TRANSition:POSitive:OVERshoot:
  DISPlay:ANNotation[:STATe] <State>

```

The listed commands select the pulse parameters which are indicated in the display and hardcopy file. Only six parameters can be indicated at one time.

Note: These commands are only available in time measurement mode and with R&S NRP-Z81 power sensors.

Parameters:

<State> 0 | 1 | OFF | ON
 *RST: OFF

Example:

```

TRAC:SWE:MEAS:TRAC2:PULS:PER:DISP:ANN ON
selects the pulse period to be indicated in the display
TRAC:SWE:MEAS:PULS:DISP:ANN ON
activates indication of the selected pulse data in the display

```

Options:

Option R&S SMF-K28

:TRACe<ch>[:POWer]:SWEep:PULSe:THReshold:BASE?

This command queries how the threshold parameters are calculated.

Note: This parameter is only available in time measurement mode and R&S NRP-Z81 power sensors.

Return values:

<Base> VOLTage | POWer

Example:

```

TRAC1:SWE:PULS:THR:BAS?
queries the threshold base of pulse data calculation.

```

Usage:

Query only

:TRACe<ch>[:POWer]:SWEep:PULSe:THReshold:POWer:HREFerence?

This command queries the upper threshold level of the overall pulse level. The distal power defines the end of the rising edge and the start of the falling edge of the pulse.

Note: This parameter is only available in time measurement mode and R&S NRP-Z81 power sensors.

Return values:

<HReference> float
 Range: 0.0 to 100.0
 Increment: 0.01
 *RST: 90.0
 Default unit: %

Example: TRAC2 : SWE : PULS : THR : POW : HREF ?
 queries the upper reference level of trace 2.

Usage: Query only

:TRACe<ch>[:POWer]:SWEep:PULSe:THReshold:POWer:REFerence?

This command queries the medial threshold level of the overall pulse level. This level is used to define the pulse width and pulse period.

Note: This parameter is only available in time measurement mode and R&S NRP-Z81 power sensors.

Return values:

<Reference> float
 Range: 0.0 to 100.0
 Increment: 0.01
 *RST: 50.0
 Default unit: %

Example: TRAC3 : SWE : PULS : THR : POW : REF ?
 queries the medial threshold level of trace 3.

Usage: Query only

:TRACe<ch>[:POWer]:SWEep:PULSe:THReshold:POWer:LREFerence?

This command queries the lower medial threshold level of the overall pulse level. The proximal power defines the start of the rising edge and the end of the falling edge of the pulse.

Note: This parameter is only available in time measurement mode and R&S NRP-Z81 power sensors.

Return values:

<LReference> float
 Range: 0.0 to 100.0
 Increment: 0.01
 *RST: 10.0
 Default unit: %

Example:

TRAC : SWE : PULS : THR : POW : LREF?
 queries the medial threshold level of trace 1.

Usage:

Query only

:TRACe<ch>[:POWer]:SWEep:STATe <State>

This command activates the selected trace.

Parameters:

<State> OFF | ON | HOLD
 *RST: The preset value for each trace is evaluated during runtime as follows: If a sensor is plugged into the generator whose number corresponds to the trace number, this sensor is used to feed the trace and the state of the trace is ON; If no sensor is found with a number corresponding to the trace number, the preset value of the trace is "Off".

Example:

TRAC2 : SWE : COPY REF
 stores trace2 as reference trace'
 TRAC1 : SWE : FEED REF
 assigns the reference trace to trace 1.
 TRAC1 : SWE : STAT ON
 assigns the reference trace to trace 1.
 SENS : SWE : RMOD SING
 selects single measurement
 SENS : SWE : INIT
 starts the measurement

7.12 SOURce Subsystem

The SOURce subsystem contains the commands for configuring the digital and analog signals.

SOURce<hw>

For one-path instruments, the keyword SOURce is optional and can be omitted.

- [SOURce:AM Subsystem](#).....392
- [SOURce:CHIRp Subsystem](#).....394
- [SOURce:CORRection Subsystem](#).....398
- [SOURce:DM Subsystem](#).....407

• SOURce:FM Subsystem.....	410
• SOURce:FREQuency Subsystem.....	412
• SOURce:INPut Subsystem.....	419
• SOURce:LFOuTput Subsystem.....	420
• SOURce:LIST Subsystem.....	441
• SOURce:MODulation Subsystem.....	455
• SOURce:NOISe Subsystem.....	455
• SOURce:PGEN Subsystem.....	456
• SOURce:PHASe Subsystem.....	457
• SOURce:PM Subsystem.....	458
• SOURce:POWer Subsystem.....	460
• SOURce:PULM Subsystem.....	469
• SOURce:ROSCillator Subsystem.....	484
• SOURce:SWEep Subsystem.....	487

7.12.1 SOURce:AM Subsystem

The AM subsystem contains the commands for checking the amplitude modulation.

The settings for the internal modulation source (LF generator) are made in the SOURce:LFOuTput subsystem.

The external signal is input at the EXT1 and/or EXT2 connector.

[SOURce<hw>]:AM<ch>[:DEPT].....	392
[SOURce<hw>]:AM:RATio.....	392
[SOURce<hw>]:AM:SCAN:STATe.....	393
[SOURce<hw>]:AM<ch>:SENSitivity.....	393
[SOURce<hw>]:AM<ch>:SOURce.....	393
[SOURce<hw>]:AM<ch>:STATe.....	394

[SOURce<hw>]:AM<ch>[:DEPT] <Depth>

The command sets the overall modulation depth of the amplitude modulation in percent.

Parameters:

<Depth>	float
	Range: 0 to 100
	*RST: 30 PCT

Example:

```
AM1:DEPT 15PCT
sets the AM modulation depth to 15 percent for path 1.
```

Options:

R&S SMF-B20

[SOURce<hw>]:AM:RATio <Ratio>

The command sets the overall modulation depth of the amplitude modulation in percent.

Parameters:

<Ratio> float
 Range: 0 to 100
 *RST: 100

Example:

AM:RAT 50PCT
 sets the path 1/path 2 ratio to 50 percent.

Options:

R&S SMF-B20

[:SOURce<hw>]:AM:SCAN:STATe <State>

The command activates/deactivates logarithmic amplitude modulation.

Parameters:

<State> OFF | ON
 *RST: OFF

Example:

AM:SCAN:STAT ON
 activates the logarithmic amplitude modulation.

Options:

R&S SMF-B20

[:SOURce<hw>]:AM<ch>:SENSitivity <Sensitivity>

The command sets the input sensitivity of the EXT input in dB/V.

The command is available for scan state ON only.

Parameters:

<Sensitivity> float
 Range: -10 dB/V to 10 dB/V
 *RST: 1

Example:

AM1:SENS 5
 sets the input sensitivity to 5 dB/V for path 1.

Options:

R&S SMF-B20

[:SOURce<hw>]:AM<ch>:SOURce <Source>

The command selects the modulation source for amplitude modulation. The external signal is input at the EXT1 and/or EXT2 connector. Internal and external modulation source can be selected at the same time.

Parameters:

<Source> LF1 | LF2 | NOISe | EXT1 | EXT2
 *RST: EXT1

Example:

AM1:SOUR LF1
 selects the LF generator 1 as internal modulation source for path 1.

Options: R&S SMF-B20

[:SOURce<hw>]:AM<ch>:STATe <State>

The command activates/deactivates amplitude modulation.

Parameters:

<State> 0 | 1 | OFF | ON
 *RST: 0

Example: AM:STAT ON
 activates AM modulation.

7.12.2 SOURce:CHIRp Subsystem

The SOURce:CHIRp subsystem contains the commands for setting the modulation chirp.

The keyword SOURce is optional with commands and can be omitted.

[:SOURce<hw>]:CHIRp:BANDwidth.....	394
[:SOURce<hw>]:CHIRp:COMPression:RATio.....	395
[:SOURce<hw>]:CHIRp:DIRection.....	395
[:SOURce<hw>]:CHIRp:PULSe:PERiod.....	395
[:SOURce<hw>]:CHIRp:PULSe:WIDTh.....	395
[:SOURce<hw>]:CHIRp:STATe.....	396
[:SOURce<hw>]:CHIRp:TRIGger:EXTernal:GATE:POLarity.....	396
[:SOURce<hw>]:CHIRp:TRIGger:EXTernal:IMPedance.....	396
[:SOURce<hw>]:CHIRp:TRIGger:EXTernal:LEVel.....	397
[:SOURce<hw>]:CHIRp:TRIGger:EXTernal:SLOPe.....	397
[:SOURce<hw>]:CHIRp:TRIGger:MODE.....	397

[:SOURce<hw>]:CHIRp:BANDwidth <Bandwidth>

The command sets the modulation bandwidth of the modulation chirp in Hz. The maximal bandwidth depends on the RF frequency set and the selected modulation mode (see data sheet).

Parameters:

<Bandwidth> float
 Range: 0 Hz to 80 MHz
 Increment: See data sheet
 *RST: 1 kHz
 Default unit: Hz

Example: CHIR:BAND 5E3
 sets the modulation bandwidth to 5 kHz.

Options: R&S SMF-B20, R&S SMF-K3, and R&S SMF-K23

[[:SOURce<hw>]:CHIRp:COMPression:RATio?

The command queries the pulse compression ratio, i.e. the product of pulse width (s) and bandwidth (Hz). Pulse compression increases the range resolution as well as the signal to noise ratio of pulsed signals.

Return values:

<Ratio> float
Increment: 0.01

Example: CHIR:COMP:RAT?
'queries the compression ratio.

Usage: Query only

Options: R&S SMF-B20, R&S SMF-K3, and R&S SMF-K23

[[:SOURce<hw>]:CHIRp:DIRection <Direction>

Selects the direction of the chirp modulation.

Parameters:

<Direction> DOWN | UP
UP
The chirp starts with the lower frequency.
DOWN
The chirp starts with the higher frequency.
*RST: UP

Example: SOUR:CHIR:DIR UP

[[:SOURce<hw>]:CHIRp:PULSe:PERiod <Period>

The command sets the period of the generated modulation chirp. The period determines the repetition frequency of the internal signal.

Parameters:

<Period> float
Range: 200 ns to 100s
Increment: 200 ns
*RST: 10.000 ns
Default unit: s

Example: CHIR:PULS:PER 420 ns
the chirp period is 420 ns.

Options: R&S SMF-B20, R&S SMF-K3, and R&S SMF-K23

[[:SOURce<hw>]:CHIRp:PULSe:WIDTh <Width>

The command sets the width of the generated pulse. The pulse width must be at least 1us less than the set pulse period.

Parameters:

<Width> float
 Range: 100 ns to 100 s
 Increment: 100 ns
 *RST: 1000 ns
 Default unit: s

Example:

CHIR:PULS:WIDT 330 ns
 sets a width of 330 ns for the pulse.

Options:

R&S SMF-B20, R&S SMF-K3, and R&S SMF-K23

[[:SOURce<hw>]:CHIRp:STATe <State>

The command activates/deactivates the generation of modulation chirps.

Parameters:

<State> 0 | 1 | OFF | ON
 *RST: OFF

Example:

CHIR:STAT ON
 activates generation of modulation chirps.

Options:

R&S SMF-B20, R&S SMF-K3, and R&S SMF-K23

[[:SOURce<hw>]:CHIRp:TRIGger:EXTernal:GATE:POLarity <Polarity>

The command selects the active level of the gate signal.

Parameters:

<Polarity> NORMal | INVerted

NORMal

The chirp modulation signals are generated while the gate signal is high.

INVerted

The chirp modulation signals are generated while the gate signal is low.

*RST: NORMal

Example:

CHIR:TRIG:EXT:GATE:POL NORM
 selects gate polarity normal.

Options:

R&S SMF-B20, R&S SMF-K3, and R&S SMF-K23

[[:SOURce<hw>]:CHIRp:TRIGger:EXTernal:IMPedance <Impedance>

The commands set the impedance for external feed via the PULSE EXT input.

Parameters:

<Impedance> G10k | G50
G10k
 10 kOhm to ground
G50
 50 ohm to ground
 *RST: G50

Example:

CHIR:TRIG:EXT:IMP G10K
 the PULSE IN input is set to 10 kOhm to ground.

Options:

R&S SMF-B20, R&S SMF-K3, and R&S SMF-K23

[[:SOURce<hw>]:CHIRp:TRIGger:EXTernal:LEVel <Level>

The command selects the external trigger level.

Parameters:

<Level> TTL | M2V5 | P0V5
TTL
 trigger level is threshold TTL.
P0V5
 trigger level is 0.5 V.
M2V5
 trigger level is -2.5 V.
 *RST: TTL

Example:

CHIRp:TRIG:EXT:LEV TTL
 selects threshold TTL as external trigger level.

Options:

R&S SMF-B20, R&S SMF-K3, and R&S SMF-K23

[[:SOURce<hw>]:CHIRp:TRIGger:EXTernal:SLOPe <Slope>

The command sets the active slope of an externally applied trigger signal.

The signal is supplied via the PULSE IN connector.

Parameters:

<Slope> NEGative | POSitive
 *RST: POSitive

Example:

CHIR:TRIG:EXT:SLOP
 the active slope of the external trigger signal is the falling slope.

Options:

R&S SMF-B20, R&S SMF-K3, and R&S SMF-K23

[[:SOURce<hw>]:CHIRp:TRIGger:MODE <Mode>

The command selects the trigger mode for modulation chirp.

Note: External trigger signals are supplied via the PULSE IN connector.

Parameters:

<Mode> AUTO | EXTeRnal | EGATe

AUTO

The modulation chirp is generated continuously.

EXTeRnal

The modulation chirp is triggered by an external trigger event.

EGATe

The modulation chirp is gated by an external gate signal.

*RST: AUTO

Example:

CHIR:TRIG:EXT:MODE EXT

selects triggering by an external trigger event.

Options:

R&S SMF-B20, R&S SMF-K3, and R&S SMF-K23

7.12.3 SOURce:CORRection Subsystem

The output level is corrected in the CORRection subsystem. Correction is performed by user-defined table values being added to the output level for the respective RF frequency. In the R&S SMF, this subsystem is used to select, transfer and activate user correction tables.

Each list is stored as a file. The name of the user correction file can be freely selected. The file extension *.uco is assigned automatically and cannot be changed.

The files can be stored in a freely selectable directory and opened from there. The default directory is set using command :MMEMory:CDIRectory on page 328. In the case of files which are stored in the default directory, only the file name has to be specified in commands. Otherwise, the complete absolute path has to be specified with every command. The extension can be omitted in any case.



In the following command examples, the files are stored in the default directory.

The amplitude can also be linearized automatically by means of a R&S NRP power sensor connected to the generator output signal. With the aid of the command [:SOURce<hw>]:CORRection:CSET:DATA[:SENSor<ch>][:POWer]:SONCe, a list with correction values for external test assemblies can be automatically determined, e.g. for compensating the frequency response of cables. The correction values can be acquired any time irrespective of the modulation settings of the generator.

```
[:SOURce]:CORRection:CSET:CATalog.....399
[:SOURce<hw>]:CORRection:CSET:DATA:FREQUency.....399
[:SOURce<hw>]:CORRection:CSET:DATA:FREQUency:POINts.....400
[:SOURce<hw>]:CORRection:CSET:DATA:POWer.....400
[:SOURce<hw>]:CORRection:CSET:DATA:POWer:POINts.....400
[:SOURce<hw>]:CORRection:CSET:DATA[:SENSor<ch>][:POWer]:SONCe.....401
```

<code>[:SOURce]:CORRection:CSET:DELeTe</code>	401
<code>[:SOURce<hw>]:CORRection:DEXChange:AFILe:CATalog</code>	401
<code>[:SOURce<hw>]:CORRection:DEXChange:AFILe:EXTension</code>	402
<code>[:SOURce<hw>]:CORRection:DEXChange:AFILe:SELeCt</code>	402
<code>[:SOURce<hw>]:CORRection:DEXChange:AFILe:SEParator:COLumn</code>	403
<code>[:SOURce<hw>]:CORRection:DEXChange:AFILe:SEParator:DECimal</code>	403
<code>[:SOURce<hw>]:CORRection:DEXChange:EXECute</code>	404
<code>[:SOURce<hw>]:CORRection:DEXChange:MODE</code>	404
<code>[:SOURce<hw>]:CORRection:DEXChange:SELeCt</code>	405
<code>[:SOURce<hw>]:CORRection:CSET[:SELeCt]</code>	405
<code>[:SOURce<hw>]:CORRection:MEASure</code>	406
<code>[:SOURce<hw>]:CORRection:PMETer:TYPE</code>	406
<code>[:SOURce<hw>]:CORRection[:STATe]</code>	406
<code>[:SOURce<hw>]:CORRection:VALue</code>	406

`[:SOURce]:CORRection:CSET:CATalog?`

The command requests a list of user correction tables. The individual lists are separated by commas.

The lists are stored with the fixed file extensions * .ucor in a directory of the user's choice. The directory applicable to the commands is defined with the command `MMEMoRY:CDIR`.

Return values:

<Catalog> string

Example:

```
MMEM:CDIR '/var//Lists/ucor'
```

selects the directory for the user correction files.

```
CORR:CSET:CAT?
```

queries which correction tables are available.

```
Response:UCOR1,UCOR2,UCOR3
```

the correction tables UCOR1, UCOR2 and UCOR3 are available.

Usage: Query only

`[:SOURce<hw>]:CORRection:CSET:DATA:FREQuency <Frequency>`

The command transfers the frequency data to the table selected with `:CORRection:CSET:SELeCt`.

The numerical suffix at SOURce must not be used for this command.

Parameters:

<Frequency> Frequency#1[, Frequency#2, ...]
 Range: 300 kHz to RFmax (depending on model)
 Default unit: Hz

Example:

```
CORR:CSET '/var//Lists/ucor/ucor1'
```

selects the table ucor1.

```
CORR:CSET:DATA:FREQ 100MHz,102MHz,103MHz,...
```

enters the frequency value in the table ucor1.

[[:SOURce<hw>]:CORRection:CSET:DATA:FREQuency:POINts?

The command queries the number of frequency values in the selected table.

The numerical suffix at SOURce must not be used for this command.

Return values:

<Points> float

Example:

```
CORR:CSET '/var//Lists/ucor/ucor1'
selects the table ucor1.
CORR:CSET:DATA:FREQ:POIN?
queries the number of frequency values in the table ucor1.
Response: 440
the table ucor1 contains 440 frequency values.
```

Usage: Query only

[[:SOURce<hw>]:CORRection:CSET:DATA:POWer <Power>

The command transfers the level data to the table selected

with :CORRection:CSET:SELEct.

*RST does not affect data lists. The numerical suffix at SOURce must not be used for this command.

Parameters:

<Power> Power#1[, Power#2, ...]
 Range: -40 dB to 6 dB
 Default unit: dB

Example:

```
CORR:CSET '/var//Lists/ucor/ucor1'
selects the table ucor1.
CORR:CSET:DATA:POW 1dB, 0.8dB, 0.75dB,...
enters the level values in the table ucor1.
```

[[:SOURce<hw>]:CORRection:CSET:DATA:POWer:POINts?

The command queries the number of level values in the selected table.

The numerical suffix at SOURce must not be used for this command.

Return values:

<Points> float

Example:

```
CORR:CSET '/var//Lists/ucor/ucor1'
selects the table ucor1.
CORR:CSET:DATA:POW:POIN?
queries the number of level values in the table ucor1.
Response: 440
the table ucor1 contains 440 level values.
```

Usage: Query only

[[:SOURce<hw>]:CORRection:CSET:DATA[:SENSor<ch>]][:POWER]:SONCe

The command fills the selected user correction list with the level values measured by the power sensor for the given frequencies.

The power sensor used is selected by the suffix in key word `SENSe` of the command header.

Suffix:`<ch>`

1 .. 3

Suffix 1 denotes the sensor connected to the SENSOR connector, suffix 2 the sensor connected first to one of the USB interfaces and suffix 3 the sensor connected second to one of the USB interfaces.

Example:

```
CORR:CSET:DATA:SENS:POW:SONC
```

fills the user correction list with level values acquired by the power sensor connector to the SENSOR connector.

Usage:

Event

[[:SOURce]:CORRection:CSET:DELeTe <Delete>

The command deletes the specified table.

The lists are stored with the fixed file extensions `*.uco` in a directory of the user's choice. The directory applicable to the commands is defined with the command `MMEMoRY:CDIR`. A path can also be specified in command `:SOUR:CORR:CSET:CAT?`, in which case the file in the specified directory is deleted.

The numerical suffix under `SOURce` is irrelevant.

Setting parameters:

`<Delete>` `<table name>`

Example:

```
MMEM:CDIR '/var//Lists/ucor'
```

selects the directory for the user correction files.

```
CORR:CSET:DEL 'UCOR1'
```

deletes the table `ucor1`.

Usage:

Event

[[:SOURce<hw>]:CORRection:DEXChange:AFILe:CATalog?

The command requests a list of available ASCII files for export/import of user correction data. The individual files are separated by commas.

The ASCII files are stored with the fixed file extensions `*.txt` or `*.csv` in a directory of the user's choice. The directory applicable to the commands is defined with the command `MMEMoRY:CDIR`.

Return values:`<Catalog>`

string

Example: `MMEM:CDIR '/var//lists/ucor/import'`
 selects the directory for the ASCII files with frequency and level value pairs.
`CORR:DEXC:AFIL:EXT TXT`
 selects that ASCII files with extension `*.txt` are listed.
`CORR:DEXC:AFIL:CAT?`
 queries the available files with extension `*.txt`.
 Response: `'ucor1,ucor2'`
 the ASCII files `ucor1.txt` and `ucor2.txt` are available.

Usage: Query only

[:SOURce<hw>]:CORRection:DEXChange:AFILe:EXTension <Extension>

The command selects the file extension of the ASCII file to be imported or exported. Selection TXT (text file) or CSV (Excel file) is available.

Parameters:

<Extension> TXT | CSV
 *RST: TXT

Example: `MMEM:CDIR '/var//lists/ucor/import'`
 selects the directory for the ASCII files with frequency and level value pairs.
`CORR:DEXC:AFIL:EXT TXT`
 selects that ASCII files with extension `*.txt` are listed.
`CORR:DEXC:AFIL:CAT?`
 queries the available files with extension `*.txt`.
 Response: `'list1,list2'`
 the ASCII files `ucor1.txt` and `ucor2.txt` are available.

[:SOURce<hw>]:CORRection:DEXChange:AFILe:SELEct <Select>

The command selects the ASCII file to be imported or exported.

The ASCII files are stored with the fixed file extensions `*.txt` or `*.csv` in a directory of the user's choice. The directory applicable to the commands is defined with the command `MMEMoRY:CDIR`. A path can also be specified in command `SOUR:CORR:DEXC:AFIL:SEL`, in which case the files are stored or loaded in the specified directory.

Parameters:

<Select> <ascii file name>

Example:

```
CORR:DEXC:MODE IMP
```

selects that ASCII files with frequency and level value pairs are imported and transferred into user correction lists.

```
CORR:DEXC:AFIL:SEL
```

```
'/var//user/ucor/import/ucor.csv'
```

selects that ASCII file ucor.csv is imported.

```
CORR:DEXC:SEL '/var//user/ucor/import/ucor_imp'
```

selects that the ASCII file ucor.csv is imported into user correction list ucor_imp.

[[:SOURce<hw>]:CORRection:DEXChange:AFILe:SEParator:COLumn <Column>

The command selects the separator between the frequency and level column of the ASCII table.

Parameters:

<Column>

TABulator | SEMicolon | COMMa | SPACe

*RST: SEMicolon|

Example:

```
CORR:DEXC:MODE EXP
```

selects that the user correction list is exported into an ASCII file.

```
CORR:DEXC:AFIL:SEL
```

```
'/var//user/ucor/import/ucor.csv'
```

selects ASCII file ucor.csv as destination for the user correction list data.

```
CORR:DEXC:AFIL:SEP:COL TAB
```

the pairs of frequency and level values are separated by a tabulator.

```
CORR:DEXC:AFIL:SEP:DEC DOT
```

selects the decimal separator dot.

```
CORR:DEXC:SEL '/var//user/ucor/import/ucor_imp'
```

selects that the user correction list ucor_imp is imported into ASCII file ucor.csv.

[[:SOURce<hw>]:CORRection:DEXChange:AFILe:SEParator:DECimal <Decimal>

The command the decimal separator used in the ASCII data between '.' (decimal point) and ',' (comma) with floating-point numerals.

Parameters:

<Decimal>

DOT | COMMa

*RST: DOT

Example:

```
CORR:DEXC:MODE EXP
selects that the user correction list is exported into an ASCII file.
CORR:DEXC:AFIL:SEL
'/var//user/ucor/import/ucor.csv'
selects ASCII file ucor.csv as destination for the user correction
list data.
CORR:DEXC:AFIL:SEP:COL TAB
the pairs of frequency and level values are separated by a tabu-
lator.
CORR:DEXC:AFIL:SEP:DEC DOT
selects the decimal separator dot.
CORR:DEXC:SEL '/var//user/ucor/import/ucor_imp'
selects that the user correction list ucor_imp is imported into ASCII
file ucor.csv.
```

[:SOURce<hw>]:CORRection:DEXChange:EXECute

The command starts the export or import of the selected file. When import is selected, the ASCII file is imported as user correction list. When export is selected, the user correction list is exported into the selected ASCII file.

Example:

```
CORR:DEXC:MODE IMP
selects that ASCII files with frequency and level value pairs are
imported and transferred into user correction lists.
CORR:DEXC:AFIL:SEL
'/var//user/ucor/import/ucor.csv'
selects that ASCII file ucor.csv is imported.
CORR:DEXC:SEL '/var//user/ucor/import/ucor_imp'
selects that the ASCII file ucor.csv is imported into user correction
list ucor_imp.
CORR:DEXC:EXEC
starts the import of the ASCII file data into the user correction file.
```

Usage: Event

[:SOURce<hw>]:CORRection:DEXChange:MODE <Mode>

The command selects if user correction lists should be imported or exported. Depending on the selection her, the file select command define either the source or the destination for user correction lists and ASCII files.

Parameters:

<Mode> IMPort | EXPort
 *RST: IMPort

Example:

```
CORR:DEXC:MODE IMP
selects that ASCII files with frequency and level value pairs are
imported and transferred into user correction lists.
CORR:DEXC:AFIL:SEL
'/var//user/ucor/import/ucor.csv'
selects that ASCII file ucor.csv is imported.
CORR:DEXC:SEL '/var//user/ucor/import/ucor_imp'
selects that the ASCII file ucor.csv is imported into user correction
list ucor_imp.
```

[:SOURce<hw>]:CORRection:DEXChange:SElect <Select>

The command selects the user correction list to be imported or exported.

The user correction files are stored with the fixed file extensions *.uco in a directory of the user's choice. The directory applicable to the commands is defined with the command MMEMoRY:CDIR. A path can also be specified in command SOUR:CORR:DEXC:SEL, in which case the files are stored or loaded in the specified directory.

Parameters:

<Select> <list name>

Example:

```
CORR:DEXC:MODE IMP
selects that ASCII files with frequency and level value pairs are
imported and transferred into user correction lists.
CORR:DEXC:AFIL:SEL
'/var//user/ucor/import/ucor.csv'
selects that ASCII file ucor.csv is imported.
CORR:DEXC:SEL '/var//user/ucor/import/ucor_imp'
selects that the ASCII file ucor.csv is imported into user correc-
tion list ucor_imp.
```

[:SOURce<hw>]:CORRection:CSET[:SElect] <Select>

The command selects the table for user correction. Level correction must also be activated with the command SOURce<hw>:CORRection:CSET:STATe ON.

The lists are stored with the fixed file extensions *.uco in a directory of the user's choice. The directory applicable to the commands is defined with the command MMEMoRY:CDIR. A path can also be specified in command :SOUR:CORR:CSET:SEL, in which case the files in the specified directory are selected.

Parameters:

<Select> <table name>

Example:

```
CORR:CSET '/var//Lists/ucor/ucor1'
selects the table ucor1.
CORR ON
activates level correction. Correction is performed using the table
ucor1.
```

Usage: Event

[:SOURce<hw>]:CORRection:MEASure <Measure>

The command triggers the external measurement of the user correction of the level according to the user defined frequencies.

Example: SOUR:CORR:MEAS
 triggers the external measurement of the user correction of the level according to the user defined frequencies.

[:SOURce<hw>]:CORRection:PMETer:TYPE <Type>

The command selects the power meter used for user correction.

Parameters:
<Type> NRP | NRVD | HP437 | ML2438 | P44X
 *RST: NRP

Example: SOUR:CORR:PMET:TYPE NRVD
 the specified power meter is used for user correction.

[:SOURce<hw>]:CORRection[:STATe] <State>

The command activates/deactivates level correction. Level correction is performed using the table which has been selected with the command `CORRection:CSET:SElect`.

Parameters:
<State> 0 | 1 | OFF | ON
 *RST: OFF

Example: SOUR:CORR:CSET '/var//lists/ucor/ucor1'
 selects the table `ucor1`.
 SOUR:CORR ON
 activates user correction.

[:SOURce<hw>]:CORRection:VALue?

The command requests the current value for user correction.

Return values:
<Value> float

Example: CORR:VAL?
 queries the value currently used for level correction.
 Response: -3
 the correction value is - 3 dB.

Usage: Query only

7.12.4 SOURce:DM Subsystem

This section contains the commands for generating the digital modulation signal. Two external inputs (EXT1 and EXT2) are available as data source. The settings for the external inputs are independently of the type of modulation selected.

<code>[:SOURce<hw>]:DM:ASK:DEPTH</code>	407
<code>[:SOURce<hw>]:DM:ASK:SOURce</code>	407
<code>[:SOURce<hw>]:DM:ASK:STATe</code>	408
<code>[:SOURce<hw>]:DM:EXTernal:POLarity<ch></code>	408
<code>[:SOURce<hw>]:DM:FSK:DEViation</code>	408
<code>[:SOURce<hw>]:DM:FSK:SOURce</code>	408
<code>[:SOURce<hw>]:DM:FSK:STATe</code>	409
<code>[:SOURce<hw>]:DM:PSK:DEViation</code>	409
<code>[:SOURce<hw>]:DM:PSK:SOURce</code>	409
<code>[:SOURce<hw>]:DM:PSK:STATe</code>	410

`[:SOURce<hw>]:DM:ASK:DEPTH <Depth>`

The command sets the modulation depth for ASK modulation.

Parameters:

`<Depth>` float
 Increment: 0.01
 *RST: 30 PCT

Example: `SOUR:DM:ASK 30PCT`
 sets the modulation depth for the amplitude modulation to 30%.

Options: R&S SMF-B20

`[:SOURce<hw>]:DM:ASK:SOURce <Source>`

The command selects the source for the ASK modulation signal.

Parameters:

`<Source>` EXT1 | EXT2 | PGENerator | RANDom
EXT 1/EXT 2
 Selects the external inputs (either EXT1 or EXT2) as the source for ASK modulation.
PGEN
 Selects the internal pulse generator as source for ASK modulation.
RAND
 Selects random pulses generated by the noise generator as the source for ASK modulation.
 *RST: EXT1

Example: `SOUR:DM:ASK:SOUR EXT1`
 selects the external input EXT1 as source for the amplitude modulation signal.

Options: R&S SMF-B20

[:SOURce<hw>]:DM:ASK:STATe <State>

The command activates/deactivates the ASK modulation.

Parameters:

<State> 0 | 1 | OFF | ON
*RST: OFF

Example: SOUR:DM:ASK:STAT ON
 activates the amplitude modulation.

Options: R&S SMF-B20

[:SOURce<hw>]:DM:EXTernal:POLarity<ch> <Polarity>

The command sets the polarity of the external modulation signal.

Parameters:

<Polarity> NORMal | INVerted
NORMal
The RF level is **ON** while the level is **HIGH**.
INVerted
The RF level is **ON** while the level is **LOW**.
*RST: NORMal

Example: SOUR:DM:EXT:POL NORM
 sets the marker output polarity to normal.

Options: R&S SMF-B20

[:SOURce<hw>]:DM:FSK:DEViation <Deviation>

The command sets the frequency deviation for FSK modulation.

Parameters:

<Deviation> float
Range: 0.0 Hz to 50.0 MHz
Increment: 0.1 Hz
*RST: 10 MHz

Example: SOUR:DM:FSK:DEV 20 MHz
 sets the deviation to 20 MHz.

Options: R&S SMF-B20

[:SOURce<hw>]:DM:FSK:SOURce <Source>

The command selects the source for the FSK modulation signal.

Parameters:

<Source>

EXT1 | EXT2 | PGENerator | RANDom

EXT 1/EXT 2

Selects the external inputs (either EXT1 or EXT2) as the source for FSK modulation.

PGEN

Selects the internal pulse generator as source for FSK modulation.

RAND

Selects random pulses generated by the noise generator as the source for FSK modulation.

*RST: EXT1

Example:

SOUR:DM:FSK:SOUR EXT1

selects the external input EXT1 as source for the frequency modulation signal.

Options:

R&S SMF-B20

[[:SOURce<hw>]:DM:FSK:STATe <State>

The command activates/deactivates the FSK modulation.

Parameters:

<State>

0 | 1 | OFF | ON

*RST: OFF

Example:

SOUR:DM:FSK:STAT ON

activates the frequency modulation.

Options:

R&S SMF-B20

[[:SOURce<hw>]:DM:PSK:DEVIation <Deviation>

The command sets the phase deviation for PSK modulation.

Parameters:

<Deviation>

float

Range: 0 to 100

*RST: 30 RAD

Example:

SOUR:DM:PSK:DEV 30RAD

sets the deviation to 30 RAD.

Options:

R&S SMF-B20

[[:SOURce<hw>]:DM:PSK:SOURce <Source>

The command selects the source for the PSK modulation signal.

Parameters:

<Source>

EXT1 | EXT2 | PGENerator | RANDom

EXT 1/EXT 2

Selects the external inputs (either EXT1 or EXT2) as the source for PSK modulation.

PGEN

Selects the internal pulse generator as source for PSK modulation.

RAND

Selects random pulses generated by the noise generator as the source for PSK modulation.

*RST: EXT1

Example:

SOUR:DM:PSK:SOUR EXT1

selects the external input EXT1 as source for the phase modulation signal.

Options:

R&S SMF-B20

[:SOURce<hw>]:DM:PSK:STATe <State>

The command activates/deactivates the PSK modulation.

Parameters:

<State>

0 | 1 | OFF | ON

*RST: OFF

Example:

SOUR:DM:PSK:STAT ON

activates the phase modulation.

Options:

R&S SMF-B20

7.12.5 SOURce:FM Subsystem

The FM subsystem contains the commands for checking the frequency modulation.

Characteristics which are valid for all modulations and the LF Output are configured in the SOURce:LFOuTput subsystem (e.g. frequency). The external signal is input at the EXT1 and/or EXT2 connector. Internal and external modulation source can be selected at the same time, thus enabling two-tone FM modulation.

For information about the required options, see [chapter 5.5.3, "Frequency Modulation \(FM\)"](#), on page 221.

[:SOURce<hw>]:FM<ch>[:DEViation]	411
[:SOURce<hw>]:FM:MODE	411
[:SOURce<hw>]:FM:RATio	411
[:SOURce<hw>]:FM<ch>:SOURce	412
[:SOURce<hw>]:FM<ch>:STATe	412

[[:SOURce<hw>]:FM<ch>[:DEViation] <Deviation>

The command enters the deviation of the FM signal.

Parameters:

<Deviation> float
 Range: 0.0 Hz to 25.0 MHz
 *RST: 1E3

Example: FM1:DEV 3kHz
 sets the modulation depth of 3 kHz for path 1.

Options: R&S SMF-B20

[[:SOURce<hw>]:FM:MODE <Mode>

The command selects the mode for the frequency modulation.

Parameters:

<Mode> NORMal | LNOise

NORMal

The maximum range for modulation bandwidth and FM deviation is available.

LNOise

Frequency modulation with phase noise and spurious characteristics close to CW mode. The range for modulation bandwidth and FM deviation is reduced (see data sheet).

*RST: NORMal

Example: FM:MODE NORM
 selects normal mode for external frequency modulation.

Usage: SCPI confirmed

Options: R&S SMF-B20

[[:SOURce<hw>]:FM:RATio <Ratio>

The command sets the path 1/path 2 ratio in percent.

Parameters:

<Ratio> float
 Range: 0 to 100
 Increment: 0.01

Example: FM:RAT 50PCT
 sets the path 1/path 2 ratio to 50 percent.

Options: R&S SMF-B20

[[:SOURce<hw>]:FM<ch>:SOURce <Source>

Selects the source for the FM signal.

Parameters:

<Source> LF1 | LF2 | NOISe | EXT1 | EXT2
*RST: EXT1

Example:

FM1 : SOUR LF2
selects the LF generator 2 as internal modulation source for path 1.

Options:

R&S SMF-B20

[[:SOURce<hw>]:FM<ch>:STATe <State>

The command activates/deactivates frequency modulation.

Activation of frequency modulation deactivates phase modulation.

Correlation: FM ON deactivates phase modulation.

Parameters:

<State> 0 | 1 | OFF | ON
*RST: OFF

Example:

FM1 : STAT ON
activates FM modulation for path 1.

Options:

R&S SMF-B20

7.12.6 SOURce:FREQuency Subsystem

This subsystem contains the commands used to define the frequency settings for the RF sources and sweeps.

[[:SOURce<hw>]:FREQuency:CENTer.....	413
[[:SOURce<hw>]:FREQuency[:CW]:FIXed].....	413
[[:SOURce<hw>]:FREQuency[:CW]:FIXed]:RCL.....	414
[[:SOURce<hw>]:FREQuency:MANual.....	414
[[:SOURce<hw>]:FREQuency:MODE.....	415
[[:SOURce<hw>]:FREQuency:MULTiplier.....	416
[[:SOURce<hw>]:FREQuency:OFFSet.....	416
[[:SOURce<hw>]:FREQuency:SPAN.....	416
[[:SOURce<hw>]:FREQuency:START.....	417
[[:SOURce<hw>]:FREQuency:STOP.....	417
[[:SOURce<hw>]:FREQuency:STEP[:INCRement].....	418
[[:SOURce<hw>]:FREQuency:STEP:MODE.....	418

[[:SOURce<hw>]:FREQUENCY:CENTer <Center>

The command sets the center frequency of the sweep. This setting in combination with the span setting ([SOURce:]FREQUENCY:SPAN) defines the sweep range.

This command is linked to the commands [SOURce:]FREQUENCY:START and [SOURce:]FREQUENCY:STOP, i.e. changing these values causes the CENTER value to change, and vice versa:

$$\text{CENTer} = (\text{START} + \text{STOP}) / 2$$

As with the "Frequency" value entered in the header, the OFFSet value is also taken into consideration with this command. The specified value range is therefore only effective if OFFSet is set to 0. The value range for other OFFset values can be calculated using the following formula:

$$100 \text{ kHz} + \text{OFFSet} + \text{MULTiplier} \dots \text{RF}_{\text{max}} + \text{OFFSet} + \text{MULTiplier}$$

Parameters:

<Center>	float
	Range: 100kHz to RFmax (RFmax depending on model)
	Increment: 0.01Hz
	*RST: 10GHz
	Default unit: Hz

Example:

```
FREQ:CENT 400 MHz
```

sets the center frequency for the frequency sweep to 400 MHz.

```
FREQ:SPAN 200 MHz
```

sets a span of 200 MHz. This sets the sweep range to 300 MHz to 500 MHz.

Usage:

SCPI confirmed

[[:SOURce<hw>]:FREQUENCY[:CW]:FIXed] <Fixed>

The command sets the frequency of the RF output signal for CW mode (SOURce:FREQUENCY:MODE CW). In Sweep mode (SOURce:FREQUENCY:MODE SWEep), this value is linked to the current sweep frequency.

In addition to a numerical value, it is also possible to specify UP and DOWN. The frequency is then increased or decreased by the value which is set under [SOURce<[1] | 2>:]FREQUENCY:STEP.

As with the "FREQ" value entered in the display, the OFFSet value is also taken into consideration with this command. The specified value range is therefore only effective if OFFSet is set to 0. The value range for other OFFset values can be calculated using the following formula:

$$100 \text{ kHz} + \text{OFFSet} + \text{MULTiplier} \dots \text{RF}_{\text{max}} + \text{OFFSet} + \text{MULTiplier}$$

Correlation: FREQ for FREQ:MODE SWE is linked to sweep frequency.

Parameters:

<Fixed> float
 Range: 100kHz to RFmax
 Increment: 0.01Hz
 *RST: 1GHz
 Default unit: Hz

Example:

FREQ 500kHz
 sets the frequency of RF output signal A to 500 kHz.

Usage:

SCPI confirmed

[:SOURce<hw>]:FREQuency[:CW][:FIXed]:RCL <Rcl>

The command determines whether the current frequency setting is retained or whether the stored frequency setting is adopted when an instrument configuration is loaded.

*RST does not affect this setting.

Parameters:

<Rcl> INCLude | EXCLude

INCLude

The stored frequency is also loaded when a stored instrument configuration is loaded.

EXCLude

The RF frequency is not loaded when a stored instrument configuration is loaded. The current frequency is retained.

*RST: no default

Example:

FREQ:RCL INCL
 The stored frequency is set if the Recall command is called.

Usage:

SCPI confirmed

[:SOURce<hw>]:FREQuency:MANual <Manual>

In Sweep mode (:SOUR:FREQ:MODE SWE) the command sets the frequency for the next sweep step in the "Step" sweep mode (SOUR:SWE:MODE MAN). Here only frequency values between the settings [SOUR]:FREQ:STAR and . . . :STOP are permitted. Each sweep step is triggered by a separate SOUR:FREQ:MAN command.

As with the "Frequency" value entered in the header, the OFFSet value is also taken into consideration with this command. The specified value range is therefore only effective if OFFSet is set to 0. The value range for other OFFset values can be calculated using the following formula:

START + OFFSet + MULTiplier ... STOP +OFFSet + MULTiplier

Parameters:

<Manual> float
 Range: START to STOP
 Increment: 0.01Hz
 *RST: 10 GHz
 Default unit: Hz

Example:

SWE:MODE MAN
 sets the Step sweep mode.

Example:

FREQ:MAN 500MHz
 sets an RF frequency of 500 MHz for the next step in the Step sweep mode.
 FREQ:MODE SWE
 sets the Frequency Sweep mode. An RF frequency of 500 MHz is output.
 FREQ:MAN 550MHz
 triggers the next sweep step with an RF frequency of 550 MHz.

Usage:

SCPI confirmed

[[:SOURce<hw>]:FREQuency:MODE <Mode>

The command sets the instrument operating mode and therefore also the commands used to set the output frequency.

Parameters:

<Mode> CW | FIXed | SWEep | LIST

CW|FIXed

The instrument operates in fixed-frequency mode; CW and FIXed are synonyms. The output frequency is set with :SOURce:FREQuency:CW|FIXed.

SWEep

The instrument operates in SWEep mode. The frequency is set using the commands SOURce:FREQuency:START; STOP; CENTer; SPAN; MANual.

LIST

The instrument processes a list of frequency and level settings for the selected path.

The List mode settings are made in the [SOURce:LIST Subsystem](#). The setting SOURce:FREQuency:MODE LIST also sets the command SOURce:POWer:MODE automatically to LIST.

Correlation: FREQ:MODE LIST sets POW:MODE LIST

*RST: CW

Example:

FREQ:MODE SWE
 sets the SWEep mode. The settings under SOURce:FREQuency:START; STOP; CENTer; SPAN; MANual become effective.

Usage: SCPI confirmed

[:SOURce<hw>]:FREQUENCY:MULTIPLIER <Multiplier>

The command sets the value for the multiplication factor of a subsequent downstream instrument.

Parameters:

<Multiplier> float
 Range: 1 to 10000
 *RST: 1

Example: `FREQ:MULT 1`
 sets the multiplication factor to 1.

[:SOURce<hw>]:FREQUENCY:OFFSET <Offset>

The command sets the frequency offset of a downstream instrument, e.g. a mixer. If a frequency offset is entered, the frequency entered with `SOURce:FREQUENCY:...` no longer corresponds to the RF output frequency. The following correlation applies:

`SOURce:FREQUENCY:...` = RF output frequency + `SOURce:FREQUENCY:OFFSET`.

Entering an offset does not change the RF output frequency, but rather the query value of `SOURce:FREQUENCY:...`

Parameters:

<Offset> float
 Range: -67GHz to 67GHz
 Increment: 0.01Hz
 *RST: 0Hz
 Default unit: Hz

Example: `FREQ:OFFS 500kHz`
 sets the frequency offset to 500 kHz.

Usage: SCPI confirmed

**[:SOURce<hw>]:FREQUENCY:SPAN **

This command specifies the span for the sweep. This setting in combination with the center frequency setting (`[SOUR]:FREQ:CENT`) defines the sweep range.

This command is linked to the commands `[SOUR]:FREQ:STAR` and `[:SOUR]:FREQ:STOP`, i.e. changing these values causes the `SPAN` value to change, and vice versa:

$SPAN = (STOP - START)$

Negative values for `SPAN` are permitted; `START > STOP` then applies.

Parameters:

 float
 Range: 100 kHz to RFmax
 Increment: 0.01Hz
 *RST: 4 GHz

Example:

FREQ:CENT 400 MHz
 sets the center frequency of the frequency sweep to 400 MHz.
 FREQ:SPAN 200 MHz
 sets a span of 200 MHz. This sets the sweep range to 300 MHz to 500 MHz.

Usage: SCPI confirmed

[[:SOURce<hw>]:FREQUENCY:START <Start>

This command sets the start frequency for the sweep mode. *START* can be greater than *STOP*.

This command is linked to the commands [SOUR]:FREQ:CENT and [SOUR]:FREQ:SPAN, i.e. changing these values causes the *START* value to change, and vice versa:

$$START = (CENTer - SPAN/2).$$

As with the "Frequency" value entered in the header, the *OFFSET* value is also taken into consideration with this command. The specified value range is therefore only effective if *OFFSET* is set to 0. The value range for other *OFFSET* values can be calculated using the following formula:

$$100 \text{ kHz} + OFFSET + MULTIPLIER \dots RF_{max} + OFFSET + MULTIPLIER$$

Parameters:

<Start> float
 Range: 100kHz to RFmax
 Increment: 0.01Hz
 *RST: 1 GHz

Example:

FREQ:START 1 MHz
 sets the start frequency for the frequency sweep to 1 MHz.
 FREQ:STOP 2 GHz
 sets the stop frequency for the frequency sweep to 2 GHz.

Usage: SCPI confirmed

[[:SOURce<hw>]:FREQUENCY:STOP <Stop>

This command sets the stop frequency for the sweep mode. *STOP* can be less than *START*.

This command is linked to the commands [[:SOUR]:FREQ:CENT and [[:SOUR]:FREQ:SPAN, i.e. changing these values causes the *START* value to change, and vice versa:

$$\text{STOP} = (\text{CENTer} + \text{SPAN}/2)$$

As with the "Frequency" value entered in the header, the `OFFSet` value is also taken into consideration with this command. The specified value range is therefore only effective if `OFFSet` is set to 0. The value range for other `OFFSet` values can be calculated using the following formula:

$$100 \text{ kHz} + \text{OFFSet} + \text{MULTIplier} \dots \text{RF}_{\text{max}} + \text{OFFSet} + \text{MULTIplier}$$

Parameters:

<Stop> float
 Range: 100kHz to RFmax
 Increment: 0.01Hz
 *RST: 5 GHz
 Default unit: Hz

Example:

`FREQ:STOP 2 GHz`
 sets the stop frequency for the frequency sweep to 2 GHz.
`FREQ:STAR 1 MHz`
 sets the start frequency for the frequency sweep to 1 MHz.

Usage: SCPI confirmed

[[:SOURce<hw>]:FREQuency:STEP[:INCRement] <Increment>

The command sets the step width for the frequency setting if the frequency values `UP/DOWN` are used and variation mode `SOUR:FREQ:STEP:MODE USER` is selected. The command is linked to "Variation Step" for manual control, i.e. the command also sets the step width of the rotary knob for "Variation Active" on.

Parameters:

<Increment> float
 Range: 1 MHz to 10 GHz
 Increment: 0.01Hz
 *RST: 1MHz

Example:

`FREQ:STEP 50 kHz`
 sets the step width for the frequency setting to 50 kHz.

[[:SOURce<hw>]:FREQuency:STEP:MODE <Mode>

This command activates (`USER`) or deactivates (`DECimal`) the user-defined step width used when varying the frequency value with the frequency values `UP/DOWN`. The command is linked to the command "Variation Active" for manual control, i.e. the command also activates/deactivates the user-defined step width used when varying the frequency value with the rotary knob.

Parameters:

<Mode> DECimal | USER
 *RST: DECimal

Example: `FREQ:STEP 50 kHz`
 sets the step width for the frequency setting to 50 kHz.
 `FREQ:STEP:MODE USER`
 activates this step width for frequency variation with the rotary knob
 (manual control) and with frequency values UP/DOWN (remote
 control).

7.12.7 SOURce:INPut Subsystem

The `SOURce:INPut` subsystem contains the commands for configuring the inputs for external modulation signals. The instrument trigger setting influences all sweeps and is effective in the List mode (Instrument Trigger).

<code>[:SOURce<hw>]:INPut:MODext:COUPling<ch></code>	419
<code>[:SOURce<hw>]:INPut:MODext:IMPedance<ch></code>	419
<code>[:SOURce]:INPut:TRIGger:SLOPe</code>	420

`[:SOURce<hw>]:INPut:MODext:COUPling<ch>` <Coupling>

The command selects the coupling mode for external feed via EXT 1 and/or EXT 2 input.

Parameters:

<Coupling> AC | DC

AC
 The DC voltage component is disconnected from the modulation signal.

DC
 The modulation signal is not changed.

*RST: AC

Example: `SOUR:INP:MOD:COUP1 AC`
 selects the coupling mode AC for external modulation input
 EXT1.

Options: R&S SMF-B20

`[:SOURce<hw>]:INPut:MODext:IMPedance<ch>` <Impedance>

The commands set the impedance for external feed via the EXT 1 or EXT 2 input.

Parameters:

<Impedance> G50 | G600 | G100K

G100k
 100 kOhm to ground

G600
 600 Ohm to ground

G50
 50 Ohm to ground

*RST: G100K

Example: `INP:MOD:IMP1 G50`
the EXT input is set to 50 Ohm to ground.

Options: R&S SMF-B20

[[:SOURce]:INPut:TRIGger:SLOPe <Slope>

Sets the polarity of the active slope of an externally applied trigger signal at the trigger input (BNC connector at the rear of the instrument).

The setting is effective for both inputs at the same time.

Parameters:

<Slope> NEGAtive | POSitive
*RST: POSitive

Example: `INP:TRIG:SLOP NEG`
the active slope of the external trigger signal at the trigger input is the falling slope.

7.12.8 SOURce:LFOutput Subsystem

This subsystem contains the commands for setting the LF signal source in CW and Sweep mode as well as for analog modulation.

Two internal LF generators and a noise generator are available with option R&S SMF-B20.

The suffix for `LFOutput<ch>` denotes the selected LF generator. The source for the LF sweep (LF generator 1 or 2) is selected with command `SOURce:LFOutput:SWEep:FREQuency:SOURce`.

Example

The following example shows how to set an LF sweep.

1. Set the sweep range.
`LFOutput:FREQuency:START 4 kHz`
`LFOutput:FREQuency:STOP 10 kHz`
2. Select linear or logarithmic sweep spacing.
`LFOutput:SWEep[:FREQuency]:SPACing LIN`
3. Set the step width and dwell time.
`LFOutput:SWEep[:FREQuency]:STEP[:LINear] 100 Hz`
`LFOutput:SWEep[:FREQuency]:DWELL 20 ms`
4. Determine the sweep mode.
`LFOutput:SWEep:MODE AUTO`
5. Determine the trigger.
`TRIGger0:SOURce SINGLE`

6. Activate the sweep.

```
LFOutput:FREQUENCY:MODE SWEep
```

7. Trigger the sweep (depending on the mode).

```
LFOutput:SWEep:EXECute
```

<code>[:SOURce]:LFOutput<ch>:BANDwidth</code>	422
<code>[:SOURce]:LFOutput<ch>:FREQUENCY</code>	422
<code>[:SOURce]:LFOutput:FREQUENCY:MANual</code>	422
<code>[:SOURce]:LFOutput:FREQUENCY:MODE</code>	423
<code>[:SOURce]:LFOutput:FREQUENCY:STARt</code>	423
<code>[:SOURce]:LFOutput:FREQUENCY:STOP</code>	424
<code>[:SOURce]:LFOutput:MONitor:MODE</code>	424
<code>[:SOURce]:LFOutput:OFFSet</code>	425
<code>[:SOURce]:LFOutput<ch>:SOURce</code>	425
<code>[:SOURce]:LFOutput<ch>[:STATe]</code>	425
<code>[:SOURce]:LFOutput:SWEep[:FREQUENCY]:DWELL</code>	426
<code>[:SOURce]:LFOutput:SWEep[:FREQUENCY]:EXECute</code>	426
<code>[:SOURce]:LFOutput:SWEep[:FREQUENCY]:LFSource</code>	426
<code>[:SOURce]:LFOutput:SWEep[:FREQUENCY]:MARKer:ACTive</code>	427
<code>[:SOURce]:LFOutput:SWEep[:FREQUENCY]:MARKer:AMPLitude</code>	427
<code>[:SOURce]:LFOutput:SWEep[:FREQUENCY]:MARKer:AOFF</code>	427
<code>[:SOURce]:LFOutput:SWEep[:FREQUENCY]:MARKer<ch>:FREQUENCY</code>	427
<code>[:SOURce]:LFOutput:SWEep[:FREQUENCY]:MARKer<ch>:FSTate</code>	428
<code>[:SOURce]:LFOutput:SWEep[:FREQUENCY]:MARKer<ch>:VSTate</code>	428
<code>[:SOURce]:LFOutput:SWEep[:FREQUENCY]:MODE</code>	428
<code>[:SOURce]:LFOutput:SWEep[:FREQUENCY]:POINTs</code>	429
<code>[:SOURce]:LFOutput:SWEep[:FREQUENCY]:SHAPE</code>	430
<code>[:SOURce]:LFOutput:SWEep[:FREQUENCY]:SPACing</code>	430
<code>[:SOURce]:LFOutput:SWEep[:FREQUENCY]:STEP[:LINear]</code>	431
<code>[:SOURce]:LFOutput:SWEep[:FREQUENCY]:STEP:LOGarithmic</code>	431
<code>[:SOURce]:LFOutput:SWEep:VOLTage:DWELL</code>	432
<code>[:SOURce]:LFOutput:SWEep:VOLTage:EXECute</code>	432
<code>[:SOURce]:LFOutput:SWEep:VOLTage:LFSource</code>	433
<code>[:SOURce]:LFOutput:SWEep:VOLTage:MARKer:ACTive</code>	433
<code>[:SOURce]:LFOutput:SWEep:VOLTage:MARKer:AOFF</code>	433
<code>[:SOURce<hw>]:LFOutput:SWEep:VOLTage:MARKer<ch>:VOLTage</code>	433
<code>[:SOURce<hw>]:LFOutput:SWEep:VOLTage:MARKer<ch>:VSTate</code>	434
<code>[:SOURce]:LFOutput:SWEep:VOLTage:MODE</code>	434
<code>[:SOURce]:LFOutput:SWEep:VOLTage:POINTs</code>	434
<code>[:SOURce]:LFOutput:SWEep:VOLTage:SHAPE</code>	435
<code>[:SOURce]:LFOutput:SWEep:VOLTage:STEP[:LINear]</code>	435
<code>[:SOURce]:LFOutput<ch>:SHAPE</code>	436
<code>[:SOURce]:LFOutput<ch>:SHAPE:PULSe:DCYCLE</code>	436
<code>[:SOURce]:LFOutput<ch>:SHAPE:PULSe:PERiod</code>	436
<code>[:SOURce]:LFOutput<ch>:SHAPE:PULSe:WIDTh</code>	436
<code>[:SOURce]:LFOutput<ch>:SHAPE:TRAPeZe:FALL</code>	437
<code>[:SOURce]:LFOutput<ch>:SHAPE:TRAPeZe:HIGH</code>	437
<code>[:SOURce]:LFOutput<ch>:SHAPE:TRAPeZe:PERiod</code>	437
<code>[:SOURce]:LFOutput<ch>:SHAPE:TRAPeZe:RISE</code>	438

<code>[[:SOURce]:LFOOutput<ch>:SHAPE:TRiangle:PERiod</code>	438
<code>[[:SOURce]:LFOOutput<ch>:SHAPE:TRiangle:RISE</code>	438
<code>[[:SOURce]:LFOOutput<ch>:VOLTage</code>	439
<code>[[:SOURce]:LFOOutput:VOLTage:MANual</code>	439
<code>[[:SOURce]:LFOOutput:VOLTage:MODE</code>	440
<code>[[:SOURce]:LFOOutput:VOLTage:STARt</code>	440
<code>[[:SOURce]:LFOOutput:VOLTage:STOP</code>	441

[[:SOURce]:LFOOutput<ch>:BANDwidth <Bandwidth>

The command selects the bandwidth for the external feed via the EXT 1 and/or EXT 2 input. Selection 200 kHz und 10 MHz are available.

Parameters:

<Bandwidth> BW0M2 | BW10m
 *RST: BW10m

Example:

`SOUR:LFO1:BAND BW0M2`
 selects the bandwidth 200 kHz for the external feed.

Options: R&S SMF-B20

[[:SOURce]:LFOOutput<ch>:FREQuency <Frequency>

The command sets the frequency of the LF signal for CW mode (`:SOUR:MODE CW`). The setting is valid for all analog modulations (AM/FM/PhiM) with internal modulation source and for the LF Output.

In sweep mode (`SOUR:LFO:FREQ:MODE SWE`), the frequency is linked to the sweep frequency.

Correlation: `LFO:FREQ` for `LFO:FREQ:MODE SWE` linked to sweep frequency.

Parameters:

<Frequency> float
 Increment: 0.1 Hz
 *RST: 1KHz

Example:

`LFO2:FREQ 5kHz`
 sets the frequency of the LF generator 2 signal to 5 kHz.

Options: R&S SMF-B20

[[:SOURce]:LFOOutput:FREQuency:MANual <Manual>

In Sweep mode (`SOUR:LFO:FREQ:MODE SWE`) the command sets the frequency for the next sweep step in the "Step" sweep mode (`SOUR:LFO:SWE:MODE MAN`). Here only frequency values between the settings `SOUR:LFO:FREQ:STAR` and `...:STOP` are permitted. Each sweep step is triggered by a separate `SOUR:LFO:FREQ:MAN` command.

Parameters:

<Manual> float
 Range: START to STOP
 Increment: 0.1 Hz
 *RST: 1 kHz

Example:

LFO:SWE:MODE MAN
 sets the "Step" sweep mode.
 LFO:FREQ:MAN 5 kHz
 sets an LF frequency of 5 kHz for the next step in the "Step" sweep mode.
 LFO:FREQ:MODE SWE
 sets the LF Sweep mode. An LF frequency of 5 kHz is output.
 LFO:FREQ:MAN 5.1 kHz
 triggers the next sweep step with a frequency of 5.1 kHz.

Options: R&S SMF-B20

[:SOURce]:LFOutput:FREQuency:MODE <Mode>

The command sets the instrument operating mode and therefore also the commands used to set the output frequency.

The source for the LF sweep is selected with command `[:SOURce]:LFOutput:SWEep [:FREQuency]:LFSource`.

Parameters:

<Mode> CW | FIXed | SWEep

CW|FIXed

The instrument operates in fixed-frequency mode. CW and FIXed are synonyms.

The output frequency is set with `[:SOURce]:LFOutput<ch>:FREQuency`.

SWEep

The instrument operates in SWEep mode. The frequency is set using the commands `[:SOURce]:LFOutput:FREQuency:START`, `[:SOURce]:LFOutput:FREQuency:STOP` or `[:SOURce]:LFOutput:FREQuency:MANual`.

*RST: CW

Example:

LFO:FREQ:MODE SWE
 sets the SWEep mode. The settings under `SOURce:LFOutput:FREQuency:START`; `STOP`; `MANual` become effective.

Options: R&S SMF-B20

[:SOURce]:LFOutput:FREQuency:START <Start>

This command sets the start frequency for the LF Sweep mode.

Parameters:

<Start> float
 Range: 0.1 Hz to 1 MHz
 Increment: 0.1 Hz
 *RST: 1 kHz

Example:

RST*
 activates all presettings.
 LFO:SWE:MODE AUTO
 sets the AUTO sweep mode, i.e. each trigger triggers a complete sweep.
 TRIGO:SOUR SING
 sets the SINGLE trigger mode, i.e. the sweep is triggered by the command :LFOOutput:SWEep:EXECute or *TRG.
 LFO:FREQ:STAR 100 kHz
 sets the start frequency for the LF sweep to 100 kHz.
 LFO:FREQ:STOP 200 kHz
 sets the stop frequency of the LF sweep to 200 kHz.
 LFO:FREQ:MODE SWE
 sets the LF sweep mode.
 LFO:SWE:EXEC
 a one-off LF sweep from 100 kHz to 200 kHz is performed. The linear step width is 1 kHz with a dwell time of 15 ms (preset values).

Options: R&S SMF-B20

[:SOURce]:LFOOutput:FREQuency:STOP <Stop>

This command sets the stop frequency for the LF sweep.

Parameters:

<Stop> float
 Range: 0.1 Hz to 1 MHz
 Increment: 0.1 Hz
 *RST: 50 kHz

Example:

LFO:FREQ:STOP 200 kHz
 sets the stop frequency for the LF sweep to 200 kHz.
 LFO:FREQ:STAR 100 kHz
 sets the start frequency for the LF sweep to 100 kHz.

Options: R&S SMF-B20

[:SOURce]:LFOOutput:MONitor:MODE <Mode>

The command selects the LF output monitoring mode. The settings for the LF output are synchronized to amplitude modulation or frequency/phase modulation settings.

Parameters:

<Mode> OFF | AM | FMPM
 *RST: OFF

Example: `SOUR:LFO:MON:MODE AM`
sets the LF output settings to be synchronized to the amplitude modulation signal.

Options: R&S SMF-B20

[:SOURce]:LFOutput:OFFSet <Offset>

The command sets a DC offset at the LF Output.

Parameters:

<Offset> float
Range: -4 to 4 V
Increment: 0.001 V
*RST: 0 V

Example: `LFO:OFFS 2 V`
sets a DC OFFSet of 2 V

Usage: SCPI confirmed

Options: R&S SMF-B20

[:SOURce]:LFOutput<ch>:SOURce <Source>

The command selects the internal and/or external source to be used for the LF Output signal.

Parameters:

<Source> LF1 | LF2 | NOISe | EXT1 | EXT2
*RST: LF1

Example: `SOUR:LF01:SOUR NOIS`
selects the noise generator as source for the LF output signal.

Options: R&S SMF-B20

[:SOURce]:LFOutput<ch>[:STATE] <State>

The command activates/deactivates the LF output.

Parameters:

<State> 0 | 1 | OFF | ON
*RST: OFF

Example: `SOUR:LF01 ON`
activates the LF output. The settings under `LFO:FREQ` and `LFO:SWE` become effective.

Options: R&S SMF-B20

[[:SOURce]:LFOutput:SWEep[:FREQUENCY]:DWELI <Dwell>

The command sets the dwell time for each frequency step of the sweep.

Tip: It is recommended to switch off the "GUI Update" for optimum sweep performance especially with short dwell times ([SYSTem:DISPlay:UPDate OFF](#)).

Parameters:

<Dwell> float
 Range: 10.0E-3 to 100
 Increment: 100.0E-6
 *RST: 10.0E-3
 Default unit: s

Example: LFO:SWE:DWEL 20 ms
 sets a dwell time of 20 ms.

Options: R&S SMF-B20

[[:SOURce]:LFOutput:SWEep[:FREQUENCY]:EXECute

The command immediately starts an LF sweep.

The MODE setting determines which sweep is executed, e.g.

`SOURce:LFOutput:SWEep:FREQUENCY:MODE STEP`. The command corresponds to the manual-control command `EXECUTE SINGLE SWEEP`.

The command corresponds to the manual-control [Execute Single Sweep - LF Sweep](#).

Example: LFO:SWE:MODE SING
 sets the single cycle mode of the LF sweep.
 LFO:SWE:EXEC
 starts one cycle of the LF sweep.

Usage: Event

Options: R&S SMF-B20

[[:SOURce]:LFOutput:SWEep[:FREQUENCY]:LFSource <Lfsource>

The command selects the source for the LF sweep.

Parameters:

<LFSource> LF1 | LF2
 *RST: LF1

Example: LFO:SWE:LFS LF2
 selects LF generator 2 as the LF frequency sweep source.

Options: R&S SMF-B20

[[:SOURce]:LFOutput:SWEep[:FREQUENCY]:MARKer:ACTIVE <Active>

The command activates the selected marker. The active marker is output with a higher voltage than all other markers.

Parameters:

<Active> NONE | M01 | M02 | M03 | M04 | M05 | M06 | M07 | M08 | M09 | M10
 *RST: NONE

Example: SOUR:LFO:SWE:FREQ:MARKer:ACT M05
 switches on marker 5.

Options: R&S SMF-B20

[[:SOURce]:LFOutput:SWEep[:FREQUENCY]:MARKer:AMPLitude <Amplitude>

Sets the amplitude marker attenuation. This value is valid for all markers.

Correlation: The output level reduction is applied to a marker with
 SOUR:LFO:SWE:MARK<[1]...10>:PST ON

Parameters:

<Amplitude> float
 Range: 0 to 3
 *RST: 1

Example: SOUR:LFO:SWE:FREQ:MARK:AMPL 1
 The output level is reduced by 1 dB on reaching the mark.

Options: R&S SMF-B20

[[:SOURce]:LFOutput:SWEep[:FREQUENCY]:MARKer:AOFF

The command switches off all active frequency markers. The command triggers an event and therefore has no query form and no *RST value.

Example: SOUR:LFO:SWE:FREQ:MARK:AOFF
 switches off all frequency markers.

Usage: Event

[[:SOURce]:LFOutput:SWEep[:FREQUENCY]:MARKer<ch>:FREQUENCY <Frequency>

The command sets the frequency of the selected marker. If the marker is switched on, the signal level at the MARKER output changes on reaching the frequency mark.

Parameters:

<Frequency> float
 *RST: 300 MHz

Example: `SOUR:LFO:SWE:MARK1:FRQ 200Hz`
sets the frequency mark for marker 1 to 200 Hz.

Options: R&S SMF-B20

[[:SOURce]:LFOutput:SWEep[:FREQUENCY]:MARKer<ch>:FSTate <Fstate>

The command activates or deactivates the selected marker. If the marker is switched on, the signal level at the MARKER output changes on reaching the frequency mark.

Parameters:

<Fstate> 0 | 1 | OFF | ON
*RST: OFF

Example: `SOUR:LFO:SWE:FREQ:MARK1:FST ON`
switches on marker 1.

Options: R&S SMF-B20

[[:SOURce]:LFOutput:SWEep[:FREQUENCY]:MARKer<ch>:VSTate <Vstate>

The command activates or deactivates the selected amplitude marker. If activated, the level is reduced by the amplitude entered with command `[[:SOURce]:LFOutput:SWEep[:FREQUENCY]:MARKer:AMPLitude` on reaching the mark.

Parameters:

<Vstate> 0 | 1 | OFF | ON
*RST: OFF

Example: `SOUR:LFO:SWE:FREQ:MARK1:VST ON`
the output level is reduced by a constant value if frequency marker 1 is executed.

Options: R&S SMF-B20

[[:SOURce]:LFOutput:SWEep[:FREQUENCY]:MODE <Mode>

The command sets the cycle mode of the LF sweep.

The assignment of the GPIB commands to the sweep modes is given in the description of the sweep menus.

Parameters:

<Mode>

AUTO | MANual | STEP

AUTO

Each trigger triggers exactly one complete sweep.

MANual

The trigger system is not active. Each frequency step of the sweep is triggered individually, either by varying the "Current Frequency" value using the rotary knob under manual control or by means of a :LFOuTput:FREQ:MAN command under remote control.

With manual control, the frequency increases or decreases (depending on the direction of the rotary encoder) by the value specified under SOUR:LFO:SWE:FREQ:STEP:LIN (linear spacing) or . . . :STEP:LOG (logarithmic spacing).

With remote control, the frequency increases by the value specified under LFO:SWE:FREQ:STEP:LIN|LOG which each sent [:SOURce]:LFOuTput:FREQuency:MANual command, irrespective the value entered there.

STEP

Each trigger triggers one sweep step only. The frequency increases by the value entered under

```
[SOURce:]LFOuTput:SWEep:STEP.
```

```
*RST:      AUTO
```

Example:

```
LFO:SWE:MODE AUTO
selects Mode Auto.
```

Options:

R&S SMF-B20

[:SOURce]:LFOuTput:SWEep[:FREQuency]:POINTs <Points>

The command sets the number of steps in an LF sweep.

The command is linked to the command :LFOuTput:SWEep[:FREQuency]:STEP as follows:

- for linear sweeps and START < STOP
 $POINTs = ((STOP - START) / STEP:LIN) + 1$
- for logarithmic sweeps and START < STOP
 $POINTs = ((\log STOP - \log START) / \log STEP:LOG) + 1$

If POINTs changes, the value of STEP is adjusted. The START and STOP value is retained.

Two separate POINTs values are used for linear or logarithmic sweep spacing (LFOuTput:SWEep[:FREQuency]:SPACing LIN | LOG). The command is always effective for the currently set sweep spacing.

Note: The value indicated in the menu and the value set/retrieved by this command differ by 1 as a rule. This is caused by a different calculation of the value indicated in the menu (e.g. linear spacing): $\text{Count} = (\text{Stop} - \text{Start}) / \text{Step} \cdot \text{Log}$. (i.e, the transitions are counted not the steps as in remote control). Also, the value is in any case an integer, thus may be rounded.

Parameters:

<Points> float
 Increment: 1
 *RST: 100

Example:

```
LFO:FREQ:STAR
sets the start frequency to 2 kHz.
LFO:FREQ:STOP
sets the stop frequency to 20 kHz
LFO:SWE:SPAC LIN
sets linear sweep spacing.
LFO:SWE:POIN 11
sets 11 sweep steps for linear sweep spacing. The sweep step
width (STEP) is automatically set to 2 kHz.
```

Options: R&S SMF-B20

[[:SOURce]:LFOutput:SWEep[:FREQuency]:SHAPe <Shape>

The command sets the cycle mode for a sweep sequence (shape).

Parameters:

<Shape> SAWTooth | TRIangle

SAWTooth

One sweep runs from start to stop frequency. Each subsequent sweep starts at the start frequency, i.e. the shape of the sweep sequence resembles a sawtooth.

TRIangle

One sweep runs from start to stop frequency and back, i.e. the shape of the sweep resembles a triangle. Each subsequent sweep starts at the start frequency.

*RST: SAWTooth

Example:

```
SOUR:LFO:SWE:SHAP TRI
selects the sweep cycle with alternating ascending and descend-
ing sweep directions.
```

[[:SOURce]:LFOutput:SWEep[:FREQuency]:SPACing <Spacing>

The command selects linear or logarithmic sweep spacing.

Parameters:

<Spacing> LINear | LOGarithmic
 *RST: LINear

Example: LFO:SWE:SPAC LIN
selects linear sweep spacing.

Options: R&S SMF-B20

[[:SOURce]:LFOOutput:SWEep[:FREQUENCY]:STEP[:LINear]] <Linear>

The command sets the step width for the linear sweep.

This command is linked to the command :LFOOutput:SWEep[:FREQUENCY]:POINTs as follow.

- for `START < STOP`:
$$\text{POINTs} = ((\text{STOP} - \text{START}) / \text{STEP:LIN}) + 1$$

If `STEP:LIN` changes, the value of `POINTs` is adjusted. The `START` and `STOP` value is retained.

Parameters:

<Linear> float
Range: 0 to STOP-START
Increment: 0.1 Hz

Example: LFO:FREQ:STAR
sets the start frequency to 2 kHz.
LFO:FREQ:STOP
sets the stop frequency to 20 kHz.
LFO:SWE:SPAC LIN
sets linear sweep spacing.
LFO:SWE:STEP 2 kHz
sets the sweep step width to 2 kHz. The number of sweep steps for linear sweep spacing (`POINTs`) is automatically set to 11.

Options: R&S SMF-B20

[[:SOURce]:LFOOutput:SWEep[:FREQUENCY]:STEP:LOGarithmic] <Logarithmic>

The command specifies the step width factor for logarithmic sweeps. The next frequency value of a sweep is calculated (for `START < STOP`) using the following formula:

New frequency = Old frequency + `STEP:LOG` x Old frequency

`STEP:LOG` therefore gives the fraction of the old frequency. The frequency is increased by this fraction for the next sweep step. Usually `STEP:LOG` is given in percent, whereby the suffix `PCT` must always be used.

The command is linked to the command :LFOOutput:SWEep[:FREQUENCY]:POINTs as follows:

- for logarithmic sweeps and `START < STOP`:
$$\text{POINTs} = ((\log \text{STOP} - \log \text{START}) / \log \text{STEP:LOG}) + 1$$

If `STEP:LOG` changes, the value of `POINTs` is adjusted. The `START` and `STOP` value is retained.

Parameters:

<Logarithmic> float
 Range: 0.01PCT to 100PCT
 Increment: 0.01PCT
 *RST: 1

Example:

LFO:FREQ:STAR
 sets the start frequency to 1 kHz.
 LFO:FREQ:STOP
 sets the stop frequency to 100 kHz.
 LFO:SWE:SPAC LOG
 sets logarithmic sweep spacing.
 LFO:SWE:STEP:LOG 10PCT
 sets the step width for logarithmic sweep spacing to 10% of the previous frequency in each instance.

Options: R&S SMF-B20

[[:SOURce]:LFOoutput:SWEep:VOLTage:DWELI <Dwell>

The command sets the time taken for each level step of the sweep.

Parameters:

<Dwell> float
 Range: 1.0E-3 to 100
 Increment: 100.0E-6
 *RST: 15.0E-3
 Default unit: s

Example:

SOUR:LFO:SWE:VOLT:DWEL 12m
 sets a dwell time of 12 ms for a level sweep.

Options: R&S SMF-B20

[[:SOURce]:LFOoutput:SWEep:VOLTage:EXECute

The command triggers a sweep. The sweep to be executed depends on the set sweep mode (`[[:SOURce]:LFOoutput:SWEep:VOLTage:MODE]`). The command corresponds to the manual-control command `Execute Trigger`.

The command triggers an event and therefore has no query form and no *RST value.

Example:

SOUR:LFO:SWE:VOLT:MODE STEP
 sets the STEP trigger mode, i.e. a trigger starts the sweep initially, and then the sweep is generated continuously.
 SOUR:LFO:SWE:VOLT:EXEC
 triggers a level sweep.

Options: R&S SMF-B20

[[:SOURce]:LFOutput:SWEep:VOLTage:LFSource <Lfsource>

The command selects the source for the LF level sweep.

Parameters:

<Lfsource> LF1 | LF2

Example:

SOUR:SWE:LFO:VOLT:LFS LF2
selects LF generator 2 as the LF frequency sweep source.

Options:

R&S SMF-B20

[[:SOURce]:LFOutput:SWEep:VOLTage:MARKer:ACTive <Active>

The command activates the selected marker. The active marker is output with an higher voltage than all other markers.

Parameters:

<Active> NONE | M01 | M02 | M03 | M04 | M05 | M06 | M07 | M08 | M09 | M10

*RST: NONE

Example:

SOUR:LFO:SWE:VOLT:MARK:ACT M05
sets marker 5 to be the active marker.

Options:

R&S SMF-B20

[[:SOURce]:LFOutput:SWEep:VOLTage:MARKer:AOFF

The command switches off all markers of level sweep. The command triggers an event and therefore has no query form and no *RST value.

Example:

SOUR:LFO:SWE:VOLT:MARK:AOFF
switches off all level markers.

[[:SOURce<hw>]:LFOutput:SWEep:VOLTage:MARKer<ch>:VOLTage <Voltage>

The command sets the voltage mark for the selected marker. If the marker is switched on, the signal level at the MARKER output changes on reaching the voltage mark.

Parameters:

<Voltage> float

Range: 0 to 6

*RST: 0 dBm

Example:

SOUR:LFO:SWE:VOLT:MARK1:VOLT -50
sets the voltage mark of marker 1 to -50 dBm.

Options:

R&S SMF-B20

[:SOURce<hw>]:LFOOutput:SWEep:VOLTAGE:MARKer<ch>:VSTate <Vstate>

The command switches on or off the selected marker. If the marker is switched on, the signal level at the MARKER output changes on reaching the voltage mark.

Parameters:

<Vstate> 0 | 1 | OFF | ON
 *RST: OFF

Example:

SOUR:LFO:SWE:VOLT:MARK1:VST ON
 switches on marker 1.

Options:

R&S SMF-B20

[:SOURce]:LFOOutput:SWEep:VOLTage:MODE <Mode>

The command sets the cycle mode of the LF level sweep.

Parameters:

<Mode> AUTO | MANual | STEP

AUTO

Each trigger triggers exactly one complete sweep.

MANual

The trigger system is not active. Each level step of the sweep is triggered individually, either by varying the **current level** value using the rotary knob under manual control or by means of a :VOLT:MAN command under remote control. With manual control, the level increases or decreases (depending on the direction of the rotary encoder) by the value specified under VOLT:STEP. With remote control, the level is set directly with the command VOLT:MAN.

STEP

Each trigger triggers one sweep step only. The level increases by the value entered
 under :SWEep:VOLTage:STEP:LOGarithmic.

Example:

LFO:SWE:VOLT:MODE AUTO
 selects mode "Auto" for a LF level sweep.

Options:

R&S SMF-B20

[:SOURce]:LFOOutput:SWEep:VOLTage:POINTS <Points>

The command defines the number of "LF Level" sweep steps. The command is linked to the command :SWEep:POWer:STEP as follows:

$$\text{POINTS} = (\text{STOP} - \text{START}) / \text{STEP:LOG} + 1$$

If POINTs changes, the value of STEP is adjusted. The START and STOP value is retained.

Note: The value indicated in the menu and the value set/retrieved by this command differ by 1 as a rule. This is caused by a different calculation of the value indicated in the menu: $\text{Count} = (\text{Stop} - \text{Start}) / \text{Step:Log}$. (i.e, the transitions are counted not the steps as in remote control) Also, the value is in any case an integer, thus may be rounded.

Parameters:

<Points> float

Example:

LFO:SWE:VOLT:POINTs 25
sets the number of sweep steps to 25.

Options:

R&S SMF-B20

[[:SOURce]:LFO:output:SWEep:VOLTage:SHAPE <Shape>

The command sets the cycle mode for a sweep sequence (shape).

Parameters:

<Shape> SAWTooth | TRIangle

SAWTooth

One sweep runs from the start level to the stop level. The subsequent sweep starts at the start level again, i.e. the shape of sweep sequence resembles a sawtooth.

TRIangle

One sweep runs from start to stop level and back, i.e. the shape of the sweep resembles a triangle. Each subsequent sweep starts at the start level again.

Example:

SOUR:LFO:SWE:VOLT:SHAP TRI
selects the sweep cycle with alternating ascending and descending sweep directions.

Options:

R&S SMF-B20

[[:SOURce]:LFO:output:SWEep:VOLTage:STEP[:LINear] <Linear>

The command sets the step width for the level setting if UP and DOWN are used as the level values and variation mode : SOUR:LFO:POW:STEP:MODE USER is selected. The command is linked to setting Variation Step for manual control, i.e. the command also sets the step width of the rotary knob for "Variation Active" on.

Parameters:

<Linear> float
Range: 0 to 6
*RST: 0.1 V

Example:

SOUR:LFO:SWE:VOLT:STEP:LIN 2 or VOLT:STEP 2
sets the step width for entering the LF level to 2 V.

Options:

R&S SMF-B20

[[:SOURce]:LFOutput<ch>:SHAPE <Shape>

The command selects the shape of the LF generator.

Parameters:

<Shape> SINE | SQUARE | TRIangle | TRAPEze
*RST: SINE

Example:

LFO:SHAP SQU
selects a rectangular shape for the signal of the LF generator.

Usage:

SCPI confirmed

Options:

R&S SMF-B20

[[:SOURce]:LFOutput<ch>:SHAPE:PULSE:DCYCLE <Dcycle>

The command sets the duty cycle for the shape pulse.

Parameters:

<Dcycle> float
Range: 0 to 100
Increment: 0.001 PCT
*RST: 50 PCT

Example:

SOUR:LFO2:SHAP:PULS:DCYC 50PCT
sets a duty cycle of 50% for the pulse shape of the signal of LF generator 1.

Options:

R&S SMF-B20

[[:SOURce]:LFOutput<ch>:SHAPE:PULSE:PERIOD <Period>

The command sets the period of the generated pulse. The period determines the repetition frequency of the internal signal.

Parameters:

<Period> float
Range: 1.00 μ s to 100 s
Increment: 0.01 μ s
*RST: 1 ms

Example:

SOUR:LFO2:SHAP:PULS:PER 10s
sets a pulse period of 10s for the pulse shape of the signal of LF generator 2.

Options:

R&S SMF-B20

[[:SOURce]:LFOutput<ch>:SHAPE:PULSE:WIDTH <Width>

The command sets the width of the generated pulse. The width determines the pulse length.

Parameters:

<Width> float
 Range: 1.0 μ s to 1. ms
 Increment: 0.01 μ s
 *RST: 1 ms

Example:

SOUR:LFO2:SHAP:PULS:WIDT 10s
 sets a pulse width of 10 s for the pulse shape of the signal of LF generator 2.

[:SOURce]:LFOOutput<ch>:SHAPE:TRAPeZe:FALL <Fall>

The command selects the fall time for the trapeze shape of the LF generator.

Parameters:

<Fall> float
 Range: 0.2 μ s to 2.5 s
 Increment: 200 ns
 *RST: 0.25 ms

Example:

SOUR:LFO2:SHAP:TRAP:FALL 100s
 selects a fall time of 100 s for trapezoid shape of the signal of LF generator 2.

Usage: SCPI confirmed

Options: R&S SMF-B20

[:SOURce]:LFOOutput<ch>:SHAPE:TRAPeZe:HIGH <High>

The command sets the high time for the trapeze shape of the LF generator.

Parameters:

<High> float
 Range: 0.2 μ s to 2.5 s
 Increment: 200 ns
 *RST: 1 μ s

Example:

SOUR:LFO2:SHAP:TRAP:HIGH 100s
 selects a high time of 100 s for trapeze shape of the signal of LF generator 2.

Usage: SCPI confirmed

Options: R&S SMF-B20

[:SOURce]:LFOOutput<ch>:SHAPE:TRAPeZe:PERiod <Period>

The command sets the period of the generated trapezoid shape.

Parameters:

<Period> float
 Range: 1.0 μ s to 100 s
 Increment: 0.01 μ s
 *RST: 1 ms

Example:

SOUR:LFO2:SHAP:TRAP:PER 100s
 sets a pulse period of 100 s for the trapezoid shape of the signal of LF generator 2.

Usage:

SCPI confirmed

Options:

R&S SMF-B20

[[:SOURce]:LFOutput<ch>:SHAPE:TRAPe:RISE <Rise>

The command selects the rise time for the trapeze shape of the LF generator.

Parameters:

<Rise> float
 Range: 0.2 μ s to 2.5 s
 Increment: 200 ns
 *RST: 0.25 ms

Example:

SOUR:LFO2:SHAP:TRAP:RISE 100s
 selects a rise time of 100 s for trapeze shape of the signal of LF generator 2.

Options:

R&S SMF-B20

[[:SOURce]:LFOutput<ch>:SHAPE:TRIangle:PERiod <Period>

The command sets the period of the generated pulse. The period determines the repetition frequency of the internal signal.

Parameters:

<Period> float
 Range: 1.0 μ s to 100.0 s
 Increment: 0.01 μ s
 *RST: 1 ms

Example:

SOUR:LFO2:SHAP:TRIA:PER 100s
 sets a pulse period of 100 s for the pulse shape of the signal of LF generator 2.

Options:

R&S SMF-B20

[[:SOURce]:LFOutput<ch>:SHAPE:TRIangle:RISE <Rise>

The command selects the rise time for the triangle shape of the LF generator.

Parameters:

<Rise> float
 Range: 1.0 μ s to 100.0 s
 Increment: 0.1 ns
 *RST: 0.5 ms

Example:

SOUR:LFO1:SHAP:TRI:RISE 13s
 selects a rise time of 13 s for triangle shape of the signal of LF generator 1.

Options:

R&S SMF-B20

[:SOURce]:LFOOutput<ch>:VOLTage <Voltage>

The command sets the output voltage of the LF output.

Parameters:

<Voltage> float
 Range: 0 to 5
 *RST: 1 V

Example:

SOUR:LFO1:VOLT 3V
 sets the voltage of the LF output to 3 V.

Options:

R&S SMF-B20

[:SOURce]:LFOOutput:VOLTage:MANual <Manual>

In Sweep mode (:SOUR:LFO:VOLT:MODE SWE) the command sets the level for the next sweep step in the "Step" sweep mode (:SOUR:LFO:SWE:VOLT:MODE MAN). Here only level values between the settings [:SOUR]:LFO:VOLT:STAR and ...:STOP are permitted. Each sweep step is triggered by a separate :SOUR:LFO:VOLT:MAN command.

As with the "Level" value entered in the "LF Level" dialog, the "OFFSet" value is also taken into consideration with this command.

The specified value range is therefore only effective if :SOURce:POWer:OFFSet is set to 0. The value range for other "OFFSet" values can be calculated using the following formula:

Minimum level + OFFSet ... Maximum level + OFFSet

Parameters:

<Manual> float

Minimum level ... Maximum level

The value range for the level setting varies according to the instrument model. The values are given in the data sheet.

Range: 0 to 6

Example: `SOUR:LFO:SWE:VOLT:MODE MAN`
 sets the Step sweep mode.
 `SOUR:LFO:VOLT:MAN -5dBm`
 sets an RF level of -5 dBm for the next setting in the Step sweep mode.
 `SOUR:LFO:VOLT:MODE SWE`
 sets the Level Sweep mode.
 `SOUR:LFO:VOLT:MAN -5.5dBm`
 triggers the next sweep step with a level of -5.5 dBm.

Options: R&S SMF-B20

[[:SOURce]:LFOOutput:VOLTage:MODE <Mode>

The command sets the instrument operating mode and therefore also the commands used to set the LF output level.

Parameters:

<Mode>

CW | SWEep

CW

The instrument operates at a constant level. The output level is set with `:SOURce:LFOOutput:POWer`.

SWEep

The instrument operates in SWEep mode. The level is set using the commands `SOURce:LFOOutput:POWer:STARt; STOP; MANual`.

*RST: CW

Example:

`SOUR:LFO:VOLT:MODE SWE`

sets the SWEep mode. The settings under

`SOURce:LFOOutput:POW:STARt; STOP; MANual` become effective.

Options:

R&S SMF-B20

[[:SOURce]:LFOOutput:VOLTage:STARt <Start>

The command sets the LF start level in sweep mode.

As with the "Level" value entered in the "LF Level" dialog, the "OFFSet" value is also taken into consideration with this command.

The specified value range is therefore only effective

if `:SOURce:LFOOutput:Sweep:POWer:OFFSet` is set to 0. The value range for other "OFFSet" values can be calculated using the following formula:

Minimum level + OFFSet ...Maximum level + OFFSet

Parameters:

<Start> float

Minimum level ... Maximum level

The value range for the level setting varies according to the instrument model. The values are given in the data sheet.

Range: 0 to 6

Increment: 0.1 mV

*RST: 1

Example:

SOUR:LFO:VOLT:STAR 5V

sets the start level for the LF level sweep to 5 V.

Options:

R&S SMF-B20

[:SOURce]:LFOutput:VOLTage:STOP <Stop>

The command sets the stop level in LF sweep mode.

As with the "Level" value entered in the "LF Level" menu, the "OFFSet" value is also taken into consideration with this command.

The specified value range is therefore only effective

if :SOURce:LFOutput:SWEep:POWer:OFFSet is set to 0. The value range for other "OFFSet" values can be calculated using the following formula:

$$\text{Minimum level} + \text{OFFSet} \dots \text{Maximum level} + \text{OFFSet}$$
Parameters:

<Stop> float

Minimum level ... Maximum level

The value range for the level setting varies according to the instrument model. The values are given in the data sheet.

Range: 0 to 6

Increment: 0.1 mV

*RST: 1 V

Example:

SOUR:LFO:VOLT:STOP 6V

sets the stop level for the LF level sweep to 6 V.

Options:

R&S SMF-B20

7.12.9 SOURce:LIST Subsystem

This subsystem contains the commands for the List mode of the instrument.

The following settings are required to operate the instrument in List mode:

1. Create a list.

If a list which does not exist is selected with the :LIST:SEL command, an empty list with the name of the selected list is created.

```
SOURce1:LIST:SEL "New_list"
```

2. Fill the list with values.
All list components must be of the same length. This does not apply to components of length 1. This is interpreted as if the component has the same length as the other components and as if all values are the same as the first value.
SOURce1:LIST:FREQ 100 MHz, 110 MHz, 120 MHz...
SOURce1:LIST:POW 2dBm, -1dBm, 0dBm...
3. Select a list.
If a new empty file has been created with the :LIST:SEL command, this file is selected, otherwise an existing list must be selected before the List mode is activated.
SOURce1:LIST:SEL "Old_list"
4. Set the dwell time.
The dwell time determines the duration of the individual list steps.
SOURce1:LIST:DWELL 3ms
5. Set the List mode.
The List mode determines the way in which the list is processed. In the example the list is processed once only or repeatedly depending on the trigger setting.
SOURce1:LIST:MODE AUTO
6. Determine the trigger.
In the example each trigger causes the list to be processed once from beginning to end.
SOURce:LIST:TRIGger:SOURce SINGLE
7. Activate the List mode.
SOURce1:FREQuency:MODE LIST
8. Trigger the list (depending on the mode).
SOURce1:LIST:TRIGger:EXECute
9. Deactivate the List mode.
SOURce1:FREQuency:MODE CW



SCPI refers to the individual lists as segments.

[SOURce<hw>]:LIST:CATalog.....	443
[SOURce<hw>]:LIST:DELeTe.....	443
[SOURce<hw>]:LIST:DELeTe:ALL.....	444
[SOURce<hw>]:LIST:DEXChange:AFILe:CATalog.....	444
[SOURce<hw>]:LIST:DEXChange:AFILe:EXTension.....	445
[SOURce<hw>]:LIST:DEXChange:AFILe:SELeCt.....	445
[SOURce<hw>]:LIST:DEXChange:AFILe:SEPARator:COLumn.....	446
[SOURce<hw>]:LIST:DEXChange:AFILe:SEPARator:DECimal.....	446
[SOURce<hw>]:LIST:DEXChange:EXECute.....	447
[SOURce<hw>]:LIST:DEXChange:MODE.....	447
[SOURce<hw>]:LIST:DEXChange:SELeCt.....	448
[SOURce<hw>]:LIST:DWELL.....	448

<code>[:SOURce<hw>]:LIST:FREE</code>	449
<code>[:SOURce<hw>]:LIST:FREQuency</code>	449
<code>[:SOURce<hw>]:LIST:FREQuency:POINts</code>	449
<code>[:SOURce<hw>]:LIST:INDex</code>	450
<code>[:SOURce<hw>]:LIST:INDex:START</code>	450
<code>[:SOURce<hw>]:LIST:INDex:STOP</code>	451
<code>[:SOURce<hw>]:LIST:LEARn</code>	451
<code>[:SOURce<hw>]:LIST:MODE</code>	451
<code>[:SOURce<hw>]:LIST:POWer</code>	452
<code>[:SOURce<hw>]:LIST:POWer:AMODE</code>	452
<code>[:SOURce<hw>]:LIST:POWer:POINts</code>	453
<code>[:SOURce<hw>]:LIST:RESet</code>	453
<code>[:SOURce<hw>]:LIST:SElect</code>	453
<code>[:SOURce<hw>]:LIST:TRIGger:EXECute</code>	454
<code>[:SOURce<hw>]:LIST:TRIGger:SOURce</code>	454

`[:SOURce<hw>]:LIST:CATalog?`

The command requests a list of available lists. The individual lists are separated by commas.

The lists are stored with the fixed file extensions `*.lsw` in a directory of the user's choice. The directory applicable to the commands is defined with the command `MMEMoRY:CDIR`.

Return values:

<Catalog> string

Example:

```
MMEM:CDIR '/var//Lists/Listmode'
selects the directory for the list mode files.
LIST:CAT?
queries the available lists.
Response: 'list1,list2'
the lists list1 and list2 are available.
```

Usage: Query only

`[:SOURce<hw>]:LIST:DELeTe <Delete>`

The command deletes the specified list.

The files are stored with the fixed file extensions `*.lsw` in a directory of the user's choice. The directory applicable to the command is defined with the command `MMEMoRY:CDIR`. To access the files in this directory, only the file name has to be given, without the path and the file extension. A path can also be specified in command `:SOUR:LIST:CAT?`, in which case the file in the specified directory is deleted.

*RST does not affect data lists.

Setting parameters:

<Delete> <list file name>

Example: MMEM:CDIR '/var//Lists/Listmode'
 selects the directory for the list mode files.
 LIST:DEL 'LIST1'
 deletes the list list1.

Usage: Setting only

[[:SOURce<hw>]:LIST:DELeTe:ALL

The command deletes all lists in the set directory. The List mode must be deactivated beforehand to ensure that no lists are selected when this command is called (SOUR:FREQ:MODE CW or SWE).

The files are stored with the fixed file extensions *.lsw in a directory of the user's choice. The directory applicable to the command is defined with the command MMEMoRY:CDIR. A path can also be specified in command SOUR:LIST:CAT?, in which case all list mode files in the specified directory are deleted.

*RST does not affect data lists.

Example: MMEM:CDIR '/var//Lists/Listmode'
 selects the directory for the list mode files.
 FREQ:MODE SWE
 deactivates the List mode for RF output and activates the Sweep mode.
 SOUR2:FREQ:MODE SWE
 deactivates the List mode for RF output and activates Sweep mode.
 LIST:DEL:ALL
 deletes all list mode files available in the set directory.

Usage: Event

[[:SOURce<hw>]:LIST:DEXChange:AFILe:CATalog?

The command requests a list of available ASCII files for export/import of list mode data. The individual files are separated by commas.

The ASCII files are stored with the fixed file extensions *.txt or *.csv in a directory of the user's choice. The directory applicable to the commands is defined with the command MMEMoRY:CDIR.

Return values:
 <Catalog> string

Example: MMEM:CDIR '/var//lists/listmode/import'
 selects the directory for the ASCII files with frequency and level value pairs.
 LIST:DEXC:AFIL:EXT TXT
 selects that ASCII files with extension *.txt are listed.
 LIST:DEXC:AFIL:CAT?
 queries the available files with extension *.txt.
 Response: 'list1,list2'
 the ASCII files list1.txt and list2.txt are available.

Usage: Query only

[:SOURce<hw>]:LIST:DEXChange:AFIL:EXTension <Extension>

The command selects the file extension of the ASCII file to be imported or exported. Selection TXT (text file) or CSV (Excel file) is available.

Parameters:

<Extension> TXT | CSV
 *RST: TXT

Example: MMEM:CDIR '/var//lists/listmode/import'
 selects the directory for the ASCII files with frequency and level value pairs.
 LIST:DEXC:AFIL:EXT TXT
 selects that ASCII files with extension *.txt are listed.
 LIST:DEXC:AFIL:CAT?
 queries the available files with extension *.txt.
 Response: 'list1,list2'
 the ASCII files list1.txt and list2.txt are available.

[:SOURce<hw>]:LIST:DEXChange:AFIL:SElect <Select>

The command selects the ASCII file to be imported or exported.

The ASCII files are stored with the fixed file extensions *.txt or *.csv in a directory of the user's choice. The directory applicable to the commands is defined with the command MMEMory:CDIR. A path can also be specified in command SOUR:LIST:DEXC:AFIL:SEL, in which case the files are stored or loaded in the specified directory.

Parameters:

<Select> <ascii_file_name>

Example:

```
LIST:DEXC:MODE IMP
selects that ASCII files with frequency and level value pairs are
imported and transferred into list mode lists.
LIST:DEXC:AFIL:SEL
'/var//user/listmode/import/list.csv'
selects that ASCII file list.csv is imported.
LIST:DEXC:SEL
'/var//user/listmode/import/list_imp'
selects that the ASCII file list.csv is imported into list mode list
list_imp.
```

[:SOURce<hw>]:LIST:DEXChange:AFILe:SEParator:COLumn <Column>

The command selects the separator between the frequency and level column of the ASCII table.

Parameters:

<Column> TABulator | SEMicolon | COMMa | SPACE
 *RST: COMMa

Example:

```
LIST:DEXC:MODE EXP
selects that the list mode list is exported into an ASCII file.
LIST:DEXC:AFIL:SEL
'/var//user/listmode/import/list.csv'
selects ASCII file list.csv as destination for the list mode list
data.
LIST:DEXC:AFIL:SEP:COL TAB
the pairs of frequency and level values are separated by a tabu-
lator.
LIST:DEXC:AFIL:SEP:DEC DOT
selects the decimal separator dot.
LIST:DEXC:SEL
'/var//user/listmode/import/list_imp'
selects that the list mode list list_imp is imported into ASCII file
list.csv.
```

[:SOURce<hw>]:LIST:DEXChange:AFILe:SEParator:DECimal <Decimal>

The command the decimal separator used in the ASCII data between '.' (decimal point) and ',' (comma) with floating-point numerals.

Parameters:

<Decimal> DOT | COMMa
 *RST: DOT

Example:

```
LIST:DEXC:MODE EXP
selects that the list mode list is exported into an ASCII file.
LIST:DEXC:AFIL:SEL
'/var//user/listmode/import/list.csv'
selects ASCII file list.csv as destination for the list mode list
data.
LIST:DEXC:AFIL:SEP:COL TAB
the pairs of frequency and level values are separated by a tabu-
lator.
LIST:DEXC:AFIL:SEP:DEC DOT
selects the decimal separator dot.
LIST:DEXC:SEL
'root/var//user/listmode/import/list_imp'
selects that the list mode list list_imp is imported into ASCII file
list.csv.
```

[:SOURce<hw>]:LIST:DEXChange:EXECute

The command starts the export or import of the selected file. When import is selected, the ASCII file is imported as list mode list. When export is selected, the list mode list is exported into the selected ASCII file.

Example:

```
LIST:DEXC:MODE IMP
selects that ASCII files with frequency and level value pairs are
imported and transferred into list mode lists.
LIST:DEXC:AFIL:SEL
'/var//user/listmode/import/list.csv'
selects that ASCII file list.csv is imported.
LIST:DEXC:SEL
'/var//user/listmode/import/list_imp'
selects that the ASCII file list.csv is imported into list mode list
list_imp.
LIST:DEXC:EXEC
starts the import of the ASCII file data into the list mode file.
```

Usage: Event

[:SOURce<hw>]:LIST:DEXChange:MODE <Mode>

The command selects if list mode lists should be imported or exported. Depending on the selection here, the file select command defines either the source or the destination for list mode lists and ASCII files.

Parameters:

<Mode> IMPort | EXPort
*RST: IMPort

Example:

```
LIST:DEXC:MODE IMP
selects that ASCII files with frequency and level value pairs are
imported and transferred into list mode lists.
LIST:DEXC:AFIL:SEL
'/var//user/listmode/import/list.csv'
selects that ASCII file list.csv is imported.
LIST:DEXC:SEL
'root/var//user/listmode/import/list_imp'
selects that the ASCII file list.csv is imported into list mode list
list_imp.
```

[:SOURce<hw>]:LIST:DEXChange:SElect <Select>

The command selects the list mode list to be imported or exported.

The list mode files are stored with the fixed file extensions *.lsw in a directory of the user's choice. The directory applicable to the commands is defined with the command `MMEMory:CDIR`. A path can also be specified in command `SOUR:LIST:DEXC:SEL`, in which case the files are stored or loaded in the specified directory.

Parameters:

<Select> <list_name>

Example:

```
LIST:DEXC:MODE IMP
selects that ASCII files with frequency and level value pairs are
imported and transferred into list mode lists.
LIST:DEXC:AFIL:SEL
'/var//user/listmode/import/list.csv'
selects that ASCII file list.csv is imported.
LIST:DEXC:SEL
'/var//user/listmode/import/list_imp'
selects that the ASCII file list.csv is imported into list mode list
list_imp.
```

[:SOURce<hw>]:LIST:DWELI <Dwell>

The command sets the time for which the instrument retains a setting.

Parameters:

<Dwell> float
 Range: 0.5 ms to 100 s
 Increment: 1E-4
 *RST: 10.0 ms
 Default unit: s

Example:

```
LIST:DWEL 15
each setting in the list is retained for 15 ms.
```

[[:SOURce<hw>]:LIST:FREE?

This command queries on the free storage space for list mode lists.

Return values:

<Free> integer
 Range: 0 to INT_MAX
 Increment: 1
 *RST: 0

Example: LIST:FREE?

Usage: Query only

Response: 2147483647;1

[[:SOURce<hw>]:LIST:FREQUENCY <Frequency>

The command fills the FREQUENCY part of the selected list with data.

*RST does not affect data lists.

Parameters:

<Frequency> <Frequency#1>{, <Frequency#2>, ...} | block data
 The data can be given either as a list of numbers (list can be of any length and list entries must be separated by commas) or as binary block data. When block data is transferred, 8 (4) bytes are always interpreted as a floating-point number with double accuracy (see :FORMat [:DATA] on page 316).
 Range: 300 kHz to RFmax (RFmax depending on model)

Example: LIST:SEL '/var//Lists/Listmode/list3'
 selects list3 for editing. List3 is created if it does not yet exist.
 SOUR:LIST:FREQ 1.4GHz, 1.3GHz, 1.2GHz, ...
 specifies the frequency values in list3. If the list already contains data, it is overwritten.

Usage: SCPI confirmed

[[:SOURce<hw>]:LIST:FREQUENCY:POINTS?

The command queries the length (in points) of the FREQUENCY component of the selected list.

Return values:

<Points> float

Example: LIST:SEL '/var//Lists/Listmode/list3'
 selects list3 for editing. List3 is created if it does not yet exist.
 LIST:FREQ:POIN?
 queries the number of frequency values in list3.
 Response: 327
 list3 has 327 frequency entries.

Usage: Query only

[[:SOURce<hw>]:LIST:INDEX <Index>

The command sets the list index in step mode (LIST:MODE STEP).

After the trigger signal the frequency and level settings of the selected index are processed in List mode.

Parameters:

<Index> float
*RST: 0

Example:

```
LIST:SEL '/var//Lists/Listmode/list3'
```

selects list3 for use in List mode.

```
FREQ:MODE LIST
```

activates List mode. List3 is processed.

```
LIST:MODE STEP
```

selects manual, step-by-step processing of the list.

```
LIST:IND 5
```

the frequency/level value pair with index 5 is executed.

```
TRIG:LIST:SOUR SING
```

selects triggering by means of the single trigger. The list is executed once.

```
SOUR:LIST:TRIG:EXEC
```

triggers the processing of the selected list.

[[:SOURce<hw>]:LIST:INDEX:START <Start>

The command sets the start index of the index range which defines a subgroup of frequency/level value pairs in the current list. Only the values in the set index range (:LIST:INDEX:START ... :LIST:INDEX:STOP) are processed in List mode.

Parameters:

<Start> float
Range: 0 to list length
*RST: 0

Example:

```
LIST:SEL '/var//Lists/Listmode/list3'
```

selects list3 for use in List mode.

```
LIST:IND:STAR 25
```

sets 25 as start index of the index range.

```
LIST:IND:STOP 49
```

sets 49 as stop index of the index range.

```
FREQ:MODE LIST
```

activates List mode. The frequency/level value pairs from index 25 to index 49 in list3 are processed. All other entries of the list are ignored.

[[:SOURce<hw>]:LIST:INDEX:STOP <Stop>

The command sets the stop index of the index range which defines a subgroup of frequency/level value pairs in the current list. Only the values in the set index range (:LIST:INDEX:START ... :LIST:INDEX:STOP) are processed in List mode.

Parameters:

<Stop> float
 Range: 0 to list length
 *RST: 0

Example:

```
LIST:SEL '/var//Lists/Listmode/list3'
selects list3 for use in List mode.
LIST:IND:STAR 25
sets 25 as start index of the index range.
LIST:IND:STOP 49
sets 49 as stop index of the index range.
FREQ:MODE LIST
activates List mode. The frequency/level value pairs from index 25
to index 49 in list3 are processed. All other entries of the list are
ignored.
```

[[:SOURce<hw>]:LIST:LEARn

The command learns the selected list, i.e. it determines the hardware setting for the entire list. The data determined in this way is stored together with the list. When the list is activated for the first time, these settings are calculated automatically.

Example:

```
LIST:SEL '/var//Lists/Listmode/list3'
selects list3. List3 is created if it does not yet exist.
LIST:LEAR
starts learning of the hardware setting for list3 and stores the set-
ting.
```

Usage: Event

[[:SOURce<hw>]:LIST:MODE <Mode>

The command specifies how the list is to be processed (similar to SOURce:SWEep:MODE).

Parameters:

<Mode> AUTO | STEP

AUTO

Each trigger event triggers a complete list cycle. Possible trigger settings for :LIST:TRIGger:SOURce are AUTO, SINGLE and EXT.

STEP

Each trigger event triggers only one step in the list processing cycle. The list is processed in ascending order.

*RST: AUTO

Example:

```
LIST:MODE STEP
selects step-by-step processing of the list.
```

Usage:

SCPI confirmed

[:SOURce<hw>]:LIST:POWer <Power>

The command fills the Level part of the selected list with data.

*RST does not affect data lists.

Parameters:

<Power> <Power#1>{, <Power#2>, ...} | block data

The data can be given either as a list of numbers (list can be of any length and list entries must be separated by commas) or as binary block data. When block data is transferred, 8 (4) bytes are always interpreted as a floating-point number with double accuracy (see :FORMat[:DATA] on page 316).

Range: Minimum level to Maximum level

Default unit: dBm

Example:

```
LIST:SEL '/var//Lists/Listmode/list3'
selects list3 for editing. List3 is created if it does not yet exist.
LIST:POW 0dBm, 2dBm, 2dBm, 3dBm, ..
specifies the level values in list3. The number of level values
must correspond to the number of frequency values. The previous
data is overwritten.
```

Usage:

SCPI confirmed

[:SOURce<hw>]:LIST:POWer:AMODE <Amode>

The command selects the ranges of level settings for the list mode. The level settings are either performed in the low level or in the high level ranges.

Parameters:

<Amode> NORMal | HPOWer

NORMal

The level settings are made in the range of the electronically switching attenuator. The high level ranges are not available.

HPOWer

The level settings are made in the range of the option. Only the high level range is available.

*RST: NORMal

Example:

```
LIST:POW:AMOD HPOW
selects the high level ranges for List Mode.
```

[[:SOURce<hw>]:LIST:POWer:POINts?

The command queries the length (in points) of the LEVel part of the selected list.

Return values:

<points> float

Example:

```
LIST:SEL '/var//Lists/Listmode/list3'
selects list3 for editing. List3 is created if it does not yet exist.
LIST:POW:POIN?
queries the number of levels in list3.
Response: 327
LIST2 has 327 level entries.
```

Usage:

Query only
SCPI confirmed

[[:SOURce<hw>]:LIST:RESet

The command resets the list to the starting point.

Example:

```
LIST:RES
resets the list to the starting point.
```

Usage:

Event

[[:SOURce<hw>]:LIST:SElect <Select>

The command selects the specified list. If a new list is to be created, the name can be entered here. The list is created if it does not yet exist. The list selected here is available for the further processing steps (editing) and is used in the instrument when the List mode is activated.

The files are stored with the fixed file extensions *.lsw in a directory of the user's choice. The directory applicable to the command is defined with the command `MMEMory:CDIR`. A path can also be specified in command `:SOUR:LIST:SEL` in which case the list mode file in the specified directory is selected.

*RST does not affect data lists.

Parameters:

<Select> '<list name>'

Example:

```
LIST:SEL '/var//Lists/Listmode/list3'
```

selects list3 for editing. List3 is created if it does not yet exist.

[:SOURce<hw>]:LIST:TRIGger:EXECute

The command immediately starts the processing of a list in list mode. It corresponds to the manual-control command "Execute Single."

Example:

```
SOUR:LIST:TRIG:EXEC
```

triggers the processing of the selected list.

Usage:

Event

[:SOURce<hw>]:LIST:TRIGger:SOURce <Source>

The command sets the trigger source for the LIST mode.

The names of the parameters correspond to those under sweep mode. SCPI uses other names for the parameters; these names are also accepted by the instrument. The SCPI names should be used if compatibility is an important consideration. An overview of the various names is given in the following table:

R&S name	SCPI name	Command under manual control
AUTO	IMMediate	MODE AUTO
SINGle	BUS	MODE SINGLE or STEP
EXTernal	EXTernal	MODE EXT TRIG SINGLE or EXT TRIG STEP

Parameters:

<Source>

AUTO | IMMediate | SINGle | BUS | EXTernal

AUTO|IMMediate

The trigger is free-running, i.e. the trigger condition is fulfilled continuously. The selected list in List mode is restarted as soon as it is finished.

SINGle|BUS

The list is triggered by the GPIB commands `[:SOURce<hw>] :LIST:TRIGger:EXECute`. The list is executed once.

EXTernal

The list is triggered externally via the INST TRIG connector. The list is executed once.

*RST: SINGle

Example:

```
LIST:TRIG:SOUR EXT
```

selects triggering by means of the external trigger.

7.12.10 SOURce:MODulation Subsystem

This subsystem contains the command for switching on/off all modulations.

[:SOURce<hw>]:MODulation[:ALL]:STATe <State>

The command switches the modulations on and off.

The command `SOUR:MOD:ALL:STAT OFF` switches all modulations off. A subsequent command `SOUR:MOD:ALL:STAT ON` restores the status that was active before the last switch-off. "MOD OFF" is displayed in the info line of the header next to the "Level" field.

Parameters:

<State> 0 | 1 | OFF | ON

Example:

`MOD:STAT OFF`
switches off all modulations.

7.12.11 SOURce:NOISe Subsystem

The `SOURce:NOISe` subsystem contains the commands for setting the noise modulation signal. The noise generator is optional.

<code>[:SOURce<hw>]:NOISe:BWIDth</code>	455
<code>[:SOURce<hw>]:NOISe:DISTRibution</code>	455
<code>[:SOURce<hw>]:NOISe:LEVel:RELative</code>	456
<code>[:SOURce<hw>]:NOISe:LEVel[:ABSolute]</code>	456

[:SOURce<hw>]:NOISe:BWIDth <Bwidth>

This command sets the noise level in the system bandwidth for enabled bandwidth limitation. Distinct bandwidth settings between 10 kHz and 10 MHz in 100 kHz steps (range 100 .. 1 MHz), 1 MHz (range 1 MHz .. 5 MHz) and 5 MHz (5 MHz ... 10 MHz) are possible.

Parameters:

<Bwidth> float
Range: 100 kHz to 10 MHz
Increment: 100 kHz
*RST: 100 kHz

Example:

`NOIS:BWID:STAT ON`
enables bandwidth limitation.
`NOIS:BWID 1 MHz`
sets a system bandwidth of 1 MHz.

Options: R&S SMF-B20

[:SOURce<hw>]:NOISe:DISTRibution <Distribution>

Selects the noise power density distribution of the noise.

Parameters:

<Distribution> GAUSSs | EQUal
 *RST: GAUSSs

Example:

NOIS:DIST GAUS ON
 selects Gaussian distribution.

Options:

R&S SMF-B20

[[:SOURce<hw>]:NOISe:LEVel:RELative?]

This command queries the level of the noise signal per Hz in the total bandwidth.

Return values:

<Relative> float

Example:

NOIS:LEV:REL?
 queries the noise level

Usage:

Query only

Options:

R&S SMF-B20

[[:SOURce<hw>]:NOISe:LEVel[:ABSolute]?

This command queries the level of the noise signal in the system bandwidth for enabled bandwidth limitation.

Return values:

<Absolute> float

Example:

NOIS:BWID:STAT ON
 enables bandwidth limitation.
 NOIS:BWID 10 MHz
 sets a system bandwidth of 1 MHz.
 NOIS:LEV:ABS
 queries the noise level in the system bandwidth

Usage:

Query only

Options:

R&S SMF-B20

7.12.12 SOURce:PGEN Subsystem

This subsystem contains the commands for setting the pulse generator.

[:SOURce<hw>]:PGEN:OUTPut:POLarity	456
[:SOURce<hw>]:PGEN:OUTPut[:STATe]	457

[[:SOURce<hw>]:PGEN:OUTPut:POLarity <Polarity>

The command sets the polarity between modulating and modulated signal. This command is effective only for an internal modulation signal.

Parameters:

<Polarity> NORMal | INVerted

NORMal

The RF signal is suppressed during the pulse pause.

INVerted

The RF signal is suppressed during the pulse.

Example:

PGEN:OUTP:POL INV
selects inverted polarity.

Options:

R&S SMF-K23

[:SOURce<hw>]:PGEN:OUTPut[:STATe] <State>

The command activates/deactivates the pulse generator output.

Parameters:

<State> 0 | 1 | OFF | ON
*RST: OFF

Example:

PGEN:OUTP ON
activates pulse generator output.

Options:

R&S SMF-K23

7.12.13 SOURce:PHASe Subsystem

This subsystem contains the commands for adjusting the phase of the RF output signal relative to a reference signal of the same frequency.

[:SOURce<hw>]:PHASe.....	457
[:SOURce<hw>]:PHASe:REFerence.....	458

[:SOURce<hw>]:PHASe <Phase>

The command specifies the phase variation relative to the current phase. The variation can be specified in RADians.

Parameters:

<Phase> float
Range: -359.9 to 359.9
Increment: 0.1 deg
*RST: 0.0 deg

Example:

PHAS 2DEG
changes the phase by 2 degrees relative to the current phase.
PHAS:REF
adopts the set phase as the current phase.

Usage:

SCPI confirmed

[[:SOURce<hw>]:PHASe:REFerence

The command adopts the phase set with `SOURce:PHASe:ADJust` as the current phase.

Example: `PHAS 0.1RAD`
 changes the phase by 0.1 RAD relative to the current phase.
 `PHAS:REF`
 adopts the set phase as the current phase.

Usage: Event
 SCPI confirmed

7.12.14 SOURce:PM Subsystem

The PM subsystem contains the commands for checking the phase modulation. The settings for the internal modulation source (LF generator) are made in the [SOURce:LFOuTput](#) subsystem.

The external signal is input at the EXT1 and EXT2 connector.

For information about the required options, see [chapter 5.5.4, "Phase Modulation \(PhiM\)"](#), on page 223.

[:SOURce]:PM<ch>[:DEViation]	458
[:SOURce<hw>]:PM:MODE	458
[:SOURce<hw>]:PM:RATio	459
[:SOURce<hw>]:PM<ch>:SOURce	459
[:SOURce<hw>]:PM<ch>:STATe	460

[[:SOURce]:PM<ch>[:DEViation] <Deviation>

Sets the modulation deviation in RAD or degrees.

Parameters:

<Deviation> float
 Range: 0 rad to 320 rad

Example: `PM1:DEV 20RAD`
 selects a deviation of 20 RAD for the selected modulation source for path 1.

Options: R&S SMF-B20

[[:SOURce<hw>]:PM:MODE <Mode>

The command selects the mode for the phase modulation.

Parameters:

<Mode> HBANdwidth | HDEVIation | LNOise

HBANdwidth

The maximum range for modulation bandwidth is available. However, phase noise is increased for low frequencies. The range for PhiM deviation is limited. This mode is recommended for high modulation frequencies.

HDEVIation

The maximum range for PhiM deviation is available. Phase noise is improved for low frequencies. The range for modulation frequency is limited (see data sheet). This mode is recommended for low modulation frequencies and/or high PhiM deviation.

LNOise

Phase modulation with phase noise and spurious characteristics close to CW mode. The range for modulation bandwidth and PM deviation is limited (see data sheet)

*RST: HBANdwidth

Example:

```
PM:MODE LNO
selects Low Noise mode for external phase modulation.
```

Usage:

SCPI confirmed

Options:

R&S SMF-B20

[:SOURce<hw>]:PM:RATio <Ratio>

The command sets the path 1/path 2 ratio in percent.

Parameters:

<Ratio> float
 Range: 0 to 100
 Increment: 0.01
 *RST: EXT1

Example:

```
PM:RAT 50PCT
sets the path 1/path 2 ratio to 50 percent.
```

Options:

R&S SMF-B20

[:SOURce<hw>]:PM<ch>:SOURce <Source>

Selects the source for the phase modulation signal.

Parameters:

<Source> LF1 | LF2 | NOISe | EXT1 | EXT2
 *RST: EXT1

Example:

```
PM1:SOUR LF2
selects the LF generator 2 as internal modulation source for path 1.
```

Options: R&S SMF-B20

[:SOURce<hw>]:PM<ch>:STATe <State>

The command activates/deactivates phase modulation.

Activation of phase modulation deactivates frequency modulation.

Parameters:

<State> 0 | 1 | OFF | ON

Example:

PM1:STAT ON
activates PM modulation for path 1.

Options: R&S SMF-B20

7.12.15 SOURce:POWer Subsystem

This subsystem contains the commands for setting the output level, level control and level correction of the RF signal.

Other units can also be used instead of dBm:

- by entering the unit directly after the numerical value (example :POW 0.5V)
- by changing the DEFault unit in the UNIT system (see the command :UNIT:POWer).

[:SOURce<hw>]:POWer:ALC:PMETer:TYPE	460
[:SOURce<hw>]:POWer:ALC:REFerence	461
[:SOURce<hw>]:POWer:ALC:SONCe	461
[:SOURce<hw>]:POWer:ALC:SOURce	461
[:SOURce<hw>]:POWer:ALC[:STATe]	462
[:SOURce<hw>]:POWer:ATTenuation:RFOff:MODE	462
[:SOURce]:POWer:ATTenuation	462
[:SOURce<hw>]:POWer[:LEVel][:IMMediate][:AMPLitude]	463
[:SOURce<hw>]:POWer[:LEVel][:IMMediate]:OFFSet	463
[:SOURce<hw>]:POWer[:LEVel][:IMMediate]:RCL	464
[:SOURce<hw>]:POWer:LIMit[:AMPLitude]	464
[:SOURce<hw>]:POWer:MANual	465
[:SOURce<hw>]:POWer:MODE	466
[:SOURce<hw>]:POWer:POWer	466
[:SOURce<hw>]:POWer:RESolution	467
[:SOURce<hw>]:POWer:STARt	467
[:SOURce<hw>]:POWer:STEP[:INCRement]	468
[:SOURce<hw>]:POWer:STEP:MODE	468
[:SOURce<hw>]:POWer:STOP	468

[:SOURce<hw>]:POWer:ALC:PMETer:TYPE <Type>

The command selects the power meter used for external level control.

Parameters:

<Type> NRP | NRVD | HP436 | HP437 | HP438 | ML2438 | P44X
 *RST: NRP

Example:

POW:ALC:PMET:TYPE HP438
 the specified power meter is used for external level control.

[:SOURce<hw>]:POWER:ALC:REFerence <Reference>

The command sets the reference voltage for external power control. See specification of the used instrument for external power control for details.

Parameters:

<Reference> float
 Range: 0.0 to 2.5
 *RST: 1.5

Example:

SOUR:POW:ALC:REF 0.37
 sets a reference voltage of 0.37 volt.

[:SOURce<hw>]:POWER:ALC:SONCe

The command briefly activates level control for correction purposes.

Example:

POW:ALC OFF
 deactivates automatic level control for RF output A.
 POW:ALC:SONC
 level control is performed once only.

Usage:

Event

[:SOURce<hw>]:POWER:ALC:SOURce <Source>

The command selects the detector for level control.

Parameters:

<Source> INTernal | DIODe | PMETer

INTernal

The internal detector is switched on.

DIODe

A diode detector can be connected to the EXT ALC input.

PMETer

A power meter can be connected to the EXT ALC input.

*RST: INT

Example:

POW:ALC:SOUR INT
 sets the internal detector for level control.

```
[ :SOURce<hw>]:POWER:ALC[:STATe] <State>
```

The command activates/deactivates automatic level control.

Parameters:

```
<State>          ON | OFF
```

ON
Internal level control is permanently activated. This provides the highest level accuracy.

OFF
Internal level control is deactivated, **Sample & Hold** mode is activated.

```
*RST:          ON
```

Example:

```
POW:ALC ON
activates internal level control.
```

```
[ :SOURce<hw>]:POWER:ATTenuation:RFOff:MODE <Mode>
```

The command selects the mode of the mechanical attenuator, when the RF signal is switched off.

The setting of the RF OFF mode is not affected by an instrument preset (PRESET key), *RST and the "Save/Recall" function. This parameter is influenced only by the [Factory Preset](#).

Parameters:

```
<Mode>          NORMal | ATTenuated
```

NORMal
The current attenuation remains when the RF signal is switched off and thus provides fast and wear-free operation.

ATTenuated
The attenuation is set to maximum when the RF signal is switched off. This setting is recommended for applications that require a high level of noise suppression.

```
*RST:          NORMal
```

Example:

```
SOUR:POW:ATT:RFOFF:MODE ATT
sets the RF OFF attenuator to maximum.
```

Options:

```
R&S SMF-B26 or R&S SMF-B27
```

```
[ :SOURce]:POWER:ATTenuation <Attenuation>
```

The command sets the attenuation.

Parameters:

```
<Attenuation>   float
```

```
Range:          0.0 to 110.0
```

```
*RST:          0
```

Example: `SOUR:POW:ATT 20dB`
sets the power attenuation to 20 dB.

[[:SOURce<hw>]:POWer[:LEVel][:IMMediate][:AMPLitude] <Amplitude>

The command sets the RF output level in CW mode. In addition to numerical values, it is also possible to specify `UP` and `DOWN`. The level is then increased or decreased by the value specified under `[SOURce<hw>:]POWer:STEP`.

As with the **Level** value entered in the header, the `OFFSet` value is also taken into consideration with this command.

The specified value range is therefore only effective if `:SOURce:POWer:OFFSet` is set to 0. The value range for other `OFFSet` values can be calculated using the following formula:

Minimum level + `OFFSet` ... Maximum level + `OFFSet`

The keywords of this command are largely optional. Therefore, both the long and short form of the command are shown in the example.

Parameters:

<Amplitude>

Minimum level ... Maximum level

The value range for the level setting varies according to the instrument model.

The values are given in the data sheet.

Increment: 0.01 dB

*RST: -30 dBm

Default unit: dBm

Example: `SOUR:POW:LEV:IMM:AMPL 15`
or
`:POW 15`
sets the RF level at output A to 15 dBm.

Usage: SCPI confirmed

[[:SOURce<hw>]:POWer[:LEVel][:IMMediate]:OFFSet <Offset>

Note: The level offset is also effective for level sweeps!

The command specifies the constant level offset of a downstream attenuator/amplifier. If a level offset is entered, the level entered with `:POWer` no longer corresponds to the RF output level.

The following correlation applies:

`:POWer` = RF output level + `POWer:OFFSet`.

Entering a level offset does not change the RF output level, but rather the query value of `:POWer`.

For more information, see [chapter 5.4.1.1, "RF level vs. RF output level"](#), on page 149.

Only dB is permitted as the unit here. The linear units (V, W, etc.) are not permitted.

The keywords of this command are largely optional. Therefore, both the long and short form of the command are shown in the example.

Parameters:

<Offset> float
 Range: -100 dB to 100 dB
 Increment: 0.01 dB
 *RST: 0 dB
 Default unit: dB

Example:

SOURce:POWer:LEVel:IMMediate:OFFSet -10
 or
 POW:OFFS 10
 sets the RF level offset to 10 dB

Usage: SCPI confirmed

[:SOURce<hw>]:POWer[:LEVel][:IMMediate]:RCL <Rcl>

The command determines whether the current level is retained or whether the stored level setting is adopted when an instrument configuration is loaded.

*RST does not affect this setting.

Parameters:

<Rcl> INCLude | EXCLude
INCLude
 The stored level is also loaded when a stored instrument configuration is loaded.
EXCLude
 The RF level is not loaded when a stored instrument configuration is loaded. The current level is retained.
 *RST: no default

Example:

POW:RCL INCL
 the stored level is set if the Recall command is called.

Usage: SCPI confirmed

[:SOURce<hw>]:POWer:LIMit[:AMPLitude] <Amplitude>

The command limits the maximum RF output level in CW and SWEEP mode. It does not influence the "Level" display or the response to the POW? query command.

The value is not affected by an instrument preset (PRESET key), *RST and the Save/Recall function. This parameter is influenced only by the factory preset (SYST:FPR) and its factory value is equal to the upper limit.

Parameters:

<Amplitude>

float

Minimum level ... Maximum level

The value range for the level setting varies according to the instrument model.

The values are given in the data sheet.

Increment: 0.01 dB

*RST: 30 dBm

Default unit: dBm

Example:

```
SOURce:POWer:LIMit:AMPLitude 10
```

or

```
:POW:LIM 10
```

limits the RF level to maximum +10 dBm.

Usage:

SCPI confirmed

[[:SOURce<hw>]:POWer:MANual <Manual>

In Sweep mode (:SOUR:POW:MODE SWE) the command sets the level for the next sweep step in the Step sweep mode (:SOUR:SWE:POW:MODE MAN). Here only level values between the settings [:SOUR]:POW:STAR and [:SOUR]:POW:STOP are permitted. Each sweep step is triggered by a separate :SOUR:POW:MAN command.

As with the "Level" value entered in the "RF Level" menu, the OFFSet value is also taken into consideration with this command.

The specified value range is therefore only effective if :SOURce:POWer:OFFSet is set to 0. The value range for other OFFset values can be calculated using the following formula:

Minimum level + OFFSet ... Maximum level + OFFSet

Parameters:

<Manual>

float

Minimum level ... Maximum level

The value range for the level setting varies according to the instrument model

The values are given in the data sheet.

Increment: 0.01 dBm

*RST: -30 dBm

Default unit: dBm

Example:

```
POW:SWE:MODE MAN
sets the Step sweep mode for RF output A.
POW:MAN -5 dBm
sets an RF level of -5 dBm for the next setting in the Step sweep
mode for RF output A.
POW:MODE SWE
sets the Level Sweep mode for RF output A.
POW:MAN -5.5 dBm
triggers the next sweep step with a level of -5.5 dBm.
```

Usage: SCPI confirmed

[:SOURce<hw>]:POWER:MODE <Mode>

The command sets the instrument operating mode and therefore also the commands used to set the output level.

Parameters:

<Mode>

CW | FIXed | SWEep

CW|FIXed

The instrument operates at a constant level. CW and FIXed are synonyms. The output level is set with :SOURce:POWer.

SWEep

The instrument operates in SWEep mode.

The level is set using the commands SOURce:POWer:START; STOP; MANual.

LIST

The instrument processes a list of frequency and level settings. The List mode settings are made in the [SOURce:LIST Subsystem](#) subsystem.

The setting SOURce:POWer:MODE LIST also sets the command SOURce:FREQuency:MODE automatically to LIST.

*RST: CW

Example:

```
POW:MODE SWEep
sets the SWEep mode. The settings under SOURce:POW:START;
STOP; MANual become effective.
```

Usage:

SCPI confirmed

[:SOURce<hw>]:POWER:POWER <Power>

Sets the RF level of the RF output connector.

The level entered with this command corresponds to the level at the RF output, i.e. any offset entry is not taken into consideration.

Note: The SCPI command [:SOURce<hw>]:POWER[:LEVel][:IMMediate][:AMPLitude] sets the level of the the "Level" display, i.e. the level containing offset.

Parameters:

<Power> Minimum level ... Maximum level
 The value range for the level setting varies according to the instrument model.
 The values are given in the data sheet.
 Increment: 0.01 dB
 *RST: -30 dBm
 Default unit: dBm

Example:

SOUR:POW:POW 15
 sets the RF level at output to 15 dBm.

[[:SOURce<hw>]:POWer:RESolution <Resolution>

The command selects the resolution for the level settings.

Parameters:

<Resolution> R01 | R1
 *RST: R01

Example:

POW:RES R01
 sets the resolution for the level settings to 0.01 dB.

[[:SOURce<hw>]:POWer:STARt <Start>

The command sets the RF start level in Sweep mode.

As with the "Level" value entered in the "RF Level" menu, the `OFFSet` value is also taken into consideration with this command.

The specified value range is therefore only effective if `:SOURce:POWer:OFFSet` is set to 0. The value range for other `OFFSet` values can be calculated using the following formula:

Minimum level + `OFFSet` ... Maximum level + `OFFSet`

Parameters:

<Start> float
Minimum level ... Maximum level
 The value range for the level setting varies according to the instrument model. The values are given in the data sheet.
 Increment: 0.01 dB
 *RST: -30 dBm
 Default unit: dBm

Example:

POW:STAR -20 dBm
 sets the start level for the level sweep to -15 dBm for RF output A.

Usage:

SCPI confirmed

[[:SOURce<hw>]:POWER:STEP[:INCRement] <Increment>

The command sets the step width for the level setting if UP and DOWN are used as the level values and variation mode :SOUR:POW:STEP:MODE USER is selected. The command is linked to setting "Variation Step" for manual control, i.e. the command also sets the step width of the rotary knob for "Variation Active On".

Parameters:

<Increment> float
 Range: 0 dB to 100 dB
 Increment: 0.01 dB
 *RST: 1 dB
 Default unit: dB

Example:

```
SOURce:POWer:STEP:INCRement 2
```

or

```
POW:STEP 2
```

sets the step width for entering the RF level to 2 dB.

[[:SOURce<hw>]:POWER:STEP:MODE <Mode>

This command activates (USER) or deactivates (DECimal) the user-defined step width used when varying the level value with the level values UP/DOWN. The command is linked to setting "Variation Active" for manual control, i.e. the command also activates/deactivates the user-defined step width used when varying the level value with the rotary knob.

Parameters:

<Mode> DECimal | USER
 *RST: DECimal

Example:

```
POW:STEP 2
```

sets the step width for the level setting to 2 dB.

```
POW:STEP:MODE USER
```

activates this step width for level variation with the rotary knob (manual control) and with level values UP/DOWN (remote control).

[[:SOURce<hw>]:POWER:STOP <Stop>

The command sets the stop level in Sweep mode.

As with the **Level** value entered in the **RF Level** menu, the OFFSet value is also taken into consideration with this command.

The specified value range is therefore only effective if :SOURce:POWer:OFFSet is set to 0. The value range for other OFFset values can be calculated using the following formula:

Minimum level + OFFSet ... Maximum level + OFFSet

Parameters:

<Stop>

float

Minimum level ... Maximum level

The value range for the level setting varies according to the instrument model.

The values are given in the data sheet.

Increment: 0.01 dB

*RST: -10 dBm

Default unit: dBm

Example:

POW:STOP 3

sets the stop level for the level sweep to 3 dBm for RF output A.

Usage:

SCPI confirmed

7.12.16 SOURce:PULM Subsystem

This subsystem contains the commands for setting the pulse modulation.

The LF generator is used as the internal modulation source. The pulse frequency of the internal rectangular signal is therefore set in the `SOURce:LFOutput` subsystem.

The external signal is input at the PULSE IN connector. The connector can be used as trigger input for internal pulse modulation. The polarity and input impedance of the connector can be selected. The pulse modulation signal is output at the PULSE OUT connector.

<code>[SOURce<hw>]:PULM:DElAy</code>	470
<code>[SOURce<hw>]:PULM:DOUBle:DElAy</code>	470
<code>[SOURce<hw>]:PULM:DOUBle:STATe</code>	470
<code>[SOURce<hw>]:PULM:DOUBle:WIDTh</code>	471
<code>[SOURce<hw>]:PULM:MODE</code>	471
<code>[SOURce<hw>]:PULM:OUTPut:VIDeo:POLarity</code>	471
<code>[SOURce<hw>]:PULM:PERiod</code>	472
<code>[SOURce<hw>]:PULM:POLarity</code>	472
<code>[SOURce<hw>]:PULM:SOURce</code>	473
<code>[SOURce<hw>]:PULM:STATe</code>	473
<code>[SOURce<hw>]:PULM:SYNC</code>	473
<code>[SOURce<hw>]:PULM:TRAIIn:CATalog</code>	474
<code>[SOURce<hw>]:PULM:TRAIIn:DELeTe</code>	474
<code>[SOURce<hw>]:PULM:TRAIIn:OFFTime</code>	474
<code>[SOURce<hw>]:PULM:TRAIIn:OFFTime:POINts</code>	475
<code>[SOURce<hw>]:PULM:TRAIIn:ONTime</code>	475
<code>[SOURce<hw>]:PULM:TRAIIn:ONTime:POINts</code>	476
<code>[SOURce<hw>]:PULM:TRAIIn:REPetition</code>	476
<code>[SOURce<hw>]:PULM:TRAIIn:REPetition:POINts</code>	477
<code>[SOURce<hw>]:PULM:TRAIIn:SElEct</code>	477
<code>[SOURce<hw>]:PULM:TRIGger:EXTernal:GATE:POLarity</code>	478
<code>[SOURce<hw>]:PULM:TRIGger:EXTernal:IMPedance</code>	478
<code>[SOURce<hw>]:PULM:TRIGger:EXTernal:LEVel</code>	478
<code>[SOURce<hw>]:PULM:TRIGger:EXTernal:SLOPe</code>	479

<code>[:SOURce<hw>]:PULM:TRIGger:MODE</code>	479
<code>[:SOURce<hw>]:PULM:TRAIin:DEXChange:AFILe:CATalog</code>	479
<code>[:SOURce<hw>]:PULM:TRAIin:DEXChange:AFILe:EXTension</code>	480
<code>[:SOURce<hw>]:PULM:TRAIin:DEXChange:AFILe:SELection</code>	480
<code>[:SOURce<hw>]:PULM:TRAIin:DEXChange:AFILe:SEParator:COLumn</code>	481
<code>[:SOURce<hw>]:PULM:TRAIin:DEXChange:AFILe:SEParator:DECimal</code>	481
<code>[:SOURce<hw>]:PULM:TRAIin:DEXChange:EXECute</code>	482
<code>[:SOURce<hw>]:PULM:TRAIin:DEXChange:MODE</code>	482
<code>[:SOURce<hw>]:PULM:TRAIin:DEXChange:SELection</code>	483
<code>[:SOURce<hw>]:PULM:WIDTh</code>	483

`[:SOURce<hw>]:PULM:DELay <Delay>`

The command sets the pulse delay. The pulse delay determines the time that elapses after a trigger event before pulse modulation starts. The pulse delay is not effective for double pulse generation.

Parameters:

`<Delay>` float
 Range: 10 ns to 100 s
 Increment: 20 ns
 *RST: 20 ns
 Default unit: ns

Example: `PULM:DEL 13 us`
 13 us elapse after a trigger before the first pulse is generated.

Options: Option R&S SMF-K23

`[:SOURce<hw>]:PULM:DOUBle:DELay <Delay>`

The command sets the delay from the start of the first pulse to the start of the second pulse.

Parameters:

`<Delay>` float
 Range: 10 ns to 100 s
 Increment: 20 ns
 *RST: 1 ms
 Default unit: ns

Example: `PULM:DOUB:DEL 22 us`
 22 us elapse between the beginning of the first pulse and the beginning of the second pulse in double-pulse mode.

Options: Option R&S SMF-K23

`[:SOURce<hw>]:PULM:DOUBle:STATe <State>`

The command enables/disables double pulse generation. The two pulses are generated in one pulse period.

Parameters:

<State> 0 | 1 | OFF | ON
 *RST: OFF

Example:

PULM:DOUB:STAT ON
 double-pulse mode is enabled.

Options:

Option R&S SMF-K23

[[:SOURce<hw>]:PULM:DOUBLE:WIDTH <Width>

The command sets the width of the second pulse in case of double pulse generation.

Parameters:

<Width> float
 Range: 5ns to 100s
 Increment: 20ns
 *RST: 1ms
 Default unit: ns

Example:

PULM:DOUB:WIDTh 33 us
 sets a width of 33 us for the second pulse.

Options:

Option R&S SMF-K23

[[:SOURce<hw>]:PULM:MODE <Mode>

Sets the mode of the pulse generator.

Parameters:

<Mode> SINGle | DOUBle | PTRain

SINGle

Enables single pulse generation.

DOUBle

Enables double pulse generation. The two pulses are generated in one pulse period.

PTRain

A user-defined pulse train is generated. The pulse train is defined by value pairs of on and off times that can be entered in a pulse train list.

*RST: SINGle

Example:

PULM:MODE DOUB
 enables double pulse generation.

Options:

R&S SMF-K23 and R&S SMF-K27

[[:SOURce<hw>]:PULM:OUTPut:VIDeo:POLarity <Polarity>

The command sets the polarity between modulating and modulated signal.

Parameters:

<Polarity> NORMal | INVerted

NORMal

The RF signal is suppressed during the pulse pause.

INVerted

The RF signal is suppressed during the pulse.

*RST: NORMal

Example:

PULM:SOUR EXT

selects the external modulation source.

PULM:OUTP:VID:POL INV

selects inverted polarity.

[[:SOURce<hw>]:PULM:PERiod <Period>

The command sets the period of the generated pulse. The period determines the repetition frequency of the internal signal.

Parameters:

<Period> float

Range: 5us | 20ns to 100 s

Increment: 1us | 20ns

*RST: 1ms

Example:

PULM:PER 220 us

the pulse period is 220 us.

Options:

The enhanced features require option R&S SMF-K23

[[:SOURce<hw>]:PULM:POLarity <Polarity>

The command sets the polarity between modulating and modulated signal. This command is only effective for an external modulation signal.

Parameters:

<Polarity> NORMal | INVerted

NORMal

The RF signal is suppressed during the pulse pause.

INVerted

The RF signal is suppressed during the pulse.

*RST: NORMal

Example:

PULM:SOUR EXT

selects the external modulation source.

Example:

PULM:POL INV

selects inverted polarity.

Options:

R&S SMF-K3

[:SOURce<hw>]:PULM:SOURce <Source>

The command selects the source for pulse modulation.

Parameters:

<Source> INTernal | EXTernal | RANDom

EXTernal

The signal applied externally via the PULSE IN connector is used for the pulse modulation.

INTernal

The internal pulse generator is used for the pulse modulation.

Note: This feature requires option R&S SMF-K23.

RANDom

Selects random pulses generated by the noise generator as the source for pulse modulation.

Example:

```
PULM:SOUR EXT
```

selects the external modulation source.

```
PULM:STAT ON
```

activates the pulse modulation.

Options:

R&S SMF-K23

[:SOURce<hw>]:PULM:STATe <State>

The command activates/deactivates the pulse modulation.

Parameters:

<State> 0 | 1 | OFF | ON

*RST: OFF

Example:

```
PULM:STAT ON
```

activates pulse modulation with the modulation source selected under `SOURce:PULM:SOURce`.

Usage:

SCPI confirmed

Options:

R&S SMF-K23

[:SOURce<hw>]:PULM:SYNC <Sync>

When enabled, the external modulation signal is synchronized to the internal 200MHz reference before it is passed to the pulse modulator. Since most instrument capabilities are timed by the same reference, the edges of the modulation signal can be synchronized e.g. to RF or to pulse modulator outputs if instrument is set up accordingly.

When disabled, the signal is passed asynchronously to the modulator.

Parameters:

<Sync> OFF | ON

Example:

```
PULM:SYNC OFF
```

the signal is passed asynchronously to the modulator.

[[:SOURce<hw>]:PULM:TRAI:n:CATalog?

The command requests a list of available pulse train files. The individual pulse train files are separated by commas.

The files are stored with the fixed file extensions `*.pulstrn` in a directory of the user's choice. The directory applicable to the commands is defined with the command `MMEMoRY:CDIR`.

Return values:

<Catalog> string

Example:

```
MMEM:CDIR 'var/lists/pulsetrain'
selects the directory for the pulse train files.
PULM:TRA:CAT?
queries the available files.
Response: 'P_CONS', 'P_INCR', 'P_DECR'
the lists P_CONS, P_INCR and P_DECR are available.
```

Usage: Query only

Options: R&S SMF-K27

[[:SOURce<hw>]:PULM:TRAI:n:DELeTe <Delete>

The command deletes the specified pulse train file.

The files are stored with the fixed file extensions `*.pulstrn` in a directory of the user's choice. The directory applicable to the command is defined with the command `MMEMoRY:CDIR`. To access the files in this directory, only the file name has to be given without the path and the file extension.

Setting parameters:

<Delete> <list file name>

Example:

```
MMEM:CDIR 'var/lists/pulsetrain'
selects the directory for the pulse train files.
PULM:TRA:DEL 'P_FIVE'
deletes the list P_FIVE
```

Usage: Setting only

Options: R&S SMF-K27

[[:SOURce<hw>]:PULM:TRAI:n:OFFTime <Offtime>

The command fills the Offtime part of the selected file with data.

*RST does not affect data lists.

Parameters:

<Offtime>

Offtime#1{, Offtime#2, ...} | binary block data

The data can be given either as a list of numbers (list can be of any length and list entries must be separated by commas) or as binary block data.

When block data is transferred, 8 (4) bytes are always interpreted as a floating-point number with double accuracy (see the command `FORMat:DATA`).

The maximum length is 1023 values.

Range: 5ns to 5ms

Example:

```
MMEM:CDIR 'var/lists/pulsetrain'
```

selects the directory for the pulse train files.

```
PULM:TRA:SEL 'P_INCR'
```

selects P_INCR for editing. P_INCR is created if it does not yet exist.

```
PULM:TRA:OFFT 10ns,15ns,40ns,...
```

specifies the offtime values in P_INCR. If the list already contains data, it is overwritten.

Options:

R&S SMF-K27

[:SOURce<hw>]:PULM:TRAI:OFFTime:POINts?

The command queries the length (in points) of the offtime component of the selected list.

Return values:

<Points>

float

Example:

```
MMEM:CDIR 'var/lists/pulsetrain'
```

selects the directory for the pulse train files.

```
PULM:TRA:SEL 'P_INCR'
```

selects P_INCR for editing. P_INCR is created if it does not yet exist.

```
PULM:TRA:OFFT:POIN?
```

queries the number of frequency values in P_INCR

```
Response: 7
```

P_INCR has 7 offtime entries.

Usage:

Query only

Options:

R&S SMF-K27

[:SOURce<hw>]:PULM:TRAI:ONTime <Overtime>

The command fills the Ontime part of the selected file with data.

Parameters:

<OnTime> Onime#1{, Onime#2, ...} | binary block data
 The data can be given either as a list of numbers (list can be of any length and list entries must be separated by commas) or as binary block data.
 When block data is transferred, 8 (4) bytes are always interpreted as a floating-point number with double accuracy (see the command `FORMat:DATA`).
 The maximum length is 1023 values.
 Range: 5ns to 5ms

Example:

```
MMEM:CDIR 'var/lists/pulsetrain'
selects the directory for the pulse train files.
PULM:TRA:SEL 'P_INCR'
selects P_INCR for editing. P_INCR is created if it does not yet exist.
PULM:TRA:ONT 10ns,15ns,40ns,...
specifies the ontime values in P_INCR. If the list already contains data, it is overwritten.
```

Options:

R&S SMF-K27

[:SOURce<hw>]:PULM:TRAI:n:ONTIME:POINts?

The command queries the length (in points) of the ontime component of the selected list.

Return values:

<Points> float

Example:

```
MMEM:CDIR 'var/lists/pulsetrain'
selects the directory for the pulse train files.
PULM:TRA:SEL 'P_INCR'
selects P_INCR for editing. P_INCR is created if it does not yet exist.
PULM:TRA:ONT:POIN?
queries the number of frequency values in P_INCR
Response: 7
P_INCR has 7 ontime entries.
```

Usage:

Query only

Options:

R&S SMF-K27

[:SOURce<hw>]:PULM:TRAI:n:REPetition <Repetition>

The command sets the number of repetitions for each ontime/offtime value pair. The maximum number of repetitions for all value pairs is 1023 values.

*RST does not affect data lists.

Parameters:

<Repetition> Repetition#1{, Repetition#2, ...}
 Range: 1 to max

Example:

```
MMEM:CDIR 'var/lists/pulsetrain'
selects the directory for the pulse train files.
PULM:TRA:SEL `P_INCR'
selects P_INCR for editing. P_INCR is created if it does not yet
exist.
PULM:TRA:ONT 10ns,15ns,40ns,...
specifies the ontime values in P_INCR. If the list already contains
data, it is overwritten.
PULM:TRA:OFFT 10ns,15ns,40ns,...
specifies the offtime values in P_INCR. If the list already contains
data, it is overwritten.
PULM:TRA:REP 10,15,40,...
specifies the number of repetitions for each value pair.
```

Options: R&S SMF-K27

[[:SOURce<hw>]:PULM:TRAI:REPitition:POINts?

The command queries the length (in points) of the repetition component of the selected list.

Return values:

<Points> float

Example:

```
MMEM:CDIR 'var/lists/pulsetrain'
selects the directory for the pulse train files.
PULM:TRA:SEL `P_INCR'
selects P_INCR for editing. P_INCR is created if it does not yet
exist.
PULM:TRA:REP:POIN?
queries the number of repetition values in P_INCR
Response: 7
P_INCR has 7 repetition entries.
```

Usage: Query only

Options: R&S SMF-K27

[[:SOURce<hw>]:PULM:TRAI:SElect <Select>

The command selects the specified pulse train file. If a new file is to be created, the name can be entered here. The file is created if it does not yet exist. The file selected here is available for the further processing steps (editing) and is used in the instrument when the pulse train mode is activated.

The files are stored with the fixed file extensions *.pulstrn in a directory of the user's choice. The directory applicable to the command is defined with the command
 MMEMory:CDIR.

*RST does not affect data lists.

Parameters:

<Select> string

Example:

```
MMEM:CDIR 'var/lists/pulsetrain'
selects the directory for the pulse train files.
PULM:TRA:SEL 'P_INCR'
selects P_INCR for editing. P_INCR is created if it does not yet
exist.
```

Options:

R&S SMF-K27

[:SOURce<hw>]:PULM:TRIGger:EXTernal:GATE:POLarity <Polarity>

Selects the polarity of the Gate signal.

The signal is supplied via the PULSE IN connector.

Parameters:

<Polarity> NORMal | INVerted
*RST: NORMal

Example:

```
PULM:TRIG:EXT:GAT:POL NORM
The pulse signal is generated while the gate signal is high.
```

[:SOURce<hw>]:PULM:TRIGger:EXTernal:IMPedance <Impedance>

The command selects the impedance for external pulse trigger.

Parameters:

<Impedance> G50 | G10K
*RST: G10K

Example:

```
SOUR:PULM:TRIG:EXT:IMP G50
selects 50 Ohm as the trigger impedance for the external pulse
trigger.
```

Usage:

SCPI confirmed

[:SOURce<hw>]:PULM:TRIGger:EXTernal:LEVel <Level>

The command selects the external trigger level (threshold TTL, 0.5 V or -2.5 V).

Parameters:

<Level> TTL | M2V5 | P0V5
*RST: POSitive

Example:

```
PULM:TRIG:EXT:LEV TTL
selects TTL as external trigger level.
```

[[:SOURce<hw>]:PULM:TRIGger:EXTernal:SLOPe <Slope>

The command sets the polarity of the active slope of an externally applied trigger signal at the TRIGGER input (BNC connector at the rear of the instrument).

Parameters:

<Slope> POS | NEG
*RST: POSitive

Example:

PULM:TRIG:EXT:SLOP NEG

The pulse generator is triggered on the negative slope of the external trigger signal.

[[:SOURce<hw>]:PULM:TRIGger:MODE <Mode>

The command selects the trigger mode for pulse modulation.

Parameters:

<Mode> AUTO | EXTernal | EGATe

AUTO

The pulse modulation is generated continuously.

EXTernal

The pulse modulation is triggered by an external trigger event. The trigger signal is supplied via the PULSE IN connector.

EGATe

The pulse modulation is triggered by an external trigger event. The trigger signal is supplied via the PULSE IN connector.

*RST: AUTO

Example:

PULM:TRIG:MODE EXT

selects triggering by an external trigger event.

Usage:

SCPI confirmed

[[:SOURce<hw>]:PULM:TRAIin:DEXChange:AFILe:CATalog?

The command requests a list of available ASCII files for export/import of pulse train data. The individual files are separated by commas.

The ASCII files are stored with the fixed file extensions *.txt or *.csv in a directory of the user's choice. The directory applicable to the commands is defined with the command MMEMory:CDIR.

Return values:

<Catalog> string

Example: MMEM:CDIR `var/lists/pulsetrain/import`
 selects the directory for the ASCII files with ontime/offtime/repetition values.
 PULM:TRA:DEXC:AFIL:EXT TXT
 selects that ASCII files with extension *.txt are listed.
 PULM:TRA:DEXC:AFIL:CAT?
 queries the available files with extension *.txt.
 Response: 'train1','train2'
 the ASCII files train1.txt and train2.txt are available.

Usage: Query only

[:SOURce<hw>]:PULM:TRAI:n:DEXChange:AFIL:EXTension <Extension>

The command selects the file extension of the ASCII file to be imported or exported. Selection TXT (text file) or CSV (Excel file) is available.

Parameters:

<Extension> TXT | CSV
 *RST: TXT

Example: MMEM:CDIR `var/lists/pulsetrain/import`
 selects the directory for the ASCII files with ontime/offtime/repetition values.
 PULM:TRA:DEXC:AFIL:EXT TXT
 selects that ASCII files with extension *.txt are listed.
 PULM:TRA:DEXC:AFIL:CAT?
 queries the available files with extension *.txt.
 Response: 'train1','train2'
 the ASCII files train1.txt and train2.txt are available.

[:SOURce<hw>]:PULM:TRAI:n:DEXChange:AFIL:SElect <Select>

The command selects the ASCII file to be imported or exported.

The ASCII files are stored with the fixed file extensions *.txt or *.csv in a directory of the user's choice. The directory applicable to the commands is defined with the command MMEMory:CDIR.

Parameters:

<Select> string

Example:

```
MMEM:CDIR 'var/lists/pulsetrain/import'
```

selects the directory for the ASCII files with ontime/offtime/repetition values.

```
PULM:TRA:DEXC:MODE IMP
```

selects that ASCII files with ontime/offtime/repetition values are imported and transferred into pulse train lists.

```
PULM:TRA:DEXC:AFIL:SEL 'train.csv'
```

selects that ASCII file `train.csv` is imported.

```
PULM:TRA:DEXC:SEL 'train_imp'
```

selects that the ASCII file `train.csv` is imported into pulse train list `train_imp`.

[:SOURce<hw>]:PULM:TRAI:n:DEXChange:AFILe:SEParator:COLumn <Column>

Parameters:

<Column> TABulator | SEMicolon | COMMa | SPACe
 *RST: SEMicolon

Example:

```
PULM:TRA:DEXC:MODE EXP
```

selects that the pulse train list is exported into an ASCII file.

```
MMEM:CDIR 'var/lists/pulsetrain/import'
```

selects the directory for the ASCII files with ontime/offtime/repetition values.

```
PULM:TRA:DEXC:AFIL:SEL 'train.csv'
```

selects ASCII file `train.csv` as destination for the pulse train list data.

```
PULM:TRA:DEXC:AFIL:SEP:COL TAB
```

the ontime/offtime/repetition values are separated by a tabulator.

```
PULM:TRA:DEXC:AFIL:SEP:DEC DOT
```

selects the decimal separator dot.

```
PULM:TRA:DEXC:SEL 'train_imp'
```

selects that the pulse train list `train_imp` is imported into ASCII file `train.csv`.

[:SOURce<hw>]:PULM:TRAI:n:DEXChange:AFILe:SEParator:DECimal <Decimal>

The command selects the decimal separator used in the ASCII data between '.' (decimal point) and ',' (comma) with floating-point numerals.

Parameters:

<Decimal> DOT | COMMa
 *RST: DOT

Example:

```
PULM:TRA:DEXC:MODE EXP
selects that the pulse train list is exported into an ASCII file.
MME:CDIR 'var/lists/pulsetrain/import'
selects the directory for the ASCII files with fontime/offtime/repetition values.
PULM:TRA:DEXC:AFIL:SEL 'train.csv'
selects ASCII file train.csv as destination for the pulse train list data.
PULM:TRA:DEXC:AFIL:SEP:COL TAB
the ontime/offtime/repetition values are separated by a tabulator.
PULM:TRA:DEXC:AFIL:SEP:DEC DOT
selects the decimal separator dot.
PULM:TRA:DEXC:SEL 'train_imp'
selects that the pulse train list train_imp is imported into ASCII file train.csv.
```

[:SOURce<hw>]:PULM:TRAI:n:DEXChange:EXECute

The command starts the export or import of the selected file. When import is selected, the ASCII file is imported as pulse train list. When export is selected, the pulse train list is exported into the selected ASCII file.

Example:

```
PULM:TRA:DEXC:MODE IMP
selects that ASCII files with ontime/offtime/repetition values are imported and transferred into pulse train lists.
MME:CDIR 'var/lists/pulsetrain/import'
selects the directory for the ASCII files with ontime/offtime/repetition values.
PULM:TRA:DEXC:AFIL:SEL 'train.csv'
selects that ASCII file train.csv is imported.
PULM:TRA:DEXC:SEL 'train_imp'
selects that the ASCII file train.csv is imported into pulse train list train_imp.
PULM:TRA:DEXC:EXEC
starts the import of the ASCII file data into the pulse train file.
```

Usage: Event

[:SOURce<hw>]:PULM:TRAI:n:DEXChange:MODE <Mode>

The command selects if pulse train lists should be imported or exported. Depending on the selection, the file select command define either the source or the destination for pulse train lists and ASCII files.

Parameters:

```
<Mode>          IMPort | EXPort
*RST:           IMPort
```

Example:

```
PULM:TRA:DEXC:MODE IMP
selects that ASCII files with ontime/offtime/repetition values are
imported and transferred into pulse train lists.
MME:CDIR 'var/lists/pulsetrain/import'
selects the directory for the ASCII files with ontime/offtime/repeti-
tion values.
PULM:TRA:DEXC:AFIL:SEL 'train.csv'
selects that ASCII file train.csv is imported.
PULM:TRA:DEXC:SEL 'train_imp'
selects that the ASCII file train.csv is imported into pulse train
list train_imp.
```

[:SOURce<hw>]:PULM:TRAI:DEXChange:SElect <Select>

The command selects the pulse train list to be imported or exported.

The pulse train files are stored with the fixed file extensions `*.pulstrn` in a directory of the user's choice. The directory applicable to the commands is defined with the command `MME:CDIR`.

Parameters:

<Select> string

Example:

```
PULM:TRA:DEXC:MODE IMP
selects that ASCII files with ontime/offtime/repetition values are
imported and transferred into pulse train lists.
MME:CDIR 'var/lists/pulsetrain/import'
selects the directory for the ASCII files with ontime/offtime/repeti-
tion values.
PULM:TRA:DEXC:AFIL:SEL 'train.csv'
selects that ASCII file train.csv is imported.
PULM:TRA:DEXC:SEL 'train_imp'
selects that the ASCII file train.csv is imported into pulse train
list train_imp.
```

[:SOURce<hw>]:PULM:WIDTh <Width>

The command sets the width of the generated pulse. The width determines the pulse length. The pulse width must be at least 20ns less than the set pulse period.

Parameters:

<Width> float

Range: 20ns | 5ns to 100s

Increment: 20ns

*RST: 1ms

Example:

```
PULM:WIDT 33 us
sets a width of 33 us for the pulse.
```

Options:

The enhanced features require option R&S SMF-K23

7.12.17 SOURce:ROSCillator Subsystem

This subsystem contains the commands for setting the external and internal reference frequency.



The commands of this subsystem are not affected by an instrument reset (***RST** on page 308).

<code>[:SOURce]:ROSCillator:EFC:STATe</code>	484
<code>[:SOURce]:ROSCillator:EXTernal:FREQUency</code>	484
<code>[:SOURce]:ROSCillator:EXTernal:RFOff:STATe</code>	484
<code>[:SOURce]:ROSCillator:EXTernal:SBANdwidth</code>	485
<code>[:SOURce]:ROSCillator[:INTernal]:ADJust:VALue</code>	485
<code>[:SOURce]:ROSCillator[:INTernal]:ADJust[:STATe]</code>	486
<code>[:SOURce]:ROSCillator:SOURce</code>	486
<code>[:SOURce]:ROSCillator:OUTPut:SOURce</code>	486

[:SOURce]:ROSCillator:EFC:STATe <State>

The command activates/deactivates the electronic frequency control.

Parameters:

<State> 0 | 1 | OFF | ON

Example:

`ROSC:EFC:STAT ON`
activates the electronic frequency control.

Usage:

SCPI confirmed

[:SOURce]:ROSCillator:EXTernal:FREQUency <Frequency>

The command informs the instrument of the frequency of the external reference. Entries are possible in 1 MHz steps.

Parameters:

<Frequency> float
Range: 1 to 20

Example:

`ROSC:SOUR EXT`
selects the external source. The reference must be input at the REF IN input connector.
`ROSC:EXT:FREQ 5 MHz`
informs the instrument that the external reference frequency is 5 MHz.

[:SOURce]:ROSCillator:EXTernal:RFOff:STATe <State>

The command determines if the RF output is switched off in case of a missing external reference signal for selection external source.

If enabled, this setting ensures that no improper RF signal due to the missing external reference signal is output and used for measurements.

In addition to the error message "Ext Ref missing", message "RF output deactivated" is generated.

Parameters:

<State> 0 | 1 | OFF | ON

Example:

ROSC:SOUR EXT

selects the external source. The reference must be input at the REF IN input.

Example:

ROSC:EXT:RFOF:STAT ON

In case of a missing external signal, no RF signal is output.

[:SOURce]:ROSCillator:EXTernal:SBANdwidth <Sbandwidth>

The command selects the synchronization bandwidth for an external reference signal.

Parameters:

<Sbandwidth> WIDE | NARRow

NARRow

Synchronization bandwidth is approx. 1 Hz.

WIDE

Synchronization bandwidth is approx. 750 Hz.

This mode is the standard mode, it is provided for using good reference sources of high spectral purity.

Example:

ROSC:SOUR EXT

selects the external source.

ROSC:EXT:FREQ 5 MHz

informs the instrument that the external reference has a frequency of 5 MHz.

ROSC:EXT:SBAN WID

selects wideband setting for synchronization bandwidth.

[:SOURce]:ROSCillator[:INTernal]:ADJust:VALue <Value>

The command specifies the frequency correction value (adjustment value).

Parameters:

<Value> float

Range: 0 to 4095

Increment: 1

Example:

ROSC:ADJ:VAL 1400

sets the adjustment value to 1400.

[[:SOURce]:ROSCillator[:INTernal]:ADJust[:STATe]] <State>

The command determines whether the calibrated (OFF) or a user-defined (ON) adjustment value is used for fine adjustment of the frequency. With STATe ON, the instrument is no longer in the calibrated state. However, the calibration value is not changed and the instrument resumes the calibrated state after switching the Adjustment State to Off.

Parameters:

<State> 0 | 1 | OFF | ON
 *RST: 0

Example:

```
ROSC:SOUR INT
selects the internal source.
ROSC:ADJ ON
activates use of a user-defined adjustment value.
ROSC:ADJ:VAL 1400
sets the adjustment value to 1400.
```

[[:SOURce]:ROSCillator:SOURce <Source>

The command selects between internal and external reference frequency.

Parameters:

<Source> INTernal | EXTernal

INTernal

The internal reference oscillator is used.

The reference signal is provided at the REF OUT connector

EXTernal

An external reference signal is used. It must be input at the REF IN connector at the rear of the instrument.

The instrument is informed of the frequency of the external reference signal by means of the command `[[:SOURce]:`

`ROSCillator:EXTernal:FREQuency.`

Example:

```
ROSC:SOUR EXT
selects the external source.
ROSC:EXT:FREQ 5 MHz
informs the instrument that the external reference has a frequency
of 5 MHz.
```

[[:SOURce]:ROSCillator:OUTPut:SOURce <Source>

The command selects the source for the reference oscillator signal output. The external output is only available if the external reference frequency is 10 MHz.

Parameters:`<Source>` INTERNAL | EXTERNAL**INTERNAL**

The internal reference oscillator signal is output at the REF OUT connector.

EXTERNAL

The external reference oscillator signal is output at the REF OUT connector

Example:

```
ROSC:OUTP:SOUR EXT
```

the reference oscillator signal is output at the REF OUT connector.

7.12.18 SOURce:SWEep Subsystem

This subsystem contains the commands for checking the RF sweeps, i.e. the sweeps of the RF generators. Sweeps are always triggered, except for the MANUAL sweep mode. The frequency sweep is activated by the command `SOURce:FREQuency:MODE SWEep`, and the level sweep by the command `SOURce:POWEr:MODE SWEep`. All sweeps, including the LF sweep, can be set independently of each other.

This example shows how to set up a frequency sweep.

1. Set the sweep range.

```
[SOURce:]FREQuency:CENTer 200 MHz  
[SOURce:]FREQuency:SPAN 300 MHz
```
2. Select linear or logarithmic spacing.

```
[SOURce:]SWEep[:FREQuency]:SPACing LIN
```
3. Set the step width and dwell time.

```
[SOURce:]SWEep[:FREQuency]:STEP:LINear 20 MHz  
[SOURce:]SWEep[:FREQuency]:DWELl 12 ms
```
4. Select the trigger mode.

```
TRIGger:]FSweep:SOURce SINGLE
```
5. Select the sweep mode and activate the sweep.

```
[SOURce:]SWEep[:FREQuency]:MODE AUTO  
[SOURce:]FREQuency:MODE SWEep
```
6. Trigger the sweep.

```
[SOURce:]SWEep[:FREQuency]:EXECute
```



It is recommended to switch off the "GUI Update" for optimum sweep performance especially with short dwell times (`SYSTEM:DISPlay:UPDate OFF`).

<code>[SOURce<hw>]:SWEep[:FREQuency]:DWELl</code>	488
<code>[SOURce<hw>]:SWEep[:FREQuency]:EXECute</code>	488
<code>[SOURce<hw>]:SWEep[:FREQuency]:MARKer:ACTIve</code>	489

[:SOURce<hw>]:SWEep[:FREQUENCY]:MARKer:AMPLitude.....	489
[:SOURce<hw>]:SWEep[:FREQUENCY]:MARKer:AOff.....	489
[:SOURce<hw>]:SWEep[:FREQUENCY]:MARKer<ch>:FREQUENCY.....	490
[:SOURce<hw>]:SWEep[:FREQUENCY]:MARKer<ch>:FState.....	490
[:SOURce<hw>]:SWEep[:FREQUENCY]:MARKer<ch>:PState.....	490
[:SOURce<hw>]:SWEep[:FREQUENCY]:MARKer:XFer.....	490
[:SOURce<hw>]:SWEep[:FREQUENCY]:MODE.....	491
[:SOURce<hw>]:SWEep[:FREQUENCY]:POINts.....	491
[:SOURce<hw>]:SWEep[:FREQUENCY]:SHAPE.....	492
[:SOURce<hw>]:SWEep[:FREQUENCY]:SPACing.....	492
[:SOURce<hw>]:SWEep[:FREQUENCY]:STEP[:LInear].....	493
[:SOURce<hw>]:SWEep[:FREQUENCY]:STEP:LOGarithmic.....	494
[:SOURce<hw>]:SWEep[:FREQUENCY]:TIME.....	494
[:SOURce<hw>]:SWEep:MARKer:OUTPut:POLarity.....	495
[:SOURce<hw>]:SWEep:POWer:AMode.....	495
[:SOURce<hw>]:SWEep:POWer:DWELl.....	495
[:SOURce<hw>]:SWEep:POWer:EXECute.....	496
[:SOURce<hw>]:SWEep:POWer:MARKer:ACTive.....	496
[:SOURce<hw>]:SWEep:POWer:MARKer:AOff.....	496
[:SOURce<hw>]:SWEep:POWer:MARKer<ch>:POWer.....	497
[:SOURce<hw>]:SWEep:POWer:MARKer<ch>:STATE.....	497
[:SOURce<hw>]:SWEep:POWer:MODE.....	497
[:SOURce<hw>]:SWEep:POWer:POINts.....	498
[:SOURce<hw>]:SWEep:POWer:SHAPE.....	498
[:SOURce<hw>]:SWEep:POWer:SPACing:MODE.....	498
[:SOURce<hw>]:SWEep:POWer:STEP[:LOGarithmic].....	499
[:SOURce<hw>]:SWEep:RESet[:ALL].....	499

[:SOURce<hw>]:SWEep[:FREQUENCY]:DWELl <Dwell>

The command sets the time taken for each frequency step of the sweep.

The keyword [:FREQUENCY] can be omitted (see example). The command is then SCPI-compliant.

Tip: It is recommended to switch off the "GUI Update" for optimum sweep performance especially with short dwell times (**SYSTem:DISPlay:UPDate OFF**).

Parameters:

<Dwell>	float
	Range: 10.0E-3 to 100
	Increment: 100.0E-6
	*RST: 10.0E-3
	Default unit: s

Example:

```
SWE:DWEL 12 ms
sets a dwell time of 12 ms for a frequency sweep at the RF output.
```

[:SOURce<hw>]:SWEep[:FREQUENCY]:EXECute

The command triggers a sweep.

The command is only valid for sweep mode Single (SOURce:SWEep:FREQuency:MODE SINGle). The command corresponds to the manual-control command "Execute Single Sweep".

Example: SWE:FREQ:EXEC
triggers a frequency sweep at the RF output.

Usage: Event

[:SOURce<hw>]:SWEep[:FREQuency]:MARKer:ACTive <Active>

The command activates the selected marker. The active marker is output with a higher voltage than all other markers.

Parameters:

<Active> NONE | M01 | M02 | M03 | M04 | M05 | M06 | M07 | M08 | M09 | M10
*RST: NONE

Example: SOUR:SWE:FREQ:MARK:ACT M05
sets marker 5 to be the active marker.

[:SOURce<hw>]:SWEep[:FREQuency]:MARKer:AMPLitude <Amplitude>

The command sets the amplitude marker attenuation. This value is valid for all markers.

Correlation: The output level reduction is applied to a marker with command SOUR:SWE:MARK<[1]...10>:PST ON.

Parameters:

<Amplitude> float
Range: 0 to 3
Increment: 0.1
*RST: 1
Default unit: dB

Example: SOUR:SWE:FREQ:MARK:AMPL 1
the output level is reduced by 1 dB on reaching the mark.

[:SOURce<hw>]:SWEep[:FREQuency]:MARKer:AOFF

The command switches off all frequency markers. The command triggers an event and therefore has no query form and no *RST value.

Example: SOUR:SWE:FREQ:MARK:AOFF
switches off all frequency markers.

Usage: Event

[:SOURce<hw>]:SWEep[:FREQUENCY]:MARKer<ch>:FREQuency <Frequency>

The command sets the frequency of the selected marker. If the marker is switched on, the signal level at the MARKER output changes on reaching the frequency mark.

Parameters:

<Frequency> float
 Range: 0.1 MHz to 22.0 GHz
 *RST: 1.0 GHz

Example:

SWE:FREQ:MARK1:FREQ 1.5GHz
 sets the frequency mark for marker 1 to 1.5 GHz.

[:SOURce<hw>]:SWEep[:FREQUENCY]:MARKer<ch>:FSTate <Fstate>

The command switches on or off the selected marker. If the marker is switched on, the signal level at the MARKER output changes on reaching the frequency mark.

Parameters:

<Fstate> 0 | 1 | OFF | ON
 *RST: OFF

Example:

SWE:MARK1:FST ON
 switches on marker 1.

[:SOURce<hw>]:SWEep[:FREQUENCY]:MARKer<ch>:PSTate <Pstate>

Activates or deactivates the selected amplitude marker. If activated, the level is reduced by the amplitude entered with command

[:SOURce:]SWEep[:FREQUENCY]:MARKer:AMPLitude on reaching the mark.

Parameters:

<Pstate> 0 | 1 | OFF | ON
 *RST: OFF

Example:

SWE:MARK1:PST ON
 the output level is reduced by a constant value if frequency marker 1 is active.

[:SOURce<hw>]:SWEep[:FREQUENCY]:MARKer:XFER

Copies the frequency value of marker 1 to the start frequency of the sweep and the frequency value of marker 2 to the stop frequency of the sweep.

The command is an event and thus has no *RST-value and no query form.

Dependencies: Sets the start and stop frequency of the sweep.

Example:

SWE:MARK:XFER
 used the frequency values of marker 1 and 2 to set the start and stop frequency, respectively.

Usage:

Event

[:SOURce<hw>]:SWEep[:FREQuency]:MODE <Mode>

The command sets the sweep mode.

The keyword [:FREQuency] can be omitted (see example). The command is then SCPI-compliant.

Parameters:

<Mode>

AUTO | MANual | STEP

AUTO

Each trigger triggers exactly one complete sweep.

MANual

The trigger system is not active. Each frequency step of the sweep is triggered individually, either by varying the "Current Frequency" value using the rotary knob under manual control or by means of a `FREQ:MAN` command under remote control. With manual control, the frequency increases or decreases (depending on the direction of the rotary encoder) by the value specified under `FREQ:STEP:INCRement`. With remote control, the frequency is set directly with the command `:FREQ:MAN`.

STEP

Each trigger triggers one sweep step only (Mode Single Step).

The frequency increases by the value entered under

`SOUR:SWE:FREQ:STEP:LIN` (linear spacing)

or `...:STEP:LOG` (logarithmic spacing).

*RST: AUTO

Example:

`SWE:MODE AUTO`

selects **Mode Auto** for a frequency sweep at the RF output.

[:SOURce<hw>]:SWEep[:FREQuency]:POINTs <Points>

The command sets the number of steps in an RF sweep.

The command is linked to the command `:SWEep[:FREQuency]:STEP` as follows:

- for linear sweeps
 $POINTs = (SPAN / STEP:LIN) + 1$
- logarithmic sweeps and `START < STOP`:
 $POINTs = ((\log STOP - \log START) / \log STEP:LOG) + 1$

If `POINTs` changes, the value of `STEP` is adjusted. The `START` and `STOP` value is retained.

Two separate `POINTs` values are used for linear or logarithmic sweep spacing (`:SWEep[:FREQuency]:SPACing LIN | LOG`). The command is always effective for the currently set sweep spacing.

Note: The value indicated in the menu and the value set/retrieved by this command differ by 1 as a rule. This is caused by a different calculation of the value indicated in the menu (e.g. linear spacing): $Count = (Stop - Start) / Step:Log$. (i.e, the transitions are counted not the steps as in remote control) Also, the value is in any case an integer, thus may be rounded.

Parameters:

<Points> float

Example:

```
FREQ:STAR
```

sets the start frequency to 100 MHz.

```
FREQ:STOP
```

sets the stop frequency to 500 MHz.

```
SWE:SPAC LIN
```

sets linear sweep spacing.

```
SWE:POIN 401
```

sets 401 sweep steps for linear sweep spacing. The sweep step width (`STEP`) is automatically set to 1 MHz.

[:SOURce<hw>]:SWEep[:FREQUENCY]:SHAPE <Shape>

The command sets the cycle mode for a sweep sequence (shape).

Parameters:

<Shape> SAWTooth | TRIangle

SAWTooth

One sweep runs from start to stop frequency. Each subsequent sweep starts at the start frequency, i.e. the shape of the sweep sequence resembles a sawtooth.

TRIangle

One sweep runs from start to stop frequency and back, i.e. the shape of the sweep resembles a triangle. Each subsequent sweep starts at the start frequency.

```
*RST: SAWTooth
```

Example:

```
SOUR:SWE:SHAP TRI
```

selects the sweep cycle with alternating ascending and descending sweep directions.

[:SOURce<hw>]:SWEep[:FREQUENCY]:SPACING <Spacing>

The command selects the sweep spacing.

The keyword `[:FREQUENCY]` can be omitted (see example). The command is then SCPI-compliant.

Parameters:

<Spacing>

LINear | LOGarithmic | RAMP

LINear

With the linear sweep, the step width is a fixed frequency value which is added to the current frequency. The step width for linear sweep is entered in Hz (see [:SOURce<hw>]:SWEep[:FREQuency]:STEP[:LINear] on page 493).

LOGarithmic

With the logarithmic sweep, the step width is a constant fraction of the current frequency. This fraction is added to the current frequency. The logarithmic step width is entered in % (see [:SOURce<hw>]:SWEep[:FREQuency]:STEP:LOGarithmic on page 494).

RAMP

With the ramp sweep, a synthesized continuous analog frequency sweep is provided for a set sweep time. The sweep time is entered under [:SOURce<hw>]:SWEep[:FREQuency]:TIME on page 494.

*RST: LIN

Example:

SWE:SPAC LIN

selects linear sweep spacing for a frequency sweep at the RF output.

[[:SOURce<hw>]:SWEep[:FREQuency]:STEP[:LINear] <Linear>

The command sets the step width for linear sweeps.

This command is linked to the command :SWEep[:FREQuency]:POINTs as follows:

$$\text{POINTs} = (\text{SPAN} / \text{STEP:LIN}) + 1$$

If STEP:LIN changes, the value of POINTs is adjusted. The START and STOP value is retained.

The keywords [:FREQuency] and [:LINear] can be omitted (see example). The command is then SCPI-compliant.

Parameters:

<Linear>

float

Range: 0.001 Hz to (STOP - START)

Increment: 0.001 Hz

*RST: 1 MHz

Default unit: MHz

Example:

```
FREQ:STAR 1GHz
sets the start frequency to 1 GHz.
FREQ:STOP 5GHz
sets the stop frequency to 5 GHz.
SWE:SPAC LIN
sets linear sweep spacing.
SWE:STEP 2 MHz
sets the step width for linear sweep spacing to 2 MHz (RF sweep)
at the RF output. The number of sweep steps for linear sweep
spacing (POINTs) is automatically set to 2001.
```

[:SOURce<hw>]:SWEep[:FREQUENCY]:STEP:LOGarithmic <Logarithmic>

The command specifies the step width factor for logarithmic sweeps. The next frequency value of a sweep is calculated (for `START < STOP`) using the following formula:

New frequency = Old frequency + `STEP:LOG` x Old frequency

`STEP:LOG` therefore gives the fraction of the old frequency. The frequency is increased by this fraction for the next sweep step. Usually `STEP:LOG` is given in percent, whereby the suffix `PCT` must always be used.

The command is linked to the command `:SWEep[:FREQUENCY]:POINTs` for `START < STOP` as follows:

$$\text{POINTs} = ((\log \text{STOP} - \log \text{START}) / \log \text{STEP:LOG}) + 1$$

If `STEP:LOG` changes, the value of `POINTs` is adjusted. The `START` and `STOP` value is retained.

Parameters:

<Logarithmic>	float
	Range: 0.01 to 9999
	Increment: 0.01 PCT
	*RST: 1 PCT

Example:

```
FREQ:STAR 1GHz
sets the start frequency to 1 GHz.
FREQ:STOP 5GHz
sets the stop frequency to 5 GHz.
SWE:SPAC LOG
sets logarithmic sweep spacing.
SWE:STEP:LOG 10PCT
sets the step width for logarithmic sweep spacing to 10% of the
previous frequency in each instance (for a frequency sweep).
```

[:SOURce<hw>]:SWEep[:FREQUENCY]:TIME <Time>

The command sets the sweep time for ramp sweep.

Parameters:

<Time> float
 Range: 10.0 ms to 100 s
 *RST: 15E-3

Example:

SOUR:FREQ:TIME 10ms
 sets a sweep time of 10 ms for a ramp sweep.

Options:

R&S SMF-K4

[[:SOURce<hw>]:SWEep:MARKer:OUTPut:POLarity <Polarity>

The command selects the polarity of the marker signal.

Parameters:

<Polarity> NORMal | INVerted
NORMal
 The marker level switches to HIGH after reaching the mark.
INVerted
 The marker level switches to LOW after reaching the mark.
 *RST: NORMal

Example:

SWE:FREQ:MARK:OUTP:POL NORM
 sets the marker output polarity to normal.

Options:

R&S SMF-B20

[[:SOURce<hw>]:SWEep:POWer:AMODe <Amode>

The command selects the ranges of level settings for the level sweep. The sweep is either performed in the low level or in the high level ranges.

Parameters:

<Amode> NORMal | HPOWer
NORMal
 The level settings are made in the range of the electronically switching attenuator. The high level ranges are not available.
HPOWer
 The level settings are made in the high level range.
 *RST: NORMal

Example:

SWE:POW:AMOD HPOW
 selects the high level ranges for level sweep.

[[:SOURce<hw>]:SWEep:POWer:DWELI <Dwell>

The command sets the time taken for each level step of the sweep.

Tip: It is recommended to switch off the "GUI Update" for optimum sweep performance especially with short dwell times ([SYSTem:DISPlay:UPDate OFF](#)).

Parameters:

<Dwell> float
 Range: 1.0E-3 to 100
 Increment: 100.0E-6
 *RST: 15.0E-3
 Default unit: s

Example:

SWE:POW:DWEL 12 ms
 sets a dwell time of 12 ms for a level sweep at the RF output.

[SOURce<hw>]:SWEep:POWer:EXECute

The command triggers a sweep.

The sweep to be executed depends on the set sweep mode (SOURce:SWEep:POWer:MODE). The command corresponds to the manual-control command "Execute Trigger".

Example:

SWE:POW:MODE STEP
 sets the STEP trigger mode, i.e. a trigger starts the sweep initially, and then the sweep is generated continuously.
 SWE:POW:EXEC
 triggers a level sweep at the RF output.

Usage:

Event

[SOURce<hw>]:SWEep:POWer:MARKer:ACTive <Active>

The command activates the selected marker. The active marker is output with an higher voltage than all other markers.

Parameters:

<Active> NONE | M01 | M02 | M03 | M04 | M05 | M06 | M07 | M08 | M09 | M10
 *RST: NONE

Example:

SWE:POW:MARK:ACT M05
 sets marker 5 to be the active marker.

[SOURce<hw>]:SWEep:POWer:MARKer:AOff

The command switches off all level markers. The command triggers an event and therefore has no query form and no *RST value.

Example:

SOUR:SWE:POW:MARK:AOff
 switches off all level markers.

Usage:

Event

[[:SOURce<hw>]:SWEep:POWer:MARKer<ch>:POWer <Power>

The command sets the level of the selected marker. If the marker is switched on, the signal level at the MARKER output changes on reaching the level mark.

Parameters:

<Power> float
 *RST: 0
 Default unit: dBm

Example:

SOUR:SWE:POW:MARK1:POW -50
 sets the power mark for marker 1 to -50 dBm.

[[:SOURce<hw>]:SWEep:POWer:MARKer<ch>:STATe <State>

The command switches on or off the selected marker. If the marker is switched on, the signal level at the MARKER output changes on reaching the level mark.

Parameters:

<State> 0 | 1 | OFF | ON
 *RST: OFF

Example:

SWE:POW:MARK1:STAT ON
 switches on marker 1.

[[:SOURce<hw>]:SWEep:POWer:MODE <Mode>

The command sets the cycle mode of the level sweep.

Parameters:

<Mode> AUTO | MANual | STEP

AUTO

Each trigger triggers exactly one complete sweep.

MANual

The trigger system is not active. Each level step of the sweep is triggered individually, either by varying the "Current Level" value using the rotary knob under manual control or by means of a POW:MAN command under remote control.

With manual control, the level increases or decreases (depending on the direction of the rotary encoder) by the value specified under SOUR:SWE:POW:STEP. With remote control, the level increases by the value specified under SWEep:POW:STEP which each sent :POW:MAN command, irrespective the value entered there.

STEP

Each trigger triggers one sweep step only. The level increases by the value entered under :SWEep:POWer:STEP.

*RST: AUTO

Example:

SWE:POW:MODE AUTO
 selects Mode Auto for a level sweep at RF output.

[[:SOURce<hw>]:SWEep:POWer:POINts <Points>

The command sets the number of steps in a level sweep. The command is linked to the command `:SWEep:POWer:STEP` as follows:

$$\text{POINTs} = ((\text{STOP} - \text{START}) / \text{STEP:LOG}) + 1$$

If `POINTs` changes, the value of `STEP` is adjusted. The `START` and `STOP` value is retained.

Note: The value indicated in the menu and the value set/retrieved by this command differ by 1 as a rule. This is caused by a different calculation of the value indicated in the menu: $\text{Count} = (\text{Stop} - \text{Start}) / \text{Step:Log}$ (i.e., the transitions are counted not the steps as in remote control). Also, the value is in any case an integer, thus may be rounded.

Parameters:

<Points> float
*RST: 20dB

Example:

```
POW:STAR - 30 dBm
sets the start frequency to -30 dBm.
POW:STOP - 10 dBm
sets the stop frequency to -10 dBm.
SWE:POW:POIN 20
sets 20 sweep steps. The sweep step width (STEP) is automatically set to 1 dB.
```

[[:SOURce<hw>]:SWEep:POWer:SHAPE <Shape>

The command sets the cycle mode for a sweep sequence (shape).

Parameters:

<Shape> SAWTooth | TRIangle

SAWTooth

One sweep runs from the start level to the stop level. The subsequent sweep starts at the start level again, i.e. the shape of sweep sequence resembles a sawtooth.

TRIangle

One sweep runs from start to stop level and back, i.e. the shape of the sweep resembles a triangle. Each subsequent sweep starts at the start level again.

*RST: SAWTooth

Example:

```
SOUR:SWE:POW:SHAP TRI
selects the sweep cycle with alternating ascending and descending sweep directions.
```

[[:SOURce<hw>]:SWEep:POWer:SPACing:MODE?

The command queries the sweep spacing. The sweep spacing for level sweeps is always linear.

Example: `SWE:POW:SPAC:MODE?`
 queries the sweep spacing for a level sweep at RF output.
 Result: LIN
 linear spacing

Usage: Query only

[:SOURce<hw>]:SWEep:POWer:STEP[:LOGarithmic] <Logarithmic>

The command sets the step width factor for logarithmic sweeps. The next level value of a sweep is calculated (for `START < STOP`) using the following formula:

$$\text{New level} = \text{Old level} + \text{STEP:LOG} \times \text{Old level}$$

`STEP:LOG` therefore gives the fraction of the old level. The level is increased by this fraction for the next sweep step. Usually `STEP:LOG` is given in decibels, whereby the suffix dB must always be used.

The command is linked to the command `:SWEep:POWer:POINTs` for `START < STOP` as follows:

$$\text{POINTs} = ((\text{STOP} - \text{START}) / \text{STEP:LOG}) + 1$$

If `STEP:LOG` changes, the value of `POINTs` is adjusted. The `START` and `STOP` value is retained.

Parameters:

<Logarithmic> float
 Range: 0.01 to 139 dB
 Increment: 0.01 dB
 *RST: 1

Example: `SWE:POW:STEP 10dB`
 sets the step width for logarithmic sweep spacing to 10 dB of the previous level in each instance (for a level sweep).

[:SOURce<hw>]:SWEep:RESet[:ALL]

The command resets all active sweeps to the starting point.

Example: `SWE:RES`
 resets all active sweeps to the starting point.

7.13 STATus Subsystem

This system contains the commands for the status reporting system. *RST on page 308 has no effect on the status registers.

Queries return the current value of the respective register, which permits a check of the device status. A decimal value between 0 and 32767 ($=2^{15}-1$) is returned.

The configuration commands set the respective register thus determining which status changes of the R&S SMF causes the status registers to be changed. A decimal value between 0 and 32767 ($= 2^{15}-1$) is set.

STATus:OPERation:CONDition.....	500
STATus:OPERation:ENABle.....	500
STATus:OPERation[:EVENT].....	500
STATus:OPERation:NTRansition.....	501
STATus:OPERation:PTRansition.....	501
STATus:PRESet.....	501
STATus:QUESTionable:CONDition.....	502
STATus:QUESTionable:ENABle.....	502
STATus:QUESTionable[:EVENT].....	502
STATus:QUESTionable:NTRansition.....	503
STATus:QUESTionable:PTRansition.....	503
STATus:QUEue[:NEXT].....	503

STATus:OPERation:CONDition? <Condition >

The command queries the content of the CONDition part of the STATus:OPERation register. This part contains information on the action currently being performed in the instrument. The content is not deleted after being read out since it indicates the current hardware status.

Parameters:

<Condition > string

Example:

STAT:OPER:COND
queries the Status:Operation:Condition register.

Usage:

Query only
SCPI confirmed

STATus:OPERation:ENABle <Enable>

The command sets the bits of the ENABle part of the STATus:OPERation register. This setting determines which events of the Status-Event part are forwarded to the sum bit in the status byte. These events can be used for a service request.

Parameters:

<Enable> string

Example:

STAT:OPER:ENAB 32767
all events are forwarded to the sum bit of the status byte.

Usage:

SCPI confirmed

STATus:OPERation[:EVENT]? <EVENT>

The command queries the content of the EVENT part of the STATus:OPERation register. This part contains information on the actions performed in the instrument since the last readout. The content of the EVENT part is deleted after being read out.

Parameters:**<EVENT>** string**Example:**

STAT:OPER:EVEN

queries the STATus:OPERation:EVENT register.

Usage:Query only
SCPI confirmed**STATus:OPERation:NTRansition <Ntransition>**

The command sets the bits of the NTRansition part of the STATus:OPERation register. If a bit is set, a transition from 1 to 0 in the condition part causes an entry to be made in the EVENT part of the register. The disappearance of an event in the hardware is thus registered, e.g. the end of an adjustment.

Parameters:**<Ntransition>** string**Example:**

STAT:OPER:NTR 0

a transition from 1 to 0 in the condition part of the Status:Operation register does not cause an entry to be made in the EVENT part.

Usage:

SCPI confirmed

STATus:OPERation:PTRansition <Ptransition>

The command sets the bits of the PTRansition part of the STATus:OPERation register. If a bit is set, a transition from 0 to 1 in the condition part causes an entry to be made in the EVENT part of the register. A new event in the hardware is thus registered, e.g. the start of an adjustment.

Parameters:**<Ptransition>** string**Example:**

STAT:OPER:PTR 32767

all transitions from 0 to 1 in the condition part of the Status:Operation register cause an entry to be made in the EVENT part.

Usage:

SCPI confirmed

STATus:PRESet <Preset>

The command resets the status registers. All PTRansition parts are set to FFFFh (32767), i.e. all transitions from 0 to 1 are detected. All NTRansition parts are set to 0, i.e. a transition from 1 to 0 in a CONDition bit is not detected. The ENABLE parts of STATus:OPERation and STATus:QUESTionable are set to 0, i.e. all events in these registers are not passed on.

Parameters:**<Preset>** string

Example: `STAT:PRES`
resets the status registers.

Usage: Event
SCPI confirmed

STATus:QUESTionable:CONDition? <Condition >

The command queries the content of the CONDition part of the STATus:QUESTionable register. This part contains information on the action currently being performed in the instrument. The content is not deleted after being read out since it indicates the current hardware status.

Parameters:
<Condition > string

Example: `STAT:OPER:COND`
queries the Status:Questionable:Condition register.

Usage: Query only
SCPI confirmed

STATus:QUESTionable:ENABLE <Enable>

The command sets the bits of the ENABLE part of the STATus:QUESTionable register. This setting determines which events of the Status-Event part are enabled for the sum bit in the status byte. These events can be used for a service request.

Parameters:
<Enable> string

Example: `STAT:OPER:ENAB 1`
problems when performing an adjustment cause an entry to be made in the sum bit.

Usage: SCPI confirmed

STATus:QUESTionable[:EVENT]? <EVENT>

The command queries the content of the EVENT part of the STATus:QUESTionable register. This part contains information on the actions performed in the instrument since the last readout. The content of the EVENT part is deleted after being read out.

Parameters:
<EVENT> string

Example: `STAT:QUES:EVEN?`
queries the Status:Questionable:Event register.

Usage: Query only
SCPI confirmed

STATus:QUEStionable:NTRansition <Ntransition>

The command sets the bits of the NTRansition part of the STATus:QUEStionable register. If a bit is set, a transition from 1 to 0 in the condition part causes an entry to be made in the EVENT part of the register.

Parameters:

<Ntransition> string

Example:

STAT:OPER:NTR 0

A transition from 1 to 0 in the condition part of the Status:Questionable register does not cause an entry to be made in the EVENT part.

Usage: SCPI confirmed

STATus:QUEStionable:PTRansition <Ptransition>

The command sets the bits of the PTRansition part of the STATus:QUEStionable register. If a bit is set, a transition from 1 to 0 in the condition part causes an entry to be made in the EVENT part of the register.

Parameters:

<Ptransition> string

Example:

STAT:OPER:PTR 32767

All transitions from 0 to 1 in the condition part of the Status:Questionable register cause an entry to be made in the EVENT part.

Usage: SCPI confirmed

STATus:QUEue[:NEXT]?

The command queries the oldest entry in the error queue and then deletes it. Positive error numbers denote device-specific errors, and negative error numbers denote error messages defined by SCPI. If the error queue is empty, 0 ("No error") is returned. The command is identical to `SYSTEM:ERROR?`

Return values:

<NEXT> string

Example:

STAT:QUE

queries the oldest entry in the error queue.

Response: 0, 'no error'

No errors have occurred since the error queue was last read out.

Usage: Query only
SCPI confirmed

7.14 SYSTEM Subsystem

The SYSTEM subsystem contains a series of commands for general functions which do not directly affect signal generation.

:SYSTEM:BEEPer:STATe.....	504
:SYSTEM:COMMunicate:GPIB:LTERminator.....	505
:SYSTEM:COMMunicate:GPIB[:SELF]:ADDRESS.....	505
:SYSTEM:COMMunicate:NETWork[:COMMOn]:DOMain.....	505
:SYSTEM:COMMunicate:NETWork[:COMMOn]:HOSTname.....	506
:SYSTEM:COMMunicate:NETWork[:COMMOn]:WORKgroup.....	506
:SYSTEM:COMMunicate:NETWork:IPADDRESS:MODE.....	506
:SYSTEM:COMMunicate:NETWork:IPADDRESS.....	507
:SYSTEM:COMMunicate:NETWork:IPADDRESS:GATeway.....	507
:SYSTEM:COMMunicate:NETWork:IPADDRESS:SUBNet:MASK.....	507
:SYSTEM:COMMunicate:NETWork:RESource.....	507
:SYSTEM:COMMunicate:USB:RESource.....	508
:SYSTEM:COMMunicate:GPIB:RESource.....	508
:SYSTEM:COMMunicate:SERial:RESource.....	508
:SYSTEM:COMMunicate:SERial:BAUD.....	508
:SYSTEM:COMMunicate:SERial:PARity.....	509
:SYSTEM:COMMunicate:SERial:SBITS.....	509
:SYSTEM:COMMunicate:SOCKEt:RESource.....	509
:SYSTEM:DATE.....	509
:SYSTEM:DISPlay:UPDate.....	510
:SYSTEM:DLOCK.....	510
SYSTEM:ERRor:ALL.....	510
SYSTEM:ERRor:CODE:ALL.....	511
SYSTEM:ERRor:CODE[:NEXT].....	511
SYSTEM:ERRor:COUNT.....	511
SYSTEM:ERRor[:NEXT].....	512
:SYSTEM:IDENtification.....	512
:SYSTEM:IRESpone.....	513
:SYSTEM:KLOCK.....	513
:SYSTEM:LANGuage.....	513
:SYSTEM:ORESpone.....	514
:SYSTEM:PROTect<ch>[:STATe].....	514
SYSTEM:SERRor.....	514
:SYSTEM:STARtup:COMPLete.....	515
:SYSTEM:TIME.....	515
SYSTEM:VERSion.....	515

:SYSTEM:BEEPer:STATe <State>

This command switches the key beep on or off.

Parameters:

<State> 0 | 1 | OFF | ON
 *RST: OFF

Example: `SYST:BEEP:STAT OFF`
No acoustic signal is output when a key on the front panel is pressed.

Usage: SCPI confirmed

:SYSTEM:COMMunicate:GPIB:LTERminator <Lterminator>

The command sets the terminator recognition for remote control via the IEC/IEEE bus.

Parameters:

<Lterminator> STANdard | EOI

EOI

The terminator must be sent together with the line message EOI (End of Line). This setting is recommended for binary block transmissions where a character could coincidentally have the value LF (Line Feed) but is not intended as the terminator. This setting must be selected for block data with undefined length.

STANdard

An LF (Line Feed) is recognized as the terminator regardless of whether it is sent with or without EOI.

*RST: STANdard

Example: `SYST:COMM:GPIB:LTER EOI`
only a character which is sent simultaneously with the line message EOI is accepted as the terminator.

:SYSTEM:COMMunicate:GPIB[:SELF]:ADDRess <Address>

The command sets the GPIB address.

Parameters:

<Address> float
Range: 1 to 30
*RST: 28

Example: `SYST:COMM:GPIB:ADDR 14`
sets GPIB address.

Usage: SCPI confirmed

:SYSTEM:COMMunicate:NETWork[:COMMON]:DOMain <Domain>

The command enters the domain of the network.

Parameters:

<Domain> string

Example: `SYST:COMM:NETW:COMM:DOM ABC.DE`
enters the domain of the network.

:SYSTem:COMMunicate:NETWork[:COMMON]:HOSTname <Hostname>

The command enters the individual computer name of the R&S Microwave Signal Generator. The entry is only activated after sending command

```
SYST:COMM:NETW:COMM:SET.
```

Note: The hostname can only be changed after deactivating protection level 1 (command SYSTem:PROTeCt<n>:STATe OFF, password)

Parameters:

<Hostname> string

Example:

```
SYST:COMM:NETW:HOST 'SIGGEN'
```

enters the individual computer name of the R&S Microwave Signal Generator.

Example:

```
SYST:COMM:NETW:COMM:SET ON
```

activates the change of the hostname.

:SYSTem:COMMunicate:NETWork[:COMMON]:WORKgroup <Workgroup>

The command enters the individual workgroup name of the instrument.

Parameters:

<Workgroup> string

Example:

```
SYST:COMM:NETW:COMM:WORK 'TEST_09'
```

enters the workgroup name 'TEST_09'.

:SYSTem:COMMunicate:NETWork:IPADdress:MODE <Mode>

The command selects if the IP address is assigned automatically or manually. The entry is only activated after sending command SYST:COMM:NETW:IPAD:SET.

Parameters:

<Mode> AUTO | STATic

AUTO

The IP address is assigned automatically. The network used must support automatic assignment of address (DHCP) in order to use this function.

STATic

The IP address is assigned manually.

```
*RST:        AUTO
```

Example:

```
SYST:COMM:NETW:IPAD:MODE AUTO
```

the IP address is assigned automatically (DHCP).

```
SYST:COMM:NETW:IPAD:SET ON
```

activates DHCP.

:SYSTEM:COMMunicate:NETWork:IPADdress <Ipaddress>

The command enters the IP address. The entry is only activated after sending command `SYST:COMM:NETW:IPAD:SET`.

Parameters:

<Ipaddress> string
Range: 0.0.0.0. to ff.ff.ff.ff

Example: `SYST:COMM:NETW:IPAD 7.8.9.10`
enters the IP address of the instrument.

Example: `SYST:COMM:NETW:IPAD:SET`
activates all changes of the IP address settings.

:SYSTEM:COMMunicate:NETWork[:IPADdress]:GATeway <Gateway>

The command enters the IP address of the default gateway. The entry is only activated after sending command `SYST:COMM:NETW:IPAD:SET`.

Parameters:

<Gateway> string
Range: 0.0.0.0 to ff.ff.ff.ff

Example: `SYST:COMM:NETW:GAT 1.2.3.4`
enters the IP address of the default gateway.

`SYST:COMM:NETW:IPAD:SET`
activates all changes of the IP address settings.

:SYSTEM:COMMunicate:NETWork[:IPADdress]:SUBNet:MASK <Mask>

The command enters the Subnet mask. The entry is only activated after sending command `SYST:COMM:NETW:IPAD:SET`.

Parameters:

<Mask> string

Example: `SYST:COMM:NETW:SUBN:MASK 255.255.0.0`
enters the Subnet mask.

`SYST:COMM:NETW:IPAD:SET`
activates all changes of the IP address settings.

:SYSTEM:COMMunicate:NETWork:RESource <Resource>

The command queries the visa resource string. This string is used for remote control of the instrument.

Parameters:

<Resource> string

Example: `SYST:COMM:NETW:RES`
 queries the VISA resource string.
 Response: `TCPIP::192.1.2.3::INSTR`

:SYSTEM:COMMunicate:USB:RESource?

The command queries the visa resource string for remote control via the USB interface.

Return values:

<Resource> string

Example: `SYST:COMM:USB:RES?`
 queries the VISA resource string for remote control via the USB interface.
 Response: `USB::72::000000::INSTR`

Usage: Query only

:SYSTEM:COMMunicate:GPIB:RESource?

The command queries the visa resource string for remote control via the GPIB interface. This string is used for remote control of the instrument.

To change the GPIB address, use the command `SYST:COMM:GPIB:ADDR`.

Return values:

<Resource> string

Example: `SYST:COMM:GPIB:RES`
 queries the VISA resource string.
 Response: `GPIB::28::INSTR`

Usage: Query only

:SYSTEM:COMMunicate:SERial:RESource?

The command queries the visa resource string for the serial remote control interface. This string is used for remote control of the instrument.

Return values:

<Resource> string

Example: `SYST:COMM:SER:RES`
 queries the VISA resource string.
 Response: `ASRL1::INSTR`

Usage: Query only

:SYSTEM:COMMunicate:SERial:BAUD <Baud>

The command enters the baudrate for the serial remote control interface.

Parameters:

<Baud> 2400 | 4800 | 9600 | 19200 | 38400 | 57600 | 115200
 *RST: 115200

Example:

SYST:COMM:SER:BAUD 115200
 enters the baudrate 115200.

:SYSTEM:COMMunicate:SERial:PARity <Parity>

The command enters the parity for the serial remote control interface.

Parameters:

<Parity> NONE | ODD | EVEN
 *RST: NONE

Example:

SYST:COMM:SER:PAR NONE
 selects parity NONE.

:SYSTEM:COMMunicate:SERial:SBITs <Sbits>

The command enters the number of stop bits for the serial remote control interface.

Parameters:

<Sbits> 1 | 2
 *RST: 1

Example:

SYST:COMM:SER:SBIT 2
 selects 2 stop bits.

:SYSTEM:COMMunicate:SOCKet:RESource?

The command queries the visa resource string for remote control via the Socket interface.

Return values:

<Resource> string

Example:

SYST:COMM:SOCK:RES?

Usage:

Query only

:SYSTEM:DATE <Date>

The command queries / sets the date for the instrument-internal calendar.

This parameter is protected, in order to prevent accidental changes. It can be accessed with protection level 1, see [:SYSTEM:PROTECT<ch>\[:STATe\]](#) on page 514.

Parameters:

<Date> <year>,<month>,<day>

Example:

SYST:DATE?
 Response: 2011,05,01 - it is the 1st of May in 2011.

:SYSTem:DISPlay:UPDate <Update>

The command switches the update of the display on/off. A switchover from remote control to manual control always sets the status of the update of the display to ON.

Parameters:

<Update> 0 | 1 | OFF | ON
 *RST: ON

Example:

SYST:DISP:UPD OFF
 switches update of displayed parameter values off.

:SYSTem:DLOCK <Dlock>

This command (**D**isplay **L**O**C**k) disables the manual operation via the display, or enables it again (OFF).

The command disables also the front panel keyboard of the instrument including the LOCAL key.

Parameters:

<Dlock> 0 | 1 | OFF | ON
 *RST: 0

Example:

SYST:DLOC ON
 activates the display lock. The instrument cannot be operated via the display until it has been enabled with SYST:DLOC OFF.

SYSTem:ERRor:ALL?

The command queries all entries in the error queue and then deletes them.

Parameters:

<All> string

0

"No error", i.e the error queue is empty.

positive value

Positive error numbers denote device-specific errors.

negative value

Negative error numbers denote error messages defined by SCPI

Example:

SYST:ERR:ALL?
 queries all entries in the error queue.
 Response: 0, 'no error'
 No errors have occurred since the error queue was last read out.

Usage:

Query only

SYSTem:ERRor:CODE:ALL?

The command queries all entries in the error queue and then deletes them. Only the error numbers are returned and not the entire error text.

Return values:

<All> string

0

"No error", i.e. the error queue is empty

positive value

Positive error numbers denote device-specific errors

negative value

Negative error numbers denote error messages defined by SCPI.

Example:

SYST:ERR:CODE:ALL

queries all entries in the error queue.

Response: 0

no errors have occurred since the error queue was last read out.

Usage:

Query only

SYSTem:ERRor:CODE[:NEXT]?

The command queries the oldest entry in the error queue and then deletes it. Only the error number is returned and not the entire error text.

Return values:

<Next> string

0

"No error", i.e. the error queue is empty

positive value

Positive error numbers denote device-specific errors

negative value

Negative error numbers denote error messages defined by SCPI.

Example:

SYST:ERR:CODE

queries the oldest entry in the error queue.

Response: 0

No errors have occurred since the error queue was last read out.

Usage:

Query only

SYSTem:ERRor:COUNT?

The command queries the number of entries in the error queue. If the error queue is empty, '0' is returned.

Return values:

<Count> string

Example: `SYST:ERR:COUN`
 queries the number of entries in the error queue.
 Response: 1
 One error has occurred since the error queue was last read out.

Usage: Query only

SYSTem:ERRor[:NEXT]?

The command queries the oldest entry in the error queue and then deletes it.

The command is identical to the command `STATus:QUEue:NEXT`.

Return values:

<Next> string

0
 "No error", i.e. the error queue is empty

positive value
 Positive error numbers denote device-specific errors

negative value
 Negative error numbers denote error messages defined by SCPI.

Example: `SYST:ERR?`
 queries the oldest entry in the error queue.
 Response: 0, 'no error'
 No errors have occurred since the error queue was last read out.

Usage: Query only

:SYSTem:IDENtification <Identification>

Enables/disables selection of user defined "IDN String" and "OPT String" for the selected instrument (`:SYST:LANG`).

Note: While working in a emulation mode, the R&S SMF specific command set is disabled, i.e. the SCPI command `SYST:IDEN` will be discarded.

Parameters:

<Identification> `AUTO | USER`
 *RST: `AUTO`

Example: `SYST:IDEN USER`
 selects the user defined identification string.
`SYST:IRES "Test Device"`
 defines the identification string 'test device'
`*IDN?`
 Response: 'test device'
`SYST:LANG 'HP8373'`
 selects command set of the HP generator. The R&S SMF's command set is disabled.
 To return to the SCPI command set of the R&S SMF, use the HP command `EX`.

:SYSTEM:IRESpOse <Iresponse>

The command defines the identification string for selection user defined (SYST:IDEN USER).

Note: While working in a emulation mode, the instrument's specific command set is disabled, i.e. the SCPI command SYST:IRES will be discarded.

Parameters:

<Iresponse> string

Example:

```
SYST:IDEN USER
selects an user-defined identification
SYST:IRES "Test Device"
defines the identification string 'test device'
*IDN?
Response: 'test device'
```

:SYSTEM:KLOCK <Klock>

This command (**Keyboard LOCK**) disables the front panel keyboard of the instrument including the LOCAL key, or enables it again (OFF).

Parameters:

<Klock> 0 | 1 | OFF | ON
*RST: OFF

Example:

```
SYST:KLOC ON
activates the keyboard lock. The keyboard cannot be operated
again until it has been enabled with SYST:KLOC OFF.
```

:SYSTEM:LANGUage <Language>

The command selects the command set to be used. The GPIB command set of the R&S SMF no longer works after the selection of one of the HP generator command sets. See Application Note 1G71 on the user documentation CD-ROM (included in delivery).

The HP command EX returns to the instrument-specific GPIB command set.

Note: Selecting a command set automatically activates the use of the identification string of the associated instrument.

While working in a emulation mode, the instrument's specific command set is disabled, i.e. the SCPI command SYST:LANG will be discarded.

Parameters:

<Language> string
*RST: SCPI

Example:

```
SYST:LANG 'HP8373'
selects command set of the HP generator.
```

:SYSTEM:ORESpOse <Oresponse>

The command defines the OPT string for selection user defined (SYST:IDEN USER).

Note: While working in a emulation mode, the instrument's specific command set is disabled, i.e. the SCPI command SYST:ORES will be discarded.

Parameters:

<Oresponse> string

Example:

```
SYST:IDEN USER
selects an user-defined identification
SYST:ORES "Test Option"
defines the OPT string 'test option'
*OPT?
Response: 'test option'
```

:SYSTEM:PROTect<ch>[:STATe] <State>,<password>

The command activates and deactivates the specified protection level.

Suffix:

<ch> Indicates the protection level.
There are several protection levels which disable specific service functions (authorized personnel of R&S Service Departments only).

Parameters:

<State> 0 | 1 | OFF | ON

<password> The respective functions are disabled when the protection level is activated. No password is required for activation. A password must be entered to deactivate the protection level. The password for the first level is 123456. This protection level can be used to lock-out internal adjustments.

Example:

```
SYST:PROT1 ON
activates protection level 1. Internal adjustments are only possible
after deactivating the lock-out.
SYST:PROT1 OFF, 123456
deactivates protection level 1. Internal adjustments are enabled
again.
```

Usage: SCPI confirmed

SYSTEM:SERRor?

This command returns a list of all errors existing at the time when the query is started. This list corresponds to the display on the info page under manual control.

Return values:

<Serror> string

Example: `SYST:SErr`
queries all errors existing in the error queue.

Example: Response: -221, 'Settings conflict', 153, 'Input voltage out of range'
The two returned errors have occurred since the error queue was last queried.

Usage: Query only

:SYSTem:STARtup:COMPLete?

The command queries if the startup of the instrument is completed.

Return values:

<Complete> 0 | 1 | OFF | ON
*RST: 0

Example: `SYST:STAR:COMP`
Response: 1
The startup of the instrument is completed.

Usage: Query only

:SYSTem:TIME <Time>

The command queries / sets the time for the instrument-internal clock.

The parameter is protected, in order to prevent accidental changes. It can be accessed with protection level 1, see `:SYSTem:PROTECT<ch>[:STATe]` on page 514.

Parameters:

<Time> 0...23,0...59,0...59

Example: `SYST:TIME?`
Response: 12, 0, 0 it is precisely 12 pm.

SYSTem:VERSion?

The command queries the SCPI version with which the instrument complies.

Return values:

<Version> string

Example: `SYST:VERS`
queries the SCPI version.
Response: 1996
The instrument complies with the version from 1996.

Usage: Query only

7.15 TEST Subsystem

The TEST system contains the commands for performing the routines as well as for direct manipulation of the hardware assemblies (:TEST:DIReCt).

The self tests return a "0" if the test is performed successfully, otherwise a value other than "0" is returned. None of the commands of this system have an *RST value.

NOTICE

Improper use may destroy the assembly!

The respective hardware assembly responds directly to the :TEST:DIReCt command; any safety mechanisms are bypassed. The command is used for servicing purposes and should not be applied by the user.

:TEST<hw>:DIReCt.....516

:TEST<hw>:DIReCt <HW_assembly>,<subaddress>,<hex data string>

:TEST<hw>:DIReCt? <HW_assembly>,<subaddress>

The respective hardware assembly responds directly to the command; any safety mechanisms are bypassed. This function is only available via remote control.

Example: TEST:DIR 'SSYN',0,#H12345678
 TEST:DIR? 'SSYN',0
 Response: #H12345678

7.16 TRIGger Subsystem

The TRIGger system contains the commands for selecting the trigger source for the RF and LF sweep. The trigger input connectors are configured in the SOURce:INPut subsystem.

The trigger system of the R&S SMF is a simplified implementation of the SCPI trigger system. The TRIGger system differs from the SCPI system as follows:

- No INITiate command; the instrument behaves as if INITiate:CONTinuous ON were set.
- Under TRIGger several sweep subsystems exist.

Other commands associated with the trigger system of the R&S SMF can be found in the modulation and RF signal subsystems.

TRIGger<hw>

- Suffix TRIGger<1|2> is not permitted

Table 7-2: Cross-reference between the manual and remote control

R&S name	SCPI name	Command under manual control
AUTO	IMMediate	"Auto" mode
SINGle	BUS	"Single" mode.
EXTernal	EXTernal	"Ext Single" and "Ext Step" mode. Use com- mand :SWEep:FREQ:MODE to select between the two sweep modes.
EAuto	-	"Ext Start/Stop" mode.

:TRIGger<hw>:LFFSweep:SOURce.....	517
:TRIGger<hw>:FSWweep[:IMMediate].....	518
:TRIGger<hw>:FSWweep:SOURce.....	518
:TRIGger<hw>:LFVSweep:SOURce.....	519
:TRIGger<hw>:PSWweep[:IMMediate].....	520
:TRIGger<hw>:PSWweep:SOURce.....	520
:TRIGger<hw>[:SWEep][:IMMediate].....	521
:TRIGger<hw>[:SWEep]:SOURce.....	521

:TRIGger<hw>:LFFSweep:SOURce <Source>

The command sets the trigger source for the LF sweep. The trigger is triggered by the command :SOURce:LFOutput:SWEep[:FREQuency]EXECute.

The names of the parameters correspond directly to the various settings under manual control. SCPI uses other names for the parameters; these names are also accepted by the instrument. The SCPI names should be used if compatibility is an important consideration.

An overview of the various names is given in the [table 7-2](#).

Parameters:

<Source>

AUTO | IMMEDIATE | SINGLE | BUS | EXTERNAL | EAUTO

AUTO|IMMEDIATE

The trigger is free-running, i.e. the trigger condition is fulfilled continuously. As soon as one sweep is finished, the next sweep is started.

SINGLE|BUS

One complete sweep cycle is triggered by the GPIB commands `[:SOURCE] :LFOutput :SWEep [:FREQuency] :EXECute` or `*TRG`.

The mode has to be set to AUTO (`[:SOURCE] :LFOutput :SWEep [:FREQuency] :MODE`).

EXTERNAL

The sweep is triggered externally via the TRIGGER connector or the AUX connector at the rear of the instrument.

EAUTO

The sweep is triggered externally via the INST TRIG connector. As soon as one sweep is finished, the next sweep is started. A second trigger event stops the sweep at the current frequency, a third trigger event starts the trigger at the start frequency, and so on.

*RST: SINGLE

Example:

```
TRIG:LFFS:SOUR EXT
```

selects triggering with an external trigger.

:TRIGger<hw>:FSWeep[:IMMEDIATE]

The command immediately starts an RF frequency sweep cycle.

The command is only effective for sweep mode "Single" (`SOUR :SWE :FREQ :MODE AUTO` in combination with `TRIG :FSW :SOUR SING`).

The command corresponds to the manual control "Execute Single Sweep".

Example:

```
SWE:FREQ:MODE AUTO
```

sets the triggered sweep mode, i.e. a trigger is required to start the sweep.

```
TRIG:FSW:SOUR SING
```

sets the "Single" trigger mode, i.e. a trigger starts a single sweep.

```
TRIG:FSW
```

starts a single RF frequency sweep.

Usage:

Event

:TRIGger<hw>:FSWeep:SOURce <Source>

The command sets the trigger source for the RF frequency sweep.

The names of the parameters correspond directly to the various settings under manual control. SCPI uses other names for the parameters; these names are also accepted by the instrument. The SCPI names should be used if compatibility is an important consideration.

An overview of the various names is given in [table 7-2](#).

Parameters:

<Source>

AUTO | IMMEDIATE | SINGLE | BUS | EXTERNAL | EAUTO

AUTO|IMMEDIATE

The trigger is free-running, i.e. the trigger condition is fulfilled continuously. As soon as one sweep is finished, the next sweep is started.

SINGLE|BUS

One complete sweep cycle is triggered by the GPIB commands `[:SOURCE<hw>] :SWEep [:FREQuency] :EXECute, : TRIGger<hw> :FSWEEP [:IMMEDIATE]` or `*TRG`. The mode has to be set to AUTO (`:SOURCE:SWEep:FREQuency:MODE AUTO`).

EXTERNAL

The sweep is triggered externally via the TRIGGER connector or the AUX connector at the rear of the instrument.

EAUTO

The sweep is triggered externally via the INST TRIG connector. As soon as one sweep is finished, the next sweep is started. A second trigger event stops the sweep at the current frequency, a third trigger event starts the trigger at the start frequency, and so on.

*RST: SINGLE

Example:

`TRIG:FSW:SOUR EXT`

selects triggering with an external trigger.

:TRIGger<hw>:LFVSweep:SOURce <Source>

The command sets the trigger source for the LF level sweep.

The names of the parameters correspond directly to the various settings under manual control. SCPI uses other names for the parameters; these names are also accepted by the instrument. The SCPI names should be used if compatibility is an important consideration.

An overview of the various names is given in the [table 7-2](#).

Parameters:

<Source>

AUTO | IMMEDIATE | SINGLE | BUS | EXTERNAL

AUTO | IMMEDIATE

The trigger is free-running, i.e. the trigger condition is fulfilled continuously. As soon as one sweep is finished, the next sweep is started.

SINGLE

One complete sweep cycle is triggered by the GPIB bus commands [:SOURce]:LFOutput:SWEep:VOLTage:EXECute or *TRG. The mode has to be set to "AUTO" (:SOURce:LFOutput:SWEep:VOLTage:MODE AUTO).

EXTERNAL

The sweep is triggered externally via the TRIGGER connector or the AUX connector at the rear of the instrument.

*RST: SINGLE

Example:

TRIG:LFVS:SOUR EXT

selects triggering with an external trigger. The trigger is input via the TRIGGER connector or the AUX connector at the rear of the instrument.

:TRIGger<hw>:PSWeep[:IMMEDIATE]

The command immediately starts an RF level sweep.

The command is only effective for sweep mode "Single" (SOURce:SWEep:POWer:MODE AUTO in combination with TRIG:PSW:SOUR SING).

The command corresponds to the manual control "Execute Single Sweep".

Example:

SWE:POW:MODE AUTO

selects the triggered sweep mode, i.e. a trigger is required to start the sweep.

TRIG:PSW:SOUR AUTO

sets the Single trigger mode, i.e. a trigger starts a single sweep.

TRIG:PSW

starts a single RF level sweep.

Usage:

Event

:TRIGger<hw>:PSWeep:SOURce <Source>

The command sets the trigger source for the RF level sweep.

The names of the parameters correspond directly to the various settings under manual control. SCPI uses other names for the parameters; these names are also accepted by the instrument. The SCPI names should be used if compatibility is an important consideration.

An overview of the various names is given in [table 7-2](#).

Parameters:

<Source>

AUTO | IMMEDIATE | SINGLE | BUS | EXTERNAL | EAUTO

AUTO|IMMEDIATE

The trigger is free-running, i.e. the trigger condition is fulfilled continuously. As soon as one sweep is finished, the next sweep is started.

SINGLE|BUS

One complete sweep cycle is triggered by the GPIB commands `[:SOURCE<hw>] :SWEep:POWer:EXECute, :TRIGger<hw>:PSWep [:IMMEDIATE]` or `*TRG`. The mode has to be set to AUTO (`:SOURCE:SWEep:LEVel:MODE AUTO`).

EXTERNAL

The sweep is triggered externally via the TRIGGER connector or the AUX connector.

EAUTO

The sweep is triggered externally via the INST TRIG connector. As soon as one sweep is finished, the next sweep is started. A second trigger event stops the sweep at the current frequency, a third trigger event starts the trigger at the start frequency, and so on.

*RST: SINGLE

Example:

TRIG:PSW:SOUR EXT

selects triggering with an external trigger.

:TRIGger<hw>[:SWEep][:IMMEDIATE]

The command starts all sweeps which are activated for the respective path. The command starts all sweeps which are activated.

The sweep to be executed depends on the respective MODE setting (`:SOUR:SWEep:POW|FREQ:MODE` and `:SOUR:LFO:SWEep[:FREQ]:MODE`).

The command corresponds to the manual-control command "Execute Trigger".

Example:

TRIG

starts all active sweeps.

Usage:

Event

:TRIGger<hw>[:SWEep]:SOURCE <Source>

The command sets the trigger source for all sweeps.

The names of the parameters correspond directly to the various settings under manual control. SCPI uses other names for the parameters; these names are also accepted by the instrument. The SCPI names should be used if compatibility is an important consideration.

An overview of the various names is given in the [table 7-2](#).

Parameters:

<Source>

AUTO | IMMEDIATE | SINGLE | BUS | EXTERNAL | EAUTO

AUTO|IMMEDIATE

The trigger is free-running, i.e. the trigger condition is fulfilled continuously. As soon as one sweep is finished, the next sweep is started.

SINGLE|BUS

One complete sweep cycle is triggered by the GPIB commands :SOURCE:SWEEP:POWER|FREQUENCY:EXEC, TRIGGER:PSWEEP|FSWEEP:IMMEDIATE or *TRG.

If :SOURCE:SWEEP:POWER:MODE is set to STEP, one step is executed.

The mode has to be set to AUTO.

EXTERNAL

The sweep is triggered externally via the INST TRIG connector.

EAUTO

The sweep is triggered externally via the INST TRIG connector. As soon as one sweep is finished, the next sweep is started. A second trigger event stops the sweep at the current frequency, a third trigger event starts the trigger at the start frequency, and so on.

*RST: SINGLE

Example:

```
TRIG0:SOUR EXT
```

selects triggering with an external trigger. The trigger is input via the INST TRIG connector.

Usage:

Setting only

7.17 UNIT Subsystem

The UNIT subsystem contains the commands specifying which units are valid if no unit is indicated in a command. These settings are valid for the entire instrument.

:UNIT:ANGLE <Angle>

The command defines the default unit for the phase modulation angle. It is not valid for other commands which determine angle values, e.g. RF phase. It does not influence the manual control parameter unit and the display.

Parameters:

<Angle>

DEGREE | DEGREE | RADIAN

*RST: RADIAn

Example:

```
UNIT:ANGL DEG
```

sets default unit DEG for all commands which determine angle values.

:UNIT:POWer <Power>

The command defines the default unit for power. It is valid for all commands which determine power values. It does not influence the manual control parameter unit and the display.

Parameters:

<Power> V | DBUV | DBM
*RST: DBM

Example:

UNIT:POW V
sets default unit V for all commands which determine power values.

8 Maintenance

The instrument does not need periodic maintenance. Only the cleaning of the instrument is essential. The outside of the instrument is suitably cleaned using a soft, line-free dust cloth. Make sure that the air vents are not obstructed.

WARNING

Shock hazard

Before cleaning the instrument, make sure that the instrument is switched off and disconnected from all power supplies.

NOTICE

Instrument damage caused by cleaning agents

Cleaning agents contain substances that may damage the instrument, e.g. cleaning agents that contain a solvent may damage the front panel labeling or plastic parts.

Never use cleaning agents such as solvents (thinners, acetone, etc), acids, bases, or other substances.

The outside of the instrument can be cleaned sufficiently using a soft, lint-free dust cloth.

Follow the instructions in the service manual and the safety instructions when exchanging modules or ordering spares. The order no. for spare parts is included in the service manual. The service manual includes further information particularly on troubleshooting, repair, exchange of modules and alignment.

The address of our support center and a list of all Rohde & Schwarz service centers can be found at the beginning of this manual.

8.1 Storing and Packing

The storage temperature range of the instrument is given in the data sheet. If the instrument is to be stored for a longer period of time, it must be protected against dust.

Repack the instrument as it was originally packed when transporting or shipping. The two protective foam plastic parts prevent the control elements and connectors from being damaged. The antistatic packing foil avoids any undesired electrostatic charging to occur.

If you do not use the original packaging, use a sturdy cardboard box of suitable size and provide for sufficient padding to prevent the instrument from slipping inside the package. Wrap antistatic packing foil around the instrument to protect it from electrostatic charging.

9 Error Messages

This chapter describes the error messages of the R&S SMF. The error messages are output in the "Info" line on the screen and entered in the error/event queue of the status reporting system.

A great variety of different messages such as status messages, error messages, warnings or information are displayed in the header field of the screen. Some error messages require that the error must be eliminated before correct instrument operation can be ensured. The info window with a list of current messages and a detailed description of each message can be opened with the INFO key.

In the remote control mode, error messages are entered in the error/event queue of the status reporting system and can be queried with the command `SYSTEM:ERROR?`. If the error queue is empty, 0 ("No error") is returned.

9.1 Status Information

The status messages are displayed in the header section of the screen. The status information gives the user an overview of the main operating states and settings of the instrument. The states are indicated for information only and do not necessitate any action by the user. Status information is displayed between the frequency and level fields, at the left of the info line or in the info line itself.

9.1.1 Status information displayed between the frequency and level fields

This chapter gives an overview of the status messages displayed between the frequency and level fields.

RF OFF

The RF output is switched off

MOD OFF

All modulations are switched off

FREQ OFFSET

A frequency offset is set.

The frequency entered and displayed in the "Frequency" field takes any set frequency offset into consideration, e.g. an offset set for a downstream instrument. This means that with a frequency offset the frequency displayed in the header does not correspond to the frequency at the RF output, but rather to the frequency at the output of the downstream instrument.

This allows the target frequency at the output of a downstream instrument to be entered in the frequency field. The signal generator changes the RF output frequency according to the entered offset.

However, the frequency entered and displayed in the "Frequency/Phase" dialog of the "RF" function block always corresponds to the RF output frequency. Any frequency offset is not taken into consideration.

The correlation is as follows:

Freq in header = RF output frequency (= Freq in dialog) + Freq offset (= Offset in dialog)

LEVEL OFFSET

A level offset is set.

The level entered and displayed in the "Level" field takes the offset of any downstream attenuators/amplifiers into consideration by way of calculation. This means that with a level offset the level displayed in the header does not correspond to the level at the RF output, but rather to the level at the output of the downstream instrument.

This allows the target level at the output of downstream instruments to be entered. The signal generator changes the RF output level according to the set offset.

However, the level entered and displayed in the "Level" dialog of the "RF" function block always corresponds to the RF output level. Any level offset is not taken into consideration.

The correlation is as follows:

Level in header = RF output level (= Level in dialog) + Level offset

EXT REF

An external reference is used.

The external signal with selectable frequency and defined level must be input at the REF IN connector. It is output at the REF OUT connector.

BUSY

A setting or calculation is executed.

9.1.2 Status information displayed to the left of the Info line

This chapter gives an overview of the status messages displayed to the left of the Info line.

REMOTE

The instrument is remote controlled.

The keys on the front panel are usable, but all parameters are in read only mode.

The LOCAL key switches the instrument from remote control to manual operation. The current command must be fully processed before the mode is switched, otherwise the instrument switches immediately back to remote control.

REM-LLO

The instrument is remote (**REM**ote) controlled. The LOCAL key is disabled by remote control with the command `LLO` (**L**ocal**L**ock**O**ut).

The keys on the front panel are usable, but all parameters are in read only mode.

The instrument can be switched from remote control to manual operation by means of remote control only (e.g. with the Visual Basic command `CALL IBLOC (generator%)` or by `&NREN`).

LOC-LLO

For operating directly the instrument is placed from remote control to manual operation (Local State). The LOCAL key was disabled by remote control with the command `LLO (LocalLockOut)`.

With the next activating of the remote control mode, the instrument cannot be switched to manual operation by the operator. The status information changes to "REM-LLO".

The instrument can be switched to manual operation by means of remote control only (e.g. with the Visual Basic command `CALL IBLOC (generator%)`).

9.1.3 Status information displayed in the Info line

This chapter gives an overview of the status messages displayed in the Info line.

RFSweep / LevelSweep / LFSweep

The indicated sweep is enabled.

ALC On / Auto / S&H

The status of the automatic level control is indicated:

- ON
automatic level control permanently on
- Auto
automatic level control is automatically adapted to the operating states
- S&H
automatic level control off, recalibration of the level whenever the level or frequency is set (sample and hold mode)

ListMode

List mode is active.

The values of the frequency/level pairs in the selected list are set for the chosen dwell time.

AttFixed

Attenuator fixed mode is active.

The uninterrupted level settings are made in a fixed range without attenuator switching. The variation range is set automatically when this mode is activated. The range is displayed under "Attenuator Fixed Range" in the "Level" dialog.

UCorr

User Correction is active.

The level is corrected by the given values in the selected user correction list. Correction is performed by the user-defined list values being added to the output level for the respective RF frequency. With frequencies which are not contained in the list, the level correction is determined by interpolation of the closest correction values.

OvenCold

The reference oscillator has not yet reached its nominal frequency.

When switching on from the STANDBY mode, the specified frequency accuracy is reached immediately. If the power switch was switched off, the reference oscillator needs some warm-up time to reach its nominal frequency. During this period of time, the output frequency does not yet reach its final value either.

9.2 Error Messages

Messages indicate errors in the instrument. They are displayed in the info line in different colors depending on their importance and display duration. Errors (e.g. no calibration data) are displayed in red, information (e.g. file not found) and warnings in black. Warnings indicate less significant errors (e.g. the instrument operates outside specified data).

9.2.1 Volatile messages

Volatile messages report automatic settings in the instrument (e.g. switching off of incompatible types of modulation) or on illegal entries that are not accepted by the instrument (e.g. range violations). They are displayed in the info line on a yellow background. They are displayed on top of status information or permanent messages.

Volatile messages do not normally demand user actions and disappear automatically after a brief period of time. They are stored in the history, however.

SCPI command: `SYSTem:ERRor:ALL` or `SYSTem:ERRor[:NEXT]`

9.2.2 Permanent messages

Permanent messages are displayed if an error occurs that impairs further instrument operation, e.g. a hardware fault. The error signaled by a permanent message must be eliminated before correct instrument operation can be ensured.

The message is displayed until the error is eliminated. It covers the status display in the info line. After error elimination, the message automatically disappears and is also recorded in the history.

SCPI command: `SYSTem:SERRor`

9.3 SCPI-Error Messages

The SCPI error messages are the same in all SCPI instruments. Detailed information and an overview of all error messages as defined in SCPI standard can be found in the corresponding documentation.

The errors are assigned negative numbers. The error text being entered into the error/event queue or being displayed is printed in bold face on the left together with the error code. Below the error text, there is an explanation as to the respective error.

9.4 Device-Specific Error Messages

The following table contains all error messages specific for the instrument in alphabetical order, as well as an explanation of the error situation. The positive error codes mark the errors specific of the instrument.

The device-specific error messages set bit 3 in the ESR register.



The index provides a list of the error messages sorted according to their error codes.

Error Code	Error	Description	Remedy
50	Extern reference out of range or disconnected	External reference is selected but no external signal is applied or the signal is out of range.	<ul style="list-style-type: none"> Check the selected reference signal source (internal or external) in the "Setup > Reference Oscillator" dialog. Change setting to 'internal' if no appropriate external source is available.
140	This modulation forces other modulations off	A modulation has been switched on which cannot be used at the same time as an already active modulation. The previous modulation has been switched off. Example: Enabling FM modulation switches PM modulation off.	
180	Adjustment failed	Adjustment could not be executed	The adjustment data have to be generated first by an internal or external adjustment or to be loaded into the device (see chapter 5.2.3.1, "Internal Adjustments" , on page 90).
182	Adjustment data missing	Adjustment data are missing.	The adjustment data have to be generated first by an internal or external adjustment or to be loaded into the instrument.
183	Adjustment data invalid	Adjustment data are invalid and must be restored.	The adjustment data have to be generated again by an internal or external adjustment or to be loaded into the instrument.
200	Cannot access hardware	The data transmission to a module was unsuccessful.	The module is not installed, not properly installed or missing.

Error Code	Error	Description	Remedy
201	Hardware revision out of date	A later version of certain parts of the instrument is necessary to execute the function selected.	The driver does not support the installed version of a module.
202	Cannot access the EEPROM	A error occurs when writing or reading a EEPROM.	The EEPROM might be defect and has to be replaced.
203	Invalid EEPROM data	Reading a EEPROM is possible, however the data are inconsistent.	
204	Driver initialization failed	Initialization of a driver fails when booting the instrument firmware.	The driver is not compatible with the hardware or software configuration of the instrument.
241	No current list	There is no list selected. To execute the required operation, a list has to be selected in the related menu.	If no list is available, a new list must be created.
242	Unknown list type specified	The list type selected is not valid for the required operation. For instance, the file extension for waveform list files is *.wv. It is not possible to enter another file extension when selecting a list.	Check the selected list type.
460	Cannot open file	The selected file can not be opened.	Check the path and file name.
461	Cannot write file	The file can not be written.	Check if the file is read-only.
462	Cannot read file	The file can not be read.	Check if the file contents are compatible with the file type.
463	Filename missing	The required operation cannot be executed because the file name is not specified.	A file name has to be entered when creating a new list.
464	Invalid filename extension	The file extension is not valid for the required operation.	Check the file extension. For instance, the file extension for waveform list files is *.wv. It is not possible to enter another file extension when storing a list.
465	File contains invalid data	The selected file contains data that is not valid for the file type. The file extension determines the data that is valid for this file type. If the file extension is changed the lists are no longer recognized and the data are therefore invalid. Example: the extension of a waveform file (= *.wv) was changed to *.txt	Check the file extension.

A Hardware Interfaces

This section covers hardware related topics, like pin assignment of the GPIB bus interface.

The remote control interfaces are described in details in [chapter 6, "Remote Control Basics"](#), on page 265.

All other interfaces are described in [chapter 2.1, "Front Panel Tour"](#), on page 15 and [chapter 2.2, "Rear Panel Tour"](#), on page 22.

For specifications refer to the data sheet.

A.1 GPIB Bus Interface

Pin assignment

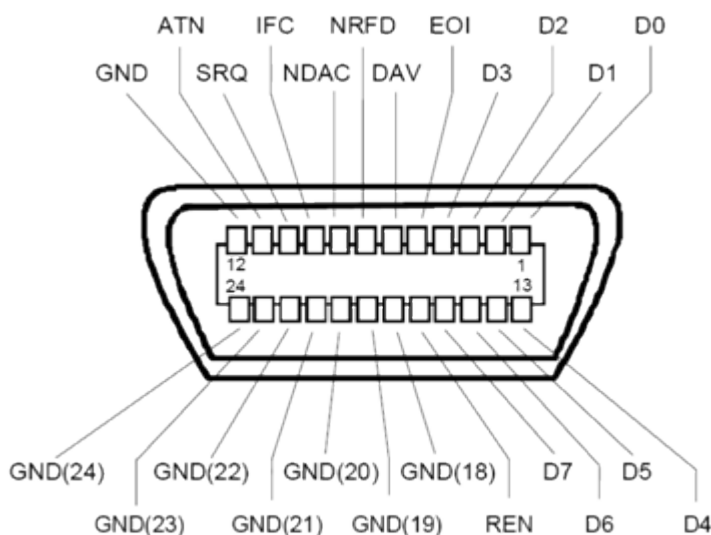

Fig. 1-1: Pin assignment of GPIB bus interface

Bus lines

- Data bus with 8 lines D0 to D7:
The transmission is bit-parallel and byte-serial in the ASCII/ISO code. D0 is the least significant bit, D7 the most significant bit.
- Control bus with five lines:
IFC (Interface Clear): active LOW resets the interfaces of the instruments connected to the default setting.
ATN (Attention): active LOW signals the transmission of interface messages, inactive HIGH signals the transmission of device messages.

SRQ (Service Request): active LOW enables the connected device to send a service request to the controller.

REN (Remote Enable): active LOW permits switchover to remote control.

EOI (End or Identify): has two functions in connection with ATN:

- ATN=HIGH active LOW marks the end of data transmission.
- ATN=LOW active LOW triggers a parallel poll.

- Handshake bus with three lines:

DAV (Data Valid): active LOW signals a valid data byte on the data bus.

NRFD (Not Ready For Data): active LOW signals that one of the connected devices is not ready for data transfer.

NDAC (Not Data Accepted): active LOW signals that the instrument connected is accepting the data on the data bus.

Interface Functions

Instruments which can be controlled via GPIB bus can be equipped with different interface functions. The interface function for the R&S SMF are listed in the following table.

Table 1-1: GPIB bus interface functions

Control character	Interface function
SH1	Handshake source function (source handshake), full capability
AH1	Handshake sink function (acceptor handshake), full capability
L4	Listener function, full capability, de-addressed by MTA.
T6	Talker function, full capability, ability to respond to serial poll, deaddressed by MLA
SR1	Service request function (Service Request), full capability
PP1	Parallel poll function, full capability
RL1	Remote/Local switch over function, full capability
DC1	Reset function (Device Clear), full capability
DT1	Trigger function (Device Trigger), full capability

List of Commands

[:SOURce<hw>]:PULM:SYNC.....	473
*CAL.....	305
*CLS.....	305
*ESE.....	306
*ESR.....	306
*IDN.....	306
*IST.....	306
*OPC.....	307
*OPT.....	307
*PCB.....	307
*PRE.....	307
*PSC.....	307
*RCL.....	308
*RST.....	308
*SAV.....	308
*SRE.....	308
*STB.....	309
*TRG.....	309
*TST.....	309
*WAI.....	309
:CALCulate[:POWer]:SWEep:FREQuency:MATH<ch>:STATe.....	339
:CALCulate[:POWer]:SWEep:FREQuency:MATH<ch>:SUBTract.....	339
:CALCulate[:POWer]:SWEep:POWer:MATH<ch>:STATe.....	340
:CALCulate[:POWer]:SWEep:POWer:MATH<ch>:SUBTract.....	340
:CALCulate[:POWer]:SWEep:TIME:GATE<ch>:FEED.....	338
:CALCulate[:POWer]:SWEep:TIME:GATE<ch>:STATe.....	339
:CALCulate[:POWer]:SWEep:TIME:GATE<ch>:AVERAge.....	337
:CALCulate[:POWer]:SWEep:TIME:GATE<ch>:MAXimum.....	338
:CALCulate[:POWer]:SWEep:TIME:GATE<ch>:START.....	339
:CALCulate[:POWer]:SWEep:TIME:MATH<ch>:STATe.....	340
:CALCulate[:POWer]:SWEep:TIME:MATH<ch>:SUBTract.....	341
:CALibration:ALL[:MEASure].....	311
:CALibration:LFOutput[:MEASure].....	313
:CALibration<hw>:FREQuency[:MEASure].....	312
:CALibration<hw>:LEVel:EXTErn:DATA.....	312
:CALibration<hw>:LEVel:LOOPgain:STATe.....	312
:CALibration<hw>:LEVel:STATe.....	313
:CALibration<hw>:LEVel[:MEASure].....	312
:DEvice:PRESet.....	310
:DIAGnostic:INFO:OTIME.....	314
:DIAGnostic:INFO:POCount.....	314
:DIAGnostic<hw>:BGInfo.....	313
:DIAGnostic<hw>:BGInfo:CATalog.....	314
:DISPlay:PSAVe:HOLDoff.....	315
:DISPlay:PSAVe[:STATe].....	315

:DISPlay[:WINDow][:POWer]:SWEep:BACKground:COLor.....	341
:DISPlay[:WINDow][:POWer]:SWEep:GRID:STATe.....	341
:FORMat:BORDER.....	316
:FORMat:SREGister.....	317
:FORMat[:DATA].....	316
:HCOPy:DATA.....	318
:HCOPy:DEVice.....	318
:HCOPy:DEVice:LANGUage.....	318
:HCOPy:FILE[:NAME].....	319
:HCOPy:FILE[:NAME]:AUTO.....	319
:HCOPy:FILE[:NAME]:AUTO:DIRectory.....	319
:HCOPy:FILE[:NAME]:AUTO:DIRectory:CLear.....	320
:HCOPy:FILE[:NAME]:AUTO:FILE.....	320
:HCOPy:FILE[:NAME]:AUTO:STATe.....	323
:HCOPy:FILE[:NAME]:AUTO[:FILE]:DAY.....	320
:HCOPy:FILE[:NAME]:AUTO[:FILE]:DAY:STATe.....	321
:HCOPy:FILE[:NAME]:AUTO[:FILE]:MONTH.....	321
:HCOPy:FILE[:NAME]:AUTO[:FILE]:MONTH:STATe.....	321
:HCOPy:FILE[:NAME]:AUTO[:FILE]:NUMBER.....	321
:HCOPy:FILE[:NAME]:AUTO[:FILE]:PREFix.....	322
:HCOPy:FILE[:NAME]:AUTO[:FILE]:PREFix:STATe.....	322
:HCOPy:FILE[:NAME]:AUTO[:FILE]:YEAR.....	322
:HCOPy:FILE[:NAME]:AUTO[:FILE]:YEAR:STATe.....	323
:HCOPy:IMAGe:FORMat.....	323
:HCOPy:IMAGe:SIZE.....	323
:HCOPy[:EXECute].....	318
:INITiate<ch>[:POWer]:CONTInuous.....	342
:KBOard:LANGUage.....	324
:KBOard:LAYout.....	324
:MMEMory:CATalog.....	328
:MMEMory:CATalog:LENGth.....	328
:MMEMory:CDIRectory.....	328
:MMEMory:COPI.....	329
:MMEMory:DATA.....	329
:MMEMory:DCATalog.....	330
:MMEMory:DCATalog:LENGth.....	330
:MMEMory:DELeTe.....	330
:MMEMory:LOAD:STATe.....	331
:MMEMory:MDIRectory.....	331
:MMEMory:MOVE.....	331
:MMEMory:MSIS.....	332
:MMEMory:RDIRectory.....	332
:MMEMory:STORE:STATe.....	332
:OUTPut:ALL[:STATe].....	333
:OUTPut:BLANK:MODE.....	334
:OUTPut:BLANK:POLarity.....	335
:OUTPut:BLANK:WIDTh.....	335
:OUTPut:FPRoportional:SCALE.....	335

:OUTPut<hw>:AFIXed:RANGe:LOWer.....	333
:OUTPut<hw>:AFIXed:RANGe:UPPer.....	333
:OUTPut<hw>:ALC:SEARch:MODE.....	334
:OUTPut<hw>:AMODE.....	334
:OUTPut<hw>[:STATe].....	335
:OUTPut<hw>[:STATe]:PON.....	336
:READ<ch>[:POWer].....	342
:SENSe<ch>[:POWer]:SWEep:FREQuency[:SENSor]:OFFSet.....	352
:SENSe<ch>[:POWer]:SWEep:FREQuency[:SENSor]:OFFSet:STATe.....	352
:SENSe<ch>[:POWer]:SWEep:FREQuency[:SENSor]:SRANGe:START.....	353
:SENSe<ch>[:POWer]:SWEep:FREQuency[:SENSor]:SRANGe:STOP.....	353
:SENSe<ch>[:POWer]:SWEep:FREQuency[:SENSor]:SRANGe[:STATe].....	353
:SENSe<ch>[:POWer]:SWEep:POWer[:SENSor]:OFFSet.....	367
:SENSe<ch>[:POWer]:SWEep:POWer[:SENSor]:OFFSet:STATe.....	368
:SENSe<ch>[:POWer]:SWEep:TIME[:SENSor]:OFFSet.....	368
:SENSe<ch>[:POWer]:SWEep:TIME[:SENSor]:OFFSet:STATe.....	369
:SENSe<ch>[:POWer]:SWEep:TIME[:SENSor]:PULSe:STATe.....	369
:SENSe<ch>[:POWer]:SWEep:TIME[:SENSor]:PULSe:THReshold:POWer:HREFerence.....	370
:SENSe<ch>[:POWer]:SWEep:TIME[:SENSor]:PULSe:THReshold:POWer:LREFerence.....	371
:SENSe<ch>[:POWer]:SWEep:TIME[:SENSor]:PULSe:THReshold:POWer:REFerence.....	370
:SENSe<ch>[:POWer]:SWEep:TIME[:SENSor]:TRIGger:SLOPe.....	378
:SENSe[:POWer]:SWEep:FREQuency:REFerence:DATA:COPIY.....	351
:SENSe[:POWer]:SWEep:FREQuency:REFerence:DATA:POINts.....	351
:SENSe[:POWer]:SWEep:FREQuency:REFerence:DATA:XVALues.....	351
:SENSe[:POWer]:SWEep:FREQuency:REFerence:DATA:YVALues.....	351
:SENSe[:POWer]:SWEep:FREQuency:RMODE.....	352
:SENSe[:POWer]:SWEep:FREQuency:SPACing[:MODE].....	354
:SENSe[:POWer]:SWEep:FREQuency:START.....	354
:SENSe[:POWer]:SWEep:FREQuency:STEPs.....	354
:SENSe[:POWer]:SWEep:FREQuency:STOP.....	355
:SENSe[:POWer]:SWEep:FREQuency:TIMing[:MODE].....	355
:SENSe[:POWer]:SWEep:FREQuency:YScale:AUTO.....	355
:SENSe[:POWer]:SWEep:FREQuency:YScale:AUTO:RESet.....	356
:SENSe[:POWer]:SWEep:FREQuency:YScale:MAXimum.....	356
:SENSe[:POWer]:SWEep:FREQuency:YScale:MINimum.....	357
:SENSe[:POWer]:SWEep:INITiate.....	366
:SENSe[:POWer]:SWEep:POWer:REFerence:DATA:COPIY.....	366
:SENSe[:POWer]:SWEep:POWer:REFerence:DATA:POINts.....	366
:SENSe[:POWer]:SWEep:POWer:REFerence:DATA:XVALues.....	367
:SENSe[:POWer]:SWEep:POWer:REFerence:DATA:YVALues.....	367
:SENSe[:POWer]:SWEep:TIME:AVERAge[:COUNT].....	375
:SENSe[:POWer]:SWEep:TIME:REFerence:DATA:COPIY.....	375
:SENSe[:POWer]:SWEep:TIME:REFerence:DATA:POINts.....	375
:SENSe[:POWer]:SWEep:TIME:REFerence:DATA:XVALues.....	375
:SENSe[:POWer]:SWEep:TIME:REFerence:DATA:YVALues.....	376
:SENSe[:POWer]:SWEep:TIME:TEVents.....	379
:SOURce<hw>:PRESet.....	310
:SYSTem:BEEPer:STATe.....	504

:SYSTem:COMMunicate:GPIB:LTERminator.....	505
:SYSTem:COMMunicate:GPIB:RESource.....	508
:SYSTem:COMMunicate:GPIB[:SELF]:ADDRess.....	505
:SYSTem:COMMunicate:NETWork:IPADDRess.....	507
:SYSTem:COMMunicate:NETWork:IPADDRess:MODE.....	506
:SYSTem:COMMunicate:NETWork:RESource.....	507
:SYSTem:COMMunicate:NETWork[:COMMon]:DOMain.....	505
:SYSTem:COMMunicate:NETWork[:COMMon]:HOSTname.....	506
:SYSTem:COMMunicate:NETWork[:COMMon]:WORKgroup.....	506
:SYSTem:COMMunicate:NETWork[:IPADDRess]:GATeway.....	507
:SYSTem:COMMunicate:NETWork[:IPADDRess]:SUBNet:MASK.....	507
:SYSTem:COMMunicate:SERial:BAUD.....	508
:SYSTem:COMMunicate:SERial:PARity.....	509
:SYSTem:COMMunicate:SERial:RESource.....	508
:SYSTem:COMMunicate:SERial:SBITs.....	509
:SYSTem:COMMunicate:SOCKet:RESource.....	509
:SYSTem:COMMunicate:USB:RESource.....	508
:SYSTem:DATE.....	509
:SYSTem:DISPlay:UPDate.....	510
:SYSTem:DLOCK.....	510
:SYSTem:FPReset.....	310
:SYSTem:IDENtification.....	512
:SYSTem:IRESpone.....	513
:SYSTem:KLOCK.....	513
:SYSTem:LANGUage.....	513
:SYSTem:ORESpone.....	514
:SYSTem:PROTect<ch>[:STATe].....	514
:SYSTem:STARtup:COMPLete.....	515
:SYSTem:TIME.....	515
:TEST<hw>:DIRect.....	516
:TRACE<ch>[:POWer]:SWEep:MEASurement:POWer:AVERage:DISPlay:ANNotation[:STATe].....	388
:TRACE<ch>[:POWer]:SWEep:MEASurement:POWer:HREFerence:DISPlay:ANNotation[:STATe].....	388
:TRACE<ch>[:POWer]:SWEep:MEASurement:POWer:LREFerence:DISPlay:ANNotation[:STATe].....	388
:TRACE<ch>[:POWer]:SWEep:MEASurement:POWer:MAXimum:DISPlay:ANNotation[:STATe].....	388
:TRACE<ch>[:POWer]:SWEep:MEASurement:POWer:MINimum:DISPlay:ANNotation[:STATe].....	389
:TRACE<ch>[:POWer]:SWEep:MEASurement:POWer:PULSe:BASE:DISPlay:ANNotation[:STATe].....	388
:TRACE<ch>[:POWer]:SWEep:MEASurement:POWer:PULSe:TOP:DISPlay:ANNotation[:STATe].....	389
:TRACE<ch>[:POWer]:SWEep:MEASurement:POWer:REFerence:DISPlay:ANNotation[:STATe].....	389
:TRACE<ch>[:POWer]:SWEep:MEASurement:PULSe:DCYClE:DISPlay:ANNotation[:STATe].....	388
:TRACE<ch>[:POWer]:SWEep:MEASurement:PULSe:DURation:DISPlay:ANNotation[:STATe].....	388
:TRACE<ch>[:POWer]:SWEep:MEASurement:PULSe:PERiod:DISPlay:ANNotation[:STATe].....	388
:TRACE<ch>[:POWer]:SWEep:MEASurement:PULSe:SEPAration:DISPlay:ANNotation[:STATe].....	389
:TRACE<ch>[:POWer]:SWEep:MEASurement:TRANSition:NEGative:DURation:DISPlay: ANNotation[:STATe].....	389
:TRACE<ch>[:POWer]:SWEep:MEASurement:TRANSition:NEGative:OCCurrence:DISPlay: ANNotation[:STATe].....	389
:TRACE<ch>[:POWer]:SWEep:MEASurement:TRANSition:NEGative:OVERshoot:DISPlay: ANNotation[:STATe].....	389

:TRACE<ch>[:POWer]:SWEep:MEASurement:TRANSition:POSitive:DURation:DISPlay: ANNotation[:STATe].....	389
:TRACE<ch>[:POWer]:SWEep:MEASurement:TRANSition:POSitive:OCCurrence:DISPlay: ANNotation[:STATe].....	389
:TRACE<ch>[:POWer]:SWEep:MEASurement:TRANSition:POSitive:OVERshoot:DISPlay: ANNotation[:STATe].....	389
:TRACe<ch>[:POWer]:SWEep:COLor.....	383
:TRACe<ch>[:POWer]:SWEep:COpy.....	384
:TRACe<ch>[:POWer]:SWEep:DATA:POINts.....	384
:TRACe<ch>[:POWer]:SWEep:DATA:XVALues.....	384
:TRACe<ch>[:POWer]:SWEep:DATA:YVALues.....	385
:TRACe<ch>[:POWer]:SWEep:FEED.....	385
:TRACe<ch>[:POWer]:SWEep:MEASurement:POWer:AVERage.....	386
:TRACe<ch>[:POWer]:SWEep:MEASurement:POWer:HREFerence.....	386
:TRACe<ch>[:POWer]:SWEep:MEASurement:POWer:LREFerence.....	386
:TRACe<ch>[:POWer]:SWEep:MEASurement:POWer:MAXimum.....	386
:TRACe<ch>[:POWer]:SWEep:MEASurement:POWer:MINimum.....	386
:TRACe<ch>[:POWer]:SWEep:MEASurement:POWer:PULSe:BASE.....	386
:TRACe<ch>[:POWer]:SWEep:MEASurement:POWer:PULSe:TOP.....	386
:TRACe<ch>[:POWer]:SWEep:MEASurement:POWer:REFerence.....	387
:TRACe<ch>[:POWer]:SWEep:MEASurement:PULSe:ALL:DISPlay:ANNotation[:STATe].....	388
:TRACe<ch>[:POWer]:SWEep:MEASurement:PULSe:DCYCLE.....	387
:TRACe<ch>[:POWer]:SWEep:MEASurement:PULSe:DURation.....	387
:TRACe<ch>[:POWer]:SWEep:MEASurement:PULSe:PERiod.....	387
:TRACe<ch>[:POWer]:SWEep:MEASurement:PULSe:SEPARation.....	387
:TRACe<ch>[:POWer]:SWEep:MEASurement:PULSe:STATe.....	387
:TRACe<ch>[:POWer]:SWEep:MEASurement:TRANSition:NEGative:DURation.....	387
:TRACe<ch>[:POWer]:SWEep:MEASurement:TRANSition:NEGative:OCCurrence.....	387
:TRACe<ch>[:POWer]:SWEep:MEASurement:TRANSition:NEGative:OVERshoot.....	387
:TRACe<ch>[:POWer]:SWEep:MEASurement:TRANSition:POSitive:DURation.....	387
:TRACe<ch>[:POWer]:SWEep:MEASurement:TRANSition:POSitive:OCCurrence.....	387
:TRACe<ch>[:POWer]:SWEep:MEASurement:TRANSition:POSitive:OVERshoot.....	387
:TRACe<ch>[:POWer]:SWEep:PULSe:THReshold:BASE.....	389
:TRACe<ch>[:POWer]:SWEep:PULSe:THReshold:POWer:HREFerence.....	390
:TRACe<ch>[:POWer]:SWEep:PULSe:THReshold:POWer:LREFerence.....	390
:TRACe<ch>[:POWer]:SWEep:PULSe:THReshold:POWer:REFerence.....	390
:TRACe<ch>[:POWer]:SWEep:STATe.....	391
:TRACe[:POWer]:SWEep:MEASurement:FULLscreen:DISPlay:ANNotation[:STATe].....	386
:TRACe[:POWer]:SWEep:MEASurement:GATE:DISPlay:ANNotation[:STATe].....	386
:TRACe[:POWer]:SWEep:MEASurement:MARKer:DISPlay:ANNotation[:STATe].....	386
:TRACe[:POWer]:SWEep:MEASurement:PULSe:DISPlay:ANNotation[:STATe].....	387
:TRACe[:POWer]:SWEep:MEASurement:STANdard:DISPlay:ANNotation[:STATe].....	388
:TRIGger<hw>:FSWeep:SOURce.....	518
:TRIGger<hw>:FSWeep[:IMMEDIATE].....	518
:TRIGger<hw>:LFFSweep:SOURce.....	517
:TRIGger<hw>:LFVSweep:SOURce.....	519
:TRIGger<hw>:PSWeep:SOURce.....	520
:TRIGger<hw>:PSWeep[:IMMEDIATE].....	520

:TRIGger<hw>[:SWEep]:SOURce.....	521
:TRIGger<hw>[:SWEep][:IMMediate].....	521
:UNIT:ANGLE.....	522
:UNIT:POWer.....	523
SENSe<ch>:UNIT[:POWer].....	382
SENSe<ch>[:POWer]:CORRection:SPDeVice:STATe.....	345
SENSe<ch>[:POWer]:DISPlay:PERManent:PRiority.....	345
SENSe<ch>[:POWer]:DISPlay:PERManent:STATe.....	346
SENSe<ch>[:POWer]:FILTer:LENGth:AUTO.....	346
SENSe<ch>[:POWer]:FILTer:LENGth[:USER].....	346
SENSe<ch>[:POWer]:FILTer:NSRatio.....	347
SENSe<ch>[:POWer]:FILTer:NSRatio:MTIME.....	347
SENSe<ch>[:POWer]:FILTer:SONCe.....	347
SENSe<ch>[:POWer]:FILTer:TYPE.....	348
SENSe<ch>[:POWer]:FREQUency.....	348
SENSe<ch>[:POWer]:OFFSet.....	349
SENSe<ch>[:POWer]:OFFSet:STATe.....	349
SENSe<ch>[:POWer]:SNUMber.....	349
SENSe<ch>[:POWer]:SOURce.....	349
SENSe<ch>[:POWer]:STATus[:DEVice].....	350
SENSe<ch>[:POWer]:SVERsion.....	350
SENSe<ch>[:POWer]:SWEep:POWer[:SENSor]:SFRequency.....	368
SENSe<ch>[:POWer]:SWEep:POWer[:SENSor]:SFRequency:STATe.....	368
SENSe<ch>[:POWer]:SWEep:TIME[:SENSor]:PULSe:THReshold:BASE.....	369
SENSe<ch>[:POWer]:SWEep:TIME[:SENSor]:SFRequency.....	376
SENSe<ch>[:POWer]:SWEep:TIME[:SENSor]:SFRequency:STATe.....	376
SENSe<ch>[:POWer]:SWEep:TIME[:SENSor]:TRIGger:AUTO.....	376
SENSe<ch>[:POWer]:SWEep:TIME[:SENSor]:TRIGger:DTIME.....	377
SENSe<ch>[:POWer]:SWEep:TIME[:SENSor]:TRIGger:HYSTeresis.....	377
SENSe<ch>[:POWer]:SWEep:TIME[:SENSor]:TRIGger:LEVel.....	377
SENSe<ch>[:POWer]:SWEep:TIME[:SENSor]:TRIGger:SOURce.....	378
SENSe<ch>[:POWer]:TYPE.....	381
SENSe<ch>[:POWer]:ZERO.....	381
SENSe[:POWer]:SWEep:ABORT.....	350
SENSe[:POWer]:SWEep:HCOPY:DATA.....	357
SENSe[:POWer]:SWEep:HCOPY:DEVICE.....	358
SENSe[:POWer]:SWEep:HCOPY:DEVICE:LANGUage.....	359
SENSe[:POWer]:SWEep:HCOPY:DEVICE:LANGUage:CSV:DPOint.....	359
SENSe[:POWer]:SWEep:HCOPY:DEVICE:LANGUage:CSV:HEADer.....	359
SENSe[:POWer]:SWEep:HCOPY:DEVICE:LANGUage:CSV:ORientation.....	360
SENSe[:POWer]:SWEep:HCOPY:DEVICE:LANGUage:CSV[:COLumn]:SEPArator.....	360
SENSe[:POWer]:SWEep:HCOPY:DEVICE:SIZE.....	360
SENSe[:POWer]:SWEep:HCOPY:FILE[:NAME].....	361
SENSe[:POWer]:SWEep:HCOPY:FILE[:NAME]:AUTO:DIRectory.....	362
SENSe[:POWer]:SWEep:HCOPY:FILE[:NAME]:AUTO:DIRectory:CLEAr.....	362
SENSe[:POWer]:SWEep:HCOPY:FILE[:NAME]:AUTO:FILE.....	362
SENSe[:POWer]:SWEep:HCOPY:FILE[:NAME]:AUTO:STATe.....	365
SENSe[:POWer]:SWEep:HCOPY:FILE[:NAME]:AUTO[:FILE]:DAY.....	363

SENSe[:POWer]:SWEep:HCOPy:FILE[:NAME]:AUTO[:FILE]:DAY:STATe.....	363
SENSe[:POWer]:SWEep:HCOPy:FILE[:NAME]:AUTO[:FILE]:MONTh.....	363
SENSe[:POWer]:SWEep:HCOPy:FILE[:NAME]:AUTO[:FILE]:MONTh:STATe.....	364
SENSe[:POWer]:SWEep:HCOPy:FILE[:NAME]:AUTO[:FILE]:NUMBer.....	364
SENSe[:POWer]:SWEep:HCOPy:FILE[:NAME]:AUTO[:FILE]:PREFix.....	364
SENSe[:POWer]:SWEep:HCOPy:FILE[:NAME]:AUTO[:FILE]:PREFix:STATe.....	364
SENSe[:POWer]:SWEep:HCOPy:FILE[:NAME]:AUTO[:FILE]:YEAR.....	365
SENSe[:POWer]:SWEep:HCOPy:FILE[:NAME]:AUTO[:FILE]:YEAR:STATe.....	365
SENSe[:POWer]:SWEep:HCOPy[:EXECute].....	361
SENSe[:POWer]:SWEep:MODE.....	366
SENSe[:POWer]:SWEep:POWer:RMODE.....	367
SENSe[:POWer]:SWEep:POWer:SPACing[:MODE].....	371
SENSe[:POWer]:SWEep:POWer:START.....	371
SENSe[:POWer]:SWEep:POWer:STEPs.....	371
SENSe[:POWer]:SWEep:POWer:STOP.....	372
SENSe[:POWer]:SWEep:POWer:TIMing[:MODE].....	372
SENSe[:POWer]:SWEep:POWer:YSCale:AUTO.....	372
SENSe[:POWer]:SWEep:POWer:YSCale:AUTO:RESet.....	373
SENSe[:POWer]:SWEep:POWer:YSCale:MAXimum.....	373
SENSe[:POWer]:SWEep:POWer:YSCale:MINimum.....	374
SENSe[:POWer]:SWEep:RMODE.....	374
SENSe[:POWer]:SWEep:TIME:RMODE.....	374
SENSe[:POWer]:SWEep:TIME:SPACing[:MODE].....	378
SENSe[:POWer]:SWEep:TIME:START.....	378
SENSe[:POWer]:SWEep:TIME:STEPs.....	379
SENSe[:POWer]:SWEep:TIME:STOP.....	379
SENSe[:POWer]:SWEep:TIME:YSCale:AUTO.....	380
SENSe[:POWer]:SWEep:TIME:YSCale:AUTO:RESet.....	380
SENSe[:POWer]:SWEep:TIME:YSCale:MAXimum.....	381
SENSe[:POWer]:SWEep:TIME:YSCale:MINimum.....	381
STATus:OPERation:CONDition.....	500
STATus:OPERation:ENABLE.....	500
STATus:OPERation:NTRansition.....	501
STATus:OPERation:PTRansition.....	501
STATus:OPERation[:EVENT].....	500
STATus:PRESet.....	501
STATus:QUEStionable:CONDition.....	502
STATus:QUEStionable:ENABLE.....	502
STATus:QUEStionable:NTRansition.....	503
STATus:QUEStionable:PTRansition.....	503
STATus:QUEStionable[:EVENT].....	502
STATus:QUEue[:NEXT].....	503
SYSTem:ERRor:ALL.....	510
SYSTem:ERRor:CODE:ALL.....	511
SYSTem:ERRor:CODE[:NEXT].....	511
SYSTem:ERRor:COUNT.....	511
SYSTem:ERRor[:NEXT].....	512
SYSTem:PRESet.....	310

SYSTem:SERRor.....	514
SYSTem:VERSion.....	515
[:SOURce<hw>]:AM:RATio.....	392
[:SOURce<hw>]:AM:SCAN:STATe.....	393
[:SOURce<hw>]:AM<ch>:SENSitivity.....	393
[:SOURce<hw>]:AM<ch>:SOURce.....	393
[:SOURce<hw>]:AM<ch>:STATe.....	394
[:SOURce<hw>]:AM<ch>[:DEPTH].....	392
[:SOURce<hw>]:CHIRp:BANDwidth.....	394
[:SOURce<hw>]:CHIRp:COMPReSSion:RATio.....	395
[:SOURce<hw>]:CHIRp:DIReCTion.....	395
[:SOURce<hw>]:CHIRp:PULSe:PERiod.....	395
[:SOURce<hw>]:CHIRp:PULSe:WIDTh.....	395
[:SOURce<hw>]:CHIRp:STATe.....	396
[:SOURce<hw>]:CHIRp:TRIGger:EXTernal:GATE:POLarity.....	396
[:SOURce<hw>]:CHIRp:TRIGger:EXTernal:IMPedance.....	396
[:SOURce<hw>]:CHIRp:TRIGger:EXTernal:LEVel.....	397
[:SOURce<hw>]:CHIRp:TRIGger:EXTernal:SLOPe.....	397
[:SOURce<hw>]:CHIRp:TRIGger:MODE.....	397
[:SOURce<hw>]:CORRection:CSET:DATA:FREQuency.....	399
[:SOURce<hw>]:CORRection:CSET:DATA:FREQuency:POINts.....	400
[:SOURce<hw>]:CORRection:CSET:DATA:POWer.....	400
[:SOURce<hw>]:CORRection:CSET:DATA:POWer:POINts.....	400
[:SOURce<hw>]:CORRection:CSET:DATA[:SENSor<ch>][:POWer]:SONCe.....	401
[:SOURce<hw>]:CORRection:CSET[:SELeCt].....	405
[:SOURce<hw>]:CORRection:DEXChange:AFILe:CATalog.....	401
[:SOURce<hw>]:CORRection:DEXChange:AFILe:EXTension.....	402
[:SOURce<hw>]:CORRection:DEXChange:AFILe:SELeCt.....	402
[:SOURce<hw>]:CORRection:DEXChange:AFILe:SEParator:COLumn.....	403
[:SOURce<hw>]:CORRection:DEXChange:AFILe:SEParator:DECimal.....	403
[:SOURce<hw>]:CORRection:DEXChange:EXECute.....	404
[:SOURce<hw>]:CORRection:DEXChange:MODE.....	404
[:SOURce<hw>]:CORRection:DEXChange:SELeCt.....	405
[:SOURce<hw>]:CORRection:MEASure.....	406
[:SOURce<hw>]:CORRection:PMETer:TYPE.....	406
[:SOURce<hw>]:CORRection:VALue.....	406
[:SOURce<hw>]:CORRection[:STATe].....	406
[:SOURce<hw>]:DM:ASK:DEPTH.....	407
[:SOURce<hw>]:DM:ASK:SOURce.....	407
[:SOURce<hw>]:DM:ASK:STATe.....	408
[:SOURce<hw>]:DM:EXTernal:POLarity<ch>.....	408
[:SOURce<hw>]:DM:FSK:DEVIation.....	408
[:SOURce<hw>]:DM:FSK:SOURce.....	408
[:SOURce<hw>]:DM:FSK:STATe.....	409
[:SOURce<hw>]:DM:PSK:DEVIation.....	409
[:SOURce<hw>]:DM:PSK:SOURce.....	409
[:SOURce<hw>]:DM:PSK:STATe.....	410
[:SOURce<hw>]:FM:MODE.....	411

[:SOURce<hw>]:FM:RATio.....	411
[:SOURce<hw>]:FM<ch>:SOURce.....	412
[:SOURce<hw>]:FM<ch>:STATe.....	412
[:SOURce<hw>]:FM<ch>[:DEViation].....	411
[:SOURce<hw>]:FREQuency:CENTer.....	413
[:SOURce<hw>]:FREQuency:MANual.....	414
[:SOURce<hw>]:FREQuency:MODE.....	415
[:SOURce<hw>]:FREQuency:MULTiplier.....	416
[:SOURce<hw>]:FREQuency:OFFSet.....	416
[:SOURce<hw>]:FREQuency:SPAN.....	416
[:SOURce<hw>]:FREQuency:START.....	417
[:SOURce<hw>]:FREQuency:STEP:MODE.....	418
[:SOURce<hw>]:FREQuency:STEP[:INCRement].....	418
[:SOURce<hw>]:FREQuency:STOP.....	417
[:SOURce<hw>]:FREQuency[:CW]:FIXed].....	413
[:SOURce<hw>]:FREQuency[:CW]:FIXed]:RCL.....	414
[:SOURce<hw>]:INPut:MODext:COUPling<ch>.....	419
[:SOURce<hw>]:INPut:MODext:IMPedance<ch>.....	419
[:SOURce<hw>]:LFOutput:SWEep:VOLTAGE:MARKer<ch>:VSTate.....	434
[:SOURce<hw>]:LFOutput:SWEep:VOLTage:MARKer<ch>:VOLTage.....	433
[:SOURce<hw>]:LIST:CATalog.....	443
[:SOURce<hw>]:LIST:DELete.....	443
[:SOURce<hw>]:LIST:DELete:ALL.....	444
[:SOURce<hw>]:LIST:DEXChange:AFILe:CATalog.....	444
[:SOURce<hw>]:LIST:DEXChange:AFILe:EXTension.....	445
[:SOURce<hw>]:LIST:DEXChange:AFILe:SElect.....	445
[:SOURce<hw>]:LIST:DEXChange:AFILe:SEParator:COLumn.....	446
[:SOURce<hw>]:LIST:DEXChange:AFILe:SEParator:DECimal.....	446
[:SOURce<hw>]:LIST:DEXChange:EXECute.....	447
[:SOURce<hw>]:LIST:DEXChange:MODE.....	447
[:SOURce<hw>]:LIST:DEXChange:SElect.....	448
[:SOURce<hw>]:LIST:DWELL.....	448
[:SOURce<hw>]:LIST:FREE.....	449
[:SOURce<hw>]:LIST:FREQuency.....	449
[:SOURce<hw>]:LIST:FREQuency:POINts.....	449
[:SOURce<hw>]:LIST:INDEx.....	450
[:SOURce<hw>]:LIST:INDEx:START.....	450
[:SOURce<hw>]:LIST:INDEx:STOP.....	451
[:SOURce<hw>]:LIST:LEARn.....	451
[:SOURce<hw>]:LIST:MODE.....	451
[:SOURce<hw>]:LIST:POWer.....	452
[:SOURce<hw>]:LIST:POWer:AMODE.....	452
[:SOURce<hw>]:LIST:POWer:POINts.....	453
[:SOURce<hw>]:LIST:RESet.....	453
[:SOURce<hw>]:LIST:SElect.....	453
[:SOURce<hw>]:LIST:TRIGger:EXECute.....	454
[:SOURce<hw>]:LIST:TRIGger:SOURce.....	454
[:SOURce<hw>]:MODulation[:ALL]:STATe.....	455

[:SOURce<hw>]:NOISe:BWIDth.....	455
[:SOURce<hw>]:NOISe:DISTRibution.....	455
[:SOURce<hw>]:NOISe:LEVel:RELative.....	456
[:SOURce<hw>]:NOISe:LEVel[:ABSolute].....	456
[:SOURce<hw>]:PGEN:OUTPut:POLarity.....	456
[:SOURce<hw>]:PGEN:OUTPut[:STATe].....	457
[:SOURce<hw>]:PHASe.....	457
[:SOURce<hw>]:PHASe:REFerence.....	458
[:SOURce<hw>]:PM:MODE.....	458
[:SOURce<hw>]:PM:RATio.....	459
[:SOURce<hw>]:PM<ch>:SOURce.....	459
[:SOURce<hw>]:PM<ch>:STATe.....	460
[:SOURce<hw>]:POWer:ALC:PMETer:TYPE.....	460
[:SOURce<hw>]:POWer:ALC:REFerence.....	461
[:SOURce<hw>]:POWer:ALC:SONCe.....	461
[:SOURce<hw>]:POWer:ALC:SOURce.....	461
[:SOURce<hw>]:POWer:ALC[:STATe].....	462
[:SOURce<hw>]:POWer:ATTenuation:RFOff:MODE.....	462
[:SOURce<hw>]:POWer:LIMit[:AMPLitude].....	464
[:SOURce<hw>]:POWer:MANual.....	465
[:SOURce<hw>]:POWer:MODE.....	466
[:SOURce<hw>]:POWer:POWer.....	466
[:SOURce<hw>]:POWer:RESolution.....	467
[:SOURce<hw>]:POWer:START.....	467
[:SOURce<hw>]:POWer:STEP:MODE.....	468
[:SOURce<hw>]:POWer:STEP[:INCRement].....	468
[:SOURce<hw>]:POWer:STOP.....	468
[:SOURce<hw>]:POWer[:LEVel][:IMMediate]:OFFSet.....	463
[:SOURce<hw>]:POWer[:LEVel][:IMMediate]:RCL.....	464
[:SOURce<hw>]:POWer[:LEVel][:IMMediate][:AMPLitude].....	463
[:SOURce<hw>]:PULM:DELay.....	470
[:SOURce<hw>]:PULM:DOUBle:DELay.....	470
[:SOURce<hw>]:PULM:DOUBle:STATe.....	470
[:SOURce<hw>]:PULM:DOUBle:WIDTh.....	471
[:SOURce<hw>]:PULM:MODE.....	471
[:SOURce<hw>]:PULM:OUTPut:VIDeo:POLarity.....	471
[:SOURce<hw>]:PULM:PERiod.....	472
[:SOURce<hw>]:PULM:POLarity.....	472
[:SOURce<hw>]:PULM:SOURce.....	473
[:SOURce<hw>]:PULM:STATe.....	473
[:SOURce<hw>]:PULM:TRAI:n:CATalog.....	474
[:SOURce<hw>]:PULM:TRAI:n:DELete.....	474
[:SOURce<hw>]:PULM:TRAI:n:DEXChange:AFILe:CATalog.....	479
[:SOURce<hw>]:PULM:TRAI:n:DEXChange:AFILe:EXTension.....	480
[:SOURce<hw>]:PULM:TRAI:n:DEXChange:AFILe:SELect.....	480
[:SOURce<hw>]:PULM:TRAI:n:DEXChange:AFILe:SEPARator:COLumn.....	481
[:SOURce<hw>]:PULM:TRAI:n:DEXChange:AFILe:SEPARator:DECimal.....	481
[:SOURce<hw>]:PULM:TRAI:n:DEXChange:EXECute.....	482

[:SOURce<hw>]:PULM:TRAIIn:DEXChange:MODE.....	482
[:SOURce<hw>]:PULM:TRAIIn:DEXChange:SELEct.....	483
[:SOURce<hw>]:PULM:TRAIIn:OFFTime.....	474
[:SOURce<hw>]:PULM:TRAIIn:OFFTime:POINts.....	475
[:SOURce<hw>]:PULM:TRAIIn:ONTime.....	475
[:SOURce<hw>]:PULM:TRAIIn:ONTime:POINts.....	476
[:SOURce<hw>]:PULM:TRAIIn:REPetition.....	476
[:SOURce<hw>]:PULM:TRAIIn:REPetition:POINts.....	477
[:SOURce<hw>]:PULM:TRAIIn:SELEct.....	477
[:SOURce<hw>]:PULM:TRIGger:EXTErnal:GATE:POLarity.....	478
[:SOURce<hw>]:PULM:TRIGger:EXTErnal:IMPedance.....	478
[:SOURce<hw>]:PULM:TRIGger:EXTErnal:LEVel.....	478
[:SOURce<hw>]:PULM:TRIGger:EXTErnal:SLOPe.....	479
[:SOURce<hw>]:PULM:TRIGger:MODE.....	479
[:SOURce<hw>]:PULM:WIDTh.....	483
[:SOURce<hw>]:SWEep:MARKer:OUTPut:POLarity.....	495
[:SOURce<hw>]:SWEep:POWer:AMODE.....	495
[:SOURce<hw>]:SWEep:POWer:DWELI.....	495
[:SOURce<hw>]:SWEep:POWer:EXECute.....	496
[:SOURce<hw>]:SWEep:POWer:MARKer:ACTive.....	496
[:SOURce<hw>]:SWEep:POWer:MARKer:AOFF.....	496
[:SOURce<hw>]:SWEep:POWer:MARKer<ch>:POWer.....	497
[:SOURce<hw>]:SWEep:POWer:MARKer<ch>:STATE.....	497
[:SOURce<hw>]:SWEep:POWer:MODE.....	497
[:SOURce<hw>]:SWEep:POWer:POINts.....	498
[:SOURce<hw>]:SWEep:POWer:SHAPE.....	498
[:SOURce<hw>]:SWEep:POWer:SPACing:MODE.....	498
[:SOURce<hw>]:SWEep:POWer:STEP[:LOGarithmic].....	499
[:SOURce<hw>]:SWEep:RESEt[:ALL].....	499
[:SOURce<hw>]:SWEep[:FREQUency]:DWELI.....	488
[:SOURce<hw>]:SWEep[:FREQUency]:EXECute.....	488
[:SOURce<hw>]:SWEep[:FREQUency]:MARKer:ACTive.....	489
[:SOURce<hw>]:SWEep[:FREQUency]:MARKer:AMPLitude.....	489
[:SOURce<hw>]:SWEep[:FREQUency]:MARKer:AOFF.....	489
[:SOURce<hw>]:SWEep[:FREQUency]:MARKer:XFER.....	490
[:SOURce<hw>]:SWEep[:FREQUency]:MARKer<ch>:FREQUency.....	490
[:SOURce<hw>]:SWEep[:FREQUency]:MARKer<ch>:FState.....	490
[:SOURce<hw>]:SWEep[:FREQUency]:MARKer<ch>:PState.....	490
[:SOURce<hw>]:SWEep[:FREQUency]:MODE.....	491
[:SOURce<hw>]:SWEep[:FREQUency]:POINts.....	491
[:SOURce<hw>]:SWEep[:FREQUency]:SHAPE.....	492
[:SOURce<hw>]:SWEep[:FREQUency]:SPACing.....	492
[:SOURce<hw>]:SWEep[:FREQUency]:STEP:LOGarithmic.....	494
[:SOURce<hw>]:SWEep[:FREQUency]:STEP[:LINear].....	493
[:SOURce<hw>]:SWEep[:FREQUency]:TIME.....	494
[:SOURce]:CORRection:CSET:CATalog.....	399
[:SOURce]:CORRection:CSET:DELEte.....	401
[:SOURce]:INPut:TRIGger:SLOPe.....	420

[:SOURce]:LFOutput:FREQuency:MANual.....	422
[:SOURce]:LFOutput:FREQuency:MODE.....	423
[:SOURce]:LFOutput:FREQuency:STARt.....	423
[:SOURce]:LFOutput:FREQuency:STOP.....	424
[:SOURce]:LFOutput:MONitor:MODE.....	424
[:SOURce]:LFOutput:OFFSet.....	425
[:SOURce]:LFOutput:SWEep:VOLTagE:DWELI.....	432
[:SOURce]:LFOutput:SWEep:VOLTagE:EXECute.....	432
[:SOURce]:LFOutput:SWEep:VOLTagE:LFSource.....	433
[:SOURce]:LFOutput:SWEep:VOLTagE:MARKer:ACTive.....	433
[:SOURce]:LFOutput:SWEep:VOLTagE:MARKer:AOFF.....	433
[:SOURce]:LFOutput:SWEep:VOLTagE:MODE.....	434
[:SOURce]:LFOutput:SWEep:VOLTagE:POINts.....	434
[:SOURce]:LFOutput:SWEep:VOLTagE:SHAPE.....	435
[:SOURce]:LFOutput:SWEep:VOLTagE:STEP[:LINear].....	435
[:SOURce]:LFOutput:SWEep[:FREQuency]:DWELI.....	426
[:SOURce]:LFOutput:SWEep[:FREQuency]:EXECute.....	426
[:SOURce]:LFOutput:SWEep[:FREQuency]:LFSource.....	426
[:SOURce]:LFOutput:SWEep[:FREQuency]:MARKer:ACTive.....	427
[:SOURce]:LFOutput:SWEep[:FREQuency]:MARKer:AMPLitude.....	427
[:SOURce]:LFOutput:SWEep[:FREQuency]:MARKer:AOFF.....	427
[:SOURce]:LFOutput:SWEep[:FREQuency]:MARKer<ch>:FREQuency.....	427
[:SOURce]:LFOutput:SWEep[:FREQuency]:MARKer<ch>:FState.....	428
[:SOURce]:LFOutput:SWEep[:FREQuency]:MARKer<ch>:VState.....	428
[:SOURce]:LFOutput:SWEep[:FREQuency]:MODE.....	428
[:SOURce]:LFOutput:SWEep[:FREQuency]:POINts.....	429
[:SOURce]:LFOutput:SWEep[:FREQuency]:SHAPE.....	430
[:SOURce]:LFOutput:SWEep[:FREQuency]:SPACing.....	430
[:SOURce]:LFOutput:SWEep[:FREQuency]:STEP:LOGarithmic.....	431
[:SOURce]:LFOutput:SWEep[:FREQuency]:STEP[:LINear].....	431
[:SOURce]:LFOutput:VOLTagE:MANual.....	439
[:SOURce]:LFOutput:VOLTagE:MODE.....	440
[:SOURce]:LFOutput:VOLTagE:STARt.....	440
[:SOURce]:LFOutput:VOLTagE:STOP.....	441
[:SOURce]:LFOutput<ch>:BANDwidth.....	422
[:SOURce]:LFOutput<ch>:FREQuency.....	422
[:SOURce]:LFOutput<ch>:SHAPE.....	436
[:SOURce]:LFOutput<ch>:SHAPE:PULSe:DCYCLE.....	436
[:SOURce]:LFOutput<ch>:SHAPE:PULSe:PERiod.....	436
[:SOURce]:LFOutput<ch>:SHAPE:PULSe:WIDTh.....	436
[:SOURce]:LFOutput<ch>:SHAPE:TRAPeZe:FALL.....	437
[:SOURce]:LFOutput<ch>:SHAPE:TRAPeZe:HIGH.....	437
[:SOURce]:LFOutput<ch>:SHAPE:TRAPeZe:PERiod.....	437
[:SOURce]:LFOutput<ch>:SHAPE:TRAPeZe:RISE.....	438
[:SOURce]:LFOutput<ch>:SHAPE:TRlangle:PERiod.....	438
[:SOURce]:LFOutput<ch>:SHAPE:TRlangle:RISE.....	438
[:SOURce]:LFOutput<ch>:SOURce.....	425
[:SOURce]:LFOutput<ch>:VOLTagE.....	439

[[:SOURce]:LFOutput<ch>[:STATe].....	425
[[:SOURce]:PM<ch>[:DEViation].....	458
[[:SOURce]:POWer:ATTenuation.....	462
[[:SOURce]:ROSCillator:EFC:STATe.....	484
[[:SOURce]:ROSCillator:EXTernal:FREQuency.....	484
[[:SOURce]:ROSCillator:EXTernal:RFOff:STATe.....	484
[[:SOURce]:ROSCillator:EXTernal:SBANdwidth.....	485
[[:SOURce]:ROSCillator:OUTPut:SOURce.....	486
[[:SOURce]:ROSCillator:SOURce.....	486
[[:SOURce]:ROSCillator[:INTernal]:ADJust:VALue.....	485
[[:SOURce]:ROSCillator[:INTernal]:ADJust[:STATe].....	486

Index

- 50 - Extern reference out of range or disconnected 531
 - 140 - This modulation forces other modulations off 531
 - 180 - Adjustment failed 531
 - 182 - Adjustment data missing 531
 - 183 - Adjustment data invalid 531
 - 200 - Cannot access hardware 531
 - 201 - Hardware revision out of date 532
 - 202 - Cannot access the EEPROM 532
 - 203 - Invalid EEPROM data 532
 - 204 - river initialization failed 532
 - 241 - No current list 532
 - 242 - Unknown list type specified 532
 - 460 - Cannot open file 532
 - 461 - Cannot write file 532
 - 462 - Cannot read file 532
 - 463 - Filename missing 532
 - 464 - Invalid filename extension 532
 - 465 - File contains invalid data 532
 - >L 273
 - &LLO 273
 - &NREN 273
 - *IDN? 512
 - *OPC 294
 - *OPC? 294
 - *RST 303
 - *WAI 294
 - /var directory 324
- A**
- Abort button 75
 - Abort calculation 75
 - Accept
 - Security Settings 110
 - Access denied 68
 - AC supply 24
 - Active Marker 246, 255
 - RF frequency marker 137
 - Active Marker -LF Level Sweep 433
 - Active Marker - RF Level Marker 160, 496
 - Adjust All 91, 311
 - Adjust Level 92, 312
 - Adjust LF Gen/Mod Gen 313
 - Adjustment Active 148, 486
 - Adjustment Data 312
 - Adjustment Frequency 148, 485
 - Adjustment value - Reference frequency 148, 485
 - Adjust modulation LF generator 92
 - Adjust Synthesis 91, 312
 - Adjust Synthesis Extension 91
 - ALC (automatic level control) 160
 - ALC Auto 529
 - ALC On 160, 529
 - ALC S&H 529
 - ALC Table 529
 - All Trigger Events - Power Sensors 379
 - AM Depth 219, 392
 - AM Frequency 422
 - Amplitude
 - LF Frequency Marker 246
 - RF frequency marker 137
 - Amplitude - LF Frequency Marker 427
 - Amplitude Marker 246
 - RF frequency marker 136
 - AM SCAN State 393
 - AM Sensitivity 220, 393
 - AM Source 219, 393
 - AM State 219
 - Analyzer Type 103
 - Annotation Amplitude 109
 - Annotation Frequency 109
 - Architecture of the instrument 45
 - Arrow keys 20
 - ASCII file import/export
 - List Mode 137
 - ASK Source 227, 407
 - ASK State 227, 408
 - Assemblies display 92, 313, 314
 - ATN 533
 - Attention 533
 - Attenuator 263, 334
 - Attenuator Mode 334
 - Sweep 495
 - Attenuator Mode - List Mode 452
 - Attenuator settings
 - RF OFF mode 462
 - Attenuator Settings
 - Attenuation 143, 263, 462
 - Fixed Range (PEP) in 143, 264
 - Mode 143, 263
 - RF OFF Mode 143, 264
 - AttFixed 529
 - Automatic Naming Hardcopy 323
 - Power Analysis 204
 - Automatic Naming Hardcopy - Power Analysis 365
 - Auto Once
 - Power Sensors 168
 - Auto Once - Power Sensors 347
 - Auto Scale
 - Power Analysis 183
 - Auto Scale - Power Analysis 355, 372, 380
 - Auto Set
 - Power Sensors 202
 - Auxiliary I/O Settings 102
 - Average
 - Power Analysis 181
 - Average - Power Analysis 375
- B**
- Background color
 - Power Analysis 184, 341
 - Bandwidth
 - Chirp modulation 234
 - Noise 455
 - Bandwidth – External Inputs 217, 422
 - Bandwidth - Noise 239
 - Baudrate 508
 - Baudrate - RS232 Interface 105
 - Blank polarity 103
 - Blank width 103
 - Bluetooth Pin 110
 - Bluetooth Setup 105
 - Boolean parameters 289

BUSY	528	Connection to an external controller	38
C		Connector	
Calibration		AUX I/O	23
remote	305	BLANK	24
Case-sensitivity		EFC	24
SCPI	286	EXT 1	21, 22
Center Freq	133, 413	EXT 2	21, 22
Change Password - Setup	108, 109	EXT ALC	22, 25
Check Front Panel	98	GPIB	23
Chirp Deviation	234, 394	IEC/IEEE	23
Chirp modulation	231	LAN	23
Bandwidth	234	LF	21, 25
Compression ratio	234	MARKER	24
Direction	233	PULSE IN	25
External impedance	235	PULSE OUT	25
Ext trigger input slope	235	REF IN	24
Gated signal	235	REF OUT	24
Gate input polarity	235	RF	22
Pulse period	234	RF OUT	24
Pulse width	234	SENSOR	21, 23
State	233	STOP	25
Trigger level	235	SYNC	25
Trigger mode	235	TRIGGER	24
Chirp period	234	USB	22
Clear status		USB type A	23
remote	305	USB type B	23
Colon	290	USER 1	25
Column Separator Import/Export		USER 2	25
List Mode data	446	USER 3	25
Pulse Train data	262	V/GHz	25
Column Separator Import/Export - List Mode data	481	VIDEO	23
Column Separator Import/Export - User Correction data	212, 403	X-AXIS	25
Comma	290	Z-AXIS	25
Commands	266	Continue Adjustment on error	92
Colon	290	Control bus	533
Comma	290	Controller, external	38
Command line structure	291	Copy instrument settings	121, 329
common	266	Count	
Double dagger	290	LF Level Sweep	253
GBIP, addressed	271	Counter	92, 314
GBIP, universal	271	Count – LF Frequency Sweep	244, 429
instrument control	266	Count - LF Level Sweep	434
Overlapping	292	Coupling Mode	419
Question mark	290	Coupling mode - Modulation	217
Quotation mark	290	Create New Directory	122
SCPI compliant	266	CSV Decimal Point Hardcopy - Power Analysis	206, 359
Sequential	292	CSV Header Hardcopy - Power Analysis	206, 359
Syntax elements	290	CSV Orientation Hardcopy - Power Analysis	206, 360
White space	290	CSV Separator Hardcopy - Power Analysis	206, 360
Command sequence		Current Freq	
recommendation	303	LF Sweep	253, 422
remote	309	Current Freq (LF Sweep)	243
Common commands		Current Freq (RF Sweep)	133, 414
Syntax	284	Current Index	450
Compression ratio		List Mode	140
Chirp Modulation	234	Current Level	157, 439, 465
Computer name		Current Sensors	97
Changing	37	Cursor keys	20
Computer name - Setup	100	Cut	121
CONDition	297	D	
Config		Data Valid	533
Power Analysis	174	Date - Setup	99
Confirm Password - Setup	108	DAV	533

- Day Hardcopy File Name 320, 321
 - Power Analysis 204
- Day Hardcopy File Name - Power Analysis 363
- DCL 271
- DC Offset
 - LF output 248
- DC Offset - LF Output 425
- Deactivate RF output 147, 484
- Decimal Point Import/Export
 - List Mode data 446
 - Pulse Train data 262
- Decimal Point Import/Export - List Mode data 144, 481
- Decimal Point Import/Export - User Correction data 212, 403
- DEF 288
- Default instrument settings 30, 89, 310
- Default values
 - remote 308
- Define Reference - Power Analysis 177
- Delete Hardcopy Files 320
 - Power Analysis 204
- Delete Hardcopy Files - Power Analysis 362
- Delete instrument settings 122, 330
- Delta Phase 127, 457
- Depth – ASK 228, 407
- Destination - Hardcopy 113
- Destination Import/Export
 - List Mode data 448
 - Pulse Train data 262
 - User Correction data 213
- Destination Import/Export - List Mode data 145
- Destination Import/Export - Pulse Train data 483
- Destination Import/Export - User Correction data 405
- Deviation – FSK 228, 408
- Deviation – PSK 229, 409
- Device ID 96
- Device reset 310
- Device-specific commands 266
- Device-specific error messages 531
- DHCP 36
- Digital modulation signal 221
- Direction
 - Chirp modulation 233
- Directory 120, 328
- Directory Hardcopy 319
 - Power Analysis 204
- Directory Hardcopy - Power Analysis 362
- Display 63, 109
- Display permanent priority - Power Sensors 166
- Distal Reference - Pulse Data Analysis 370, 390
- Distribution
 - Noise 455
- Distribution - Noise 239
- Documentation Overview 13
- Double dagger 290
- Double Pulse 256
- Double Pulse Delay 257, 470
- Double Pulse State 470
- Double Pulse width 257, 471
- DOWN 288
- Drop out Time - Power Sensors 201, 377
- Dwell time
 - List Mode 448
- Dwell Time 134, 140, 157, 244
 - Level Sweep 495
 - LF Sweep 253, 426
 - List Mode 140
 - RF Sweep 488
- Dwell Time - Level Sweep 432
- E**
- Edit
 - Pulse Train 260
- Edit Marker 135, 245
 - RF Level Sweep 158
- Edit Pulse Train Data 260
- Edit User Correction Data 210
- EFC (Electronic Frequency Control) 146
- EFC - reference oscillator 148
- EFC - Reference Oscillator 484
- EMF - Level display 153
- ENABLE 297
- Enable/disable beep 504
- Enable registers
 - remote 307
- Enter License Key 96
- EOI 533
- Equal Distribution
 - Noise 455
- Error messages 65
 - Adjustment data invalid (183) 531
 - Adjustment data missing (182) 531
 - Adjustment failed (180) 531
 - Cannot access hardware (200) 531
 - Cannot access the EEPROM (202) 532
 - Cannot open file (460) 532
 - Cannot read file (462) 532
 - Cannot write file (461) 532
 - Driver initialization failed (204) 532
 - Extern reference out of range or disconnected (50) 531
 - File contains invalid data (465) 532
 - Filename missing (463) 532
 - Hardware revision out of date (201) 532
 - Invalid EEPROM data (203) 532
 - Invalid filename extension (464) 532
 - No current list (241) 532
 - This modulation forces other modulations off (140) 531
 - Unknown list type specified (242) 532
- Error Messages 530
 - device-specific 531
 - SCPI 530
- Error messages - display list 514
- Error queue query 503, 510, 511, 512
- Error queues
 - recommendations 303
- ESR 296
- EVENT 297
- Event status enable register
 - remote 306
- Event status register
 - remote 306
- Exclude Frequency 120, 414
- Exclude Level 120, 464
- Execute Single
 - List Mode 139
- Execute Single - List Mode 454
- Execute Single Sweep
 - Frequency Sweep 132, 488
 - Level Sweep 156, 496

LF Level Sweep	432
LF Sweep	252, 426
Execute Single Sweep - LF Sweep	242
Expiration date of option	94
Export Deactivation Response	96
Extension Import/Export	
List Mode data	445
Pulse Train data	262
Extension Import/Export - List Mode data	144, 480
Extension Import/Export - User Correction data	212, 402
External impedance	
Chirp Modulation	235
External Impedance	419
External Impedance - Pulse Modulation	235
External Input Impedance	259
Pulse Trigger	478
External Level Control	
Power Meter Type	163
Reference Voltage	163, 460, 461
Source	162, 461
External modulation signal	218
FM	221
External modulation signal – Digital Modulation	226
External modulation signal - PhiM	223
External modulation signal - Pulse	473
External Reference Frequency	147, 484
External tuning - Reference frequency	146
EXT REF	528
Ext trigger input slope	
Chirp Modulation	235
EXT TUNE input	146

F

Factory Preset	111, 310
File - Hardcopy dialog	113
File list	120, 328
File menu	118
File Name - Hardcopy	113
File setup - Hardcopy	114
File type selection	121
Fill Table	
List Mode	141
Fill Table From	145
Fill Table - List mode	145
Fill Table Range	146, 213
Filter	
Power Sensors	168
Filter Length	
Power Sensors	168
Filter Length - Power Sensors	346, 347, 348
Fine adjustment - Reference frequency	148, 486
Firmware version	94
Floating licences	94
FM-DC mode	146
FM Deviation	222, 411
FM Mode	222, 411
FM Source	222, 412, 459
FM State	222, 412
FREQ OFFSET	527
Frequency	150
AM	422
LF generator	422
LF Generator	220, 223, 225, 237, 248
List mode	449
List Mode	141

PM	256, 422
Power Sensors	167
Pulse Modulation	472
RF frequency marker	136
RF output signal	413
RF Sweep	417
Frequency display	63
Frequency marker	
LF generator	427, 428
Frequency marker active	
LF generator	427
Frequency marker all off	
LF generator	427
Frequency marker amplitude	
LF generator	427
Frequency marker state	
LF generator	428
Frequency - Modulation chirp	234
Frequency - Multiplier	126
Frequency Offset	126, 416
Multiplier	416
Frequency - RF Frequency Marker	489
Frequency - RF output signal	125
Frequency - RF Signal	126
Frequency - RF Sweep	132
Front panel key emulation	84
FSK Source	228, 408
FSK State	228, 409
Fullscreen view	
Power Analysis	184
Fullscreen view - Power Analysis)	386
Fuses	28

G

Gate	
Average Power	188, 337
Peak Power	188, 338
Trace	338
Gated	
pulse trigger input	259
Gated signal	
Chirp Modulation	235
Gated Signal	
Pulse Modulation	257, 479
Gate input polarity	
Chirp Modulation	235
Gate Input Polarity	259
Pulse Modulation	478
Gate Input Polarity - Chirp Modulation	235
Gate Start	
Power Analysis	188, 339
Gate State	
Power Analysis	188, 339
Gate Stop	
Power Analysis	188
Gate view	
Power Analysis	184
Gate view - Power Analysis)	386
Gateway - Setup	101, 505, 507
Gaussian Distribution	
Noise	455
GET	271
Getting started	45
GPIO	104
Characteristics	270
interface messages	270

- Remote control interface 265
 - GPIB address 271, 505
 - GPIB bus address 105
 - GPIB bus control
 - remote 307
 - GPIB - Visa Resource String 106
 - Grid
 - Power Analysis 184, 341
 - GTL 271
- H**
- Hardcopy Data - Power Analysis 357
 - Hardcopy - Destination 113, 318
 - Hardcopy Device - Power Analysis 358
 - Hardcopy Device Size 323
 - Power Analysis 204
 - Hardcopy Device Size - Power Analysis 360
 - Hardcopy dialog - File 113
 - Hardcopy File Name 319, 320
 - Power Analysis 204
 - Hardcopy File Name - Power Analysis 361, 362
 - Hardcopy - File setup 114
 - Hardcopy Format 318, 323
 - Power Analysis 359
 - Hardcopy Path 319
 - Hardware Config 92, 313
 - Hardware options 94
 - Hostname - Setup 100
 - Hysteresis
 - Power Sensors 201
 - Hysteresis - Power Sensors 377
- I**
- Identification
 - remote 306
 - Identification mode 105, 512
 - IDN String 105
 - IdPDbsweepResAll 499
 - IFC 271, 533
 - Impedance
 - External Inputs 478
 - Impedance - EXT 419
 - Impedance – External Inputs 217, 218
 - Impedance Trigger/Gate Signal - Pulse Modulation 235
 - Import/Export
 - List Mode data 145, 447
 - Pulse Train data 261, 262
 - User Correction data 211, 213
 - Import/Export - List Mode data 143, 482
 - Import/Export - User Correction data 404
 - Import License Key 96
 - Indication 188, 194
 - Indication - Trace power analysis 176
 - INF 288
 - INFO key 65
 - Input
 - PULSE EXT 231
 - Input connector 21, 22, 24
 - Installed Assembly 93
 - Instrument Config 92, 313
 - Instrument messages 266
 - Instrument settings
 - recall 308, 331
 - save 308, 332
 - Instrument settings - recall 119
 - Instrument settings - save 118
 - Instrument Trigger 135, 142, 158, 245, 253
 - Instrument trigger input slope 420
 - Interface
 - functions (GPIB bus) 534
 - Interface Clear 533
 - Interface messages 266, 268
 - Interfaces
 - GPIB 270
 - USB 269
 - Interrupt 301
 - IP address 267
 - Changing 36
 - IP Address Mode 506
 - IP Address Mode - Setup 100
 - IP Address - Setup 101, 507
 - IST 296
 - IST flag 299
 - remote 306
- K**
- Key
 - Arrow key 20
 - BACKSPACE 20
 - CLOSE 19
 - Cursor key 20
 - DIAGRAM 18
 - ENTER 20
 - ESC 18
 - FILE 18, 117
 - FREQ 17
 - HCOPY 16
 - HELP 16
 - HIDE 19
 - INFO 16
 - INSERT 20
 - LEVEL 18
 - LOCAL 16
 - MENU 18
 - MOD ON/OFF 18, 216
 - ON/OFF 18
 - PRESET 16, 30, 89
 - REARR 19
 - RF ON/OFF 18
 - SETUP 16, 90
 - TOGGLE 18
 - WINBAR 19
 - Keyboard 110
 - Keyboard Language 324
 - Keyboard Layout 102, 324
 - Key combinations 83
 - Key - HELP 116
 - Key - LOCAL 112
 - Keypad 19
 - Keywords
 - see Mnemonics 284
- L**
- LAN
 - Configuration 35
 - Interface 267
 - IP address 267
 - Remote control interface 265
 - VISA 267

- VXI protocol 268
 - LAN Connection - Setup 109
 - Language Keyboard 324
 - Layout Keyboard 102, 324
 - Learn List Mode Data 140, 451
 - Level 150
 - Power Sensors 166
 - RF output 151, 463
 - Step width 468
 - Level control 160
 - Level display 63
 - Level display EMF 153
 - Level limit 151, 464
 - Level Noise
 - LF Output 456
 - Level offset 151, 463
 - Power Analysis 190, 352, 367, 368
 - Level Offset
 - Power Sensors 167
 - LEVEL OFFSET 528
 - Level offset state
 - Power Analysis 190, 352, 368, 369
 - Level - RF Level Marker 497
 - Level - Step width 152, 435
 - Level Sweep 153, 466
 - LevelSweep 529
 - Level Sweep
 - Sweep Step Count 157
 - Level - Uninterrupted setting 334
 - Level user correction 208
 - LF Frequency Marker
 - Active Marker 246
 - Amplitude 246
 - Amplitude Marker 246
 - Marker Polarity 246
 - State 246
 - LF generator
 - Frequency marker amplitude 427
 - LF Generator
 - Frequency 220, 223, 225, 237, 248
 - Period (Pulse Shape) 220, 223, 226, 249
 - Period (Sine Shape) 220, 223, 226, 237, 248
 - Period (Trapezoid Shape) 220, 223, 226, 249
 - Period (Triangle Shape) 220, 223, 226, 249
 - Pulse Duty Cycle 238
 - Pulse Period 237
 - Pulse Width 238
 - Shape 220, 223, 225, 237, 248
 - Trapezoid Fall 238
 - Trapezoid High 239
 - Trapezoid Period 238
 - Trapezoid Rise 238
 - Triangle Period 238
 - Triangle Rise 238
 - LF Gen Frequency 422
 - LF Gen Voltage 248, 439
 - LF Level Marker - Level Sweep 255, 433
 - LF Level Marker State - Level Sweep 255, 434
 - LF Level Sweep - Active Marker 433
 - LF output 247
 - LF Output Source 248, 425
 - LF output State 247
 - LF Output State 425
 - LF Source - Level Sweep 433
 - LF Sweep 243, 253, 423
 - LFSweep 529
 - Licence for software option 94
 - License Key 95
 - Limit
 - Level 464
 - Limit - Level 151
 - Linux 33
 - Linux controller 40
 - List mode 137, 466
 - manual processing of lists 138
 - ListMode 529
 - List Mode Data 140
 - List Range In 142, 450, 451
 - LLO 271
 - Load instrument settings 119, 308, 331
 - Local - Remote Channel Control 106
 - Local to remote switchover 272, 273
 - Lock keyboard 513
 - LOC-LLO 529
- ## M
- Malfunctions
 - reacting 303
 - Manual Remote Control 38
 - Marker
 - LF Frequency Marker 246
 - Power Analysis 202, 203
 - RF frequency marker 136
 - Marker indication
 - Power Analysis 169
 - Marker Polarity 102, 137, 159
 - Marker - RF Level Marker 159
 - Marker view
 - Power Analysis 184
 - Marker view - Power Analysis) 386
 - Mathematics - Power Analysis 178
 - Max
 - Power Analysis 180
 - MAX 288
 - Maximal deviation 225
 - FM 222
 - Maximal deviation - Chirp modulation 234, 394
 - Max - Power Analysis 355, 372, 379
 - Max Separate Frequency - Power Analysis 191, 353
 - Menu structure
 - access denied 68
 - header 68
 - menu area 68
 - Mesial Reference - Pulse Data Analysis 370, 390
 - Messages
 - commands 266
 - instrument 266
 - instrument responses 267
 - interface 266
 - Min
 - Power Analysis 180
 - MIN 288
 - Min/max - Power Analysis 356, 357
 - Min/max Y scale
 - Power Analysis 183
 - Min/max Y scale - Power Analysis 373, 374, 381
 - Min - Power Analysis 354, 371, 378
 - Min Separate Frequency - Power Analysis 191, 353
 - Mnemonics 284
 - Optional 286
 - Mode 225
 - FM 222, 411
 - IP Address 506

- Level Sweep 153, 434, 466, 497
- LF Gen 240, 250, 423
- LF Sweep 240, 250, 423, 428
- List Mode 138, 451
- PhiM 458
- RF Frequency 415
- RF frequency Sweep 130
- RF Sweep 415, 491
- Mode Import/Export
 - List Mode data 447
 - Pulse Train data 262
- Mode Import/Export - List Mode data 144, 482
- Mode Import/Export - User Correction data 212, 404
- Mode IP Address - Setup 100
- Mode - Level Sweep 440
- MOD OFF 527
- MOD ON/OFF Key 216
- Modulation
 - AM 218
 - Chirp Modulation 231
 - FM 221
 - PhiM 223
 - PM 229
 - Pulse modulation 229
- Modulation chirp - repetition frequency 234
- Modulation depth
 - PhiM 225
- Modulation depth - AM 219, 392
- Modulation deviation
 - FM 222
- Modulation deviation - Chirp 234, 394
- Modulation deviation - FM 411
- Modulation deviation - PhiM 458
- Monitoring - LF Output 247, 424
- Month Hardcopy File Name 321
- Month Hardcopy File Name - Power Analysis 363, 364
- Multiplier
 - Frequency Offset 416
- Multiplier - Frequency 126
- Multi transmitter measurements 160
- N**
 - NAN 288
 - Navigation keys 20
 - NDAC 533
 - Network Settings 99
 - Network Status 100
 - New Password - Setup 108
 - NINF 288
 - Noise
 - Bandwidth 239, 455
 - Distribution 239
 - Level Density 239
 - Level Noise 239
 - Noise Distribution 455
 - Noise Level 456
 - Noise Level (System Bandwidth) 456
 - Noise Level - Noise 239
 - Noise signal 455
 - No-load voltage (EMF) 153
 - NRFD 533
 - NRP-Z Info 97
 - NTransition 297
 - Number Hardcopy File Name 321
 - Number Hardcopy File Name - Power Analysis 364
- Number of licences 94
- Numeric values
 - Special 288
- O**
 - Offset
 - Frequency 416
 - Level 463
 - Offset - Frequency 126
 - Offset - Level 151
 - Offtime
 - Pulse Train 260, 474
 - Old password - Setup 108
 - Online help
 - Working with 77
 - Ontime
 - Pulse Train 260, 475
 - Operating concept 45
 - Operating system 33
 - Operation complete
 - remote 307
 - Operation hours 93, 314
 - Option
 - Hardware 94
 - R&S SMF-B20 22
 - R&S SMF-B81 22, 24, 25
 - R&S SMF-B83 23
 - R&S SMF-K23 25, 48
 - R&S SMF-K27 48
 - R&S SMF-K3 48, 49
 - Software 94
 - Option: expiration date 94
 - Option identification
 - remote 307
 - Options - Hardcopy 113
 - OPT String 105
 - Output
 - LF 247
 - Output buffer 296
 - Output connector 21, 22, 23, 24
 - Output Polarity – Pulse Generator 257
 - Output reference oscillator signal 148
 - OvenCold 530
 - Overlapping
 - preventing 294
 - Overlapping commands 292
- P**
 - Packing 525
 - Parallel poll register enable
 - remote 307
 - Parameters
 - Block data 290
 - Boolean 289
 - SCPI 287
 - Special numeric values 288
 - String 290
 - Text 290
 - Units 288
 - Parity 509
 - Parity - RS232 Interface 105
 - Part numbers 92
 - Paste 122
 - Path reset 310
 - PCI bus 93

- Period (Pulse Shape)
 - LF Generator 220, 223, 226, 249
 - Period (Sine Shape)
 - LF generator 220, 223, 226, 237, 248
 - Period (Trapezoid Shape)
 - LF Generator 220, 223, 226, 249
 - Period (Triangle Shape)
 - LF Generator 220, 223, 226, 249
 - Phase
 - RF output signal 457
 - Phase - RF output signal 127
 - PhiM Depth 225
 - PhiM Deviation 458
 - PhiM Mode 225
 - PhiM Source 224
 - PhiM State 224, 460
 - PM Frequency 422
 - PniM Mode 458
 - Point-to-point connection 35
 - Polarity
 - Pulse Modulation 231, 472
 - RF Frequency Marker 495
 - RF Level Marker 495
 - Polarity – External Inputs 218, 408
 - Polarity - No signal (blank) marker 335
 - Polarity - Pulse Modulation 456
 - Polarity - RF Level Marker 159
 - Power
 - List Mode 141
 - Power Meter Type - External Level Control 163
 - Power-On Count 92, 93
 - Power-On Counter 314
 - Power-On State 152, 336
 - Power Resolution - Level Settings 151, 467
 - PPC 271
 - PPE 296
 - PPE register 299
 - PPU 271
 - Prefix Hardcopy File Name 322
 - Prefix Hardcopy File Name - Power Analysis 364
 - Preset 30
 - Preset instrument settings 30
 - Preset - instrument settings 89, 310
 - Protection 106
 - Protocol
 - VXI 268
 - Proximal Reference - Pulse Data Analysis 371, 390
 - PSK Source 228, 409
 - PSK State 228, 410
 - PTRansition 297
 - Pulse Analysis State - Pulse Data Analysis 369
 - Pulse data indication
 - Power Analysis 169
 - Pulse Data Indication
 - Average Power 389
 - Distal Power 389
 - Duty Cycle 389
 - Fall Time 389
 - Mesial Power 389
 - Minimal Power 389
 - Overshoot Falling Edge 389
 - Overshoot Rising Edge 389
 - Peak Power 389
 - Proximal Power 389
 - Pulse Base Level 389
 - Pulse Off Time 389
 - Pulse Period 389
 - Pulse Start Time 389
 - Pulse Stop Time 389
 - Pulse Top Level 389
 - Pulse Width 389
 - Rise Time 389
 - Pulse Data View
 - Power Analysis 184
 - Pulse Data View - Power Analysis 387
 - Pulse Delay 256, 470
 - Pulse Duty Cycle – LF Generator 238, 436
 - Pulse External Impedance 259
 - Pulse generator 255
 - Pulse Generator
 - Pulse Train 259
 - Pulse Mode 256, 471
 - Pulse modulation 229
 - repetition frequency 256, 422, 472
 - Pulse Output State – Pulse Generator 257
 - Pulse period 256, 472
 - Chirp modulation 234
 - Pulse Period – LF Generator 237, 436, 438
 - Pulse Train 256
 - Pulse Generator 259
 - Pulse Train Data 260
 - Pulse trigger input slope 235, 258, 479
 - Pulse width 256, 483
 - Chirp modulation 234
 - Pulse Width – LF Generator 238, 436
- ## Q
- Queries 266, 292
 - Status 302
 - Question mark 290, 292
 - Quotation mark 290
- ## R
- R&S SMZ Frequency Multiplier 264
 - Rackmounting 28
 - Ratio – Amplitude Modulation 220
 - Ratio – Frequency Modulation 411
 - Ratio – Phase Modulation 459
 - Recall instrument settings 119, 120, 308, 331
 - Recall intermediate 308
 - Recall Intermediate 120
 - Recent data sets 119
 - Recommendations
 - remote control programming 303
 - Reference frequency
 - external 147, 484
 - Reference frequency adjustment mode 148, 486
 - Reference oscillator 146
 - Reference oscillator - EFC (Electronic frequency control) 148
 - Reference oscillator - output 148
 - Reference Voltage
 - External Level Control 460, 461
 - Reference Voltage - External Level Control 163
 - REF OUT output 146
 - Registers 296
 - REM-LLO 528
 - REMOTE 528
 - Remote access 38
 - Remote control
 - Basics 265
 - GPIB address 271

Interfaces	265
Protocols	265
Remote Control	
GPIB	274
Remote control switchover	272
REN	533
Rename	122, 331
Repetition	
Pulse Train	260
Reset	
List Mode	139
Reset Auto Scale	
Power Analysis	169, 184
Reset Auto Scale - Power Analysis	356, 373, 380
Reset Delta Phase Display	127, 457
Reset device parameters	310
Reset instrument settings	30, 89, 310
Reset path	310
Reset values	
remote	308
Restart Network - Setup	101
Revisions	92
RF Blanking	103
RF During Power Search - ALC	162, 334
RF frequency	126, 413
RF Frequency	48
RF frequency marker	136
RF Frequency Marker	
Active Marker	137
Amplitude	137
Amplitude Marker	136
Frequency	136
Polarity	495
RF Level Marker	
Polarity	495
RF Level Marker - Polarity	159
RF Level Marker - State	159
RF OFF	527
RF OFF mode	
attenuator settings	462
RF ON/OFF key	122, 335
RF output	
Power-on state	152
RF output level	151, 463
RF output - Power-on state	336
RF output signal	
Phase adjustment	457
RF output signal - Phase adjustment	127
RF Signal - Frequency	126
RFSweep	529
RF Sweep	
Sweep Step Count	134
Rotary knob	20
RS232 interface	105
RS232 Interface	
Baudrate	508
Parity	509
Stop bits	509
Run Update	97
S	
Sample&Hold mode	160
Save	
Power Analysis	204
Save immediate	118
Save instrument settings	118, 308, 332
Save intermediate	308
Save Options Hardcopy	
Power Analysis	204
Save to Ref - Power Analysis	177
Scan State – Amplitude Modulation	220
SCPI	
Parameters	287
Syntax	284
Version	265
SCPI compliant commands	266
SCPI - error messages	530
Screen Saver	101
Screen Saver - Setup	315
SDC	271
Search Once - ALC	162, 461
Security Password - Setup	110
Security Settings	
Accept	110
Annotation Amplitude	109
Annotation Frequency	109
Change Password	108, 109
Confirm Password	108
Display	109
Keyboard	110
LAN Connection	109
New Password	108
Old Password	108
Security Password	110
USB Device	109
User Name	107
Select ASCII Destination	
Pulse Train data	262
User Correction data	212
Select ASCII Destination - List Mode data	144
Select ASCII Source	
Pulse Train data	262
User Correction data	212
Select List	140, 453
Select NRP File	97
Select Operation - File menu	118
Select Pulse Train Data	260
Select pulse train file	477
Selftest	
remote	309
Sensor - Power Sensors	164
Sequential commands	292
Serial	
Remote control interface	265
Serial bus	93
Serial interface	105
Serial numbers	92
Serial - Visa Resource String	106
Service request (SRQ)	298, 301
Service request enable	
remote	308
Service request enable register (SRE)	298
Setting commands	266
Setting not possible	68
Setting parameters	69
Set to default	105
Setup key	90
Shape	
LF Level Sweep	253
LF Sweep	430
RF Level Sweep	157, 498
RF Sweep	492
Shape - LF Frequency Sweep	243

- Shape - LF generator 220, 223, 225, 237, 248
- Shape - LF Level Sweep 435
- Shape - RF Sweep 133
- Show level permanent - Power Sensors 166, 346
- Single Pulse 256
- Slope
 - Instrument trigger input 420
 - pulse trigger input 258, 479
- Slope - pulse trigger input 235
- Software options 94
- Source
 - External Level Control 162, 461
 - FM 222
 - Level Sweep Trigger 153, 520
 - LF output 248, 425
 - LF Sweep Trigger 240, 250, 517, 519
 - List Mode 138
 - List Mode Trigger 454
 - PhiM 224
 - Power Sensors 167
 - Pulse Modulation 230
 - Reference Oscillator 486
 - RF frequency Sweep Trigger 130
 - RF Sweep Trigger 518
- Source - AM 219, 393
- Source - ASK 227, 407
- Source - FM 412, 459
- Source - FSK 228, 408
- Source Import/Export
 - List Mode data 448
 - Pulse Train data 262
 - User Correction data 213
- Source Import/Export- Pulse Train data 483
- Source Import/Export- User Correction data 405
- Source - Power Sensors 349
- Source - PSK 228, 409
- Source - Pulse Modulation 473
- Source - Reference Oscillator 147
- Spacing
 - Level Sweep 157, 498
 - LF Sweep 430
 - Power Analysis 181
 - RF Sweep 492
- Spacing - LF Sweep 243
- Spacing - Power Analysis 354, 371, 378
- Spacing - RF Sweep 133
- Span (RF sweep) 133, 416
- SPD 271
- SPE 271
- Special characters
 - SCPI 287
- SRE 296
- SRE (service request enable register) 298
- SRQ 533
- SRQ (service request) 298, 301
- Standard View - Power Analysis 388
- Standby mode 16
- Start
 - Power Analysis 175
 - Power Sensors 342
- Start/Stop Gui Update 96, 510
- Start Freq 132, 417
 - LF Sweep 253, 423
- Start Freq - LF Sweep 243
- Start Level 156, 440, 467
- Startup complete 515
- State
 - ALC 161, 462
 - Chirp modulation 233
 - LF Frequency Marker 246
 - List Mode 138, 415
 - PhiM 224
 - Power Sensors 165
 - Pulse Modulation 230, 473
 - RF frequency marker 136
- State - Chirp modulation 233
- State - Pulse Output State 457
- State - RF Level Marker 159, 497
- State - User Correction 209
- Status
 - Queries 302
- Status byte
 - remote 305, 309
- Status Information 96
- status messages
 - ALC On 529
 - AttFixed 529
 - Auto 529
 - BUSY 528
 - EXT REF 528
 - FREQ OFFSET 527
 - LEVEL OFFSET 528
 - LevelSweep 529
 - LFSweep 529
 - ListMode 529
 - LOC-LLO 529
 - MOD OFF 527
 - OvenCold 530
 - REM-LLO 528
 - REMOTE 528
 - RF OFF 527
 - RFSweep 529
 - S&H 529
 - Table 529
 - UCorr 529
- Status registers 296
 - CONDITION 297
 - ENABLE 297
 - EVENT 297
 - model 297
 - NTRansition 297
 - parts 297
 - PTRansition 297
- Status reporting system 295
 - Application 300
 - common commands 305
- STB 296
- Step
 - Level Sweep 157, 499
 - Power Analysis 181
- Step Lin
 - LF Sweep 253, 431
 - RF Sweep 493
- Step Lin - LF Sweep 244
- Step Lin - RF Sweep 134
- Step Log
 - LF Sweep 253, 431
 - RF Sweep 494
- Step Log - LF Sweep 244
- Step Log - RF Sweep 134
- Step Log - Power Analysis 354, 371, 379
- Step width
 - Frequency 418
 - Level Sweep 157, 499

- RF Sweep 493
 - Step width - Frequency 126
 - Step width - RF Sweep 134
 - Stop bits 509
 - Stop bits - RS232 Interface 105
 - Stop Freq
 - LF Sweep 253, 424
 - RF Sweep 417
 - Stop Freq - LF Sweep 243
 - Stop Freq - RF Sweep 132
 - Stop Level 157, 441, 468
 - Storing 525
 - Subnet Mask - Setup 101, 507
 - Suffixes 286
 - Sweep
 - Center frequency 413
 - LF start frequency 253, 423
 - LF stop frequency 253, 424
 - RF frequency Sweep 130
 - RF Sweep 415, 466, 491
 - Start Level 156, 467
 - Stop Level 157, 468
 - Trigger 132, 156, 252, 521
 - Sweep - Center frequency 133
 - Sweep count - LF Level Sweep 434
 - Sweep - LF start frequency 243
 - Sweep - LF stop frequency 243
 - Sweep shape
 - LF Level Sweep 253
 - LF Sweep 430
 - RF Level Sweep 157, 498
 - RF Sweep 492
 - Sweep shape - LF Frequency Sweep 243
 - Sweep shape - LF Level Sweep 435
 - Sweep shape - RF Sweep 133
 - Sweep spacing
 - Level Sweep 157, 498
 - RF Sweep 492
 - Sweep spacing - RF Sweep 133
 - Sweep - Start Level 440
 - Sweep Step Count
 - Level Sweep 157
 - RF Sweep 134
 - Sweep - Stop Level 441
 - Sweep Time
 - Frequency Sweep 494
 - RF Sweep 134
 - Sweep - Trigger 242
 - Synchronization bandwidth – Reference oscillator 147
 - Synchronization bandwidth
 - Reference oscillator 485
 - Synchronize to internal clock
 - Pulse Modulation 231
 - Synchronize to internal clock - Pulse Modulation 473
 - Syntax elements
 - SCPI 290
 - System directory 324
 - System Settings - Setup 101
- T**
- TCPIP - Visa Resource String 106
 - Terminator recognition 505
 - Time - Setup 99
 - Timing
 - Power Analysis 181
 - Timing - Power Analysis 355, 372
 - Trace Color - Power Analysis 179, 383
 - Trace - Gate 188
 - Trace Value
 - Average Power 387
 - Distal Power 387
 - Duty Cycle 387
 - Fall Time 387
 - Mesial Power 387
 - Minimal Power 387
 - Overshoot Falling Edge 387
 - Overshoot Rising Edge 387
 - Peak Power 387
 - Proximal Power 387
 - Pulse Base Level 387
 - Pulse Off Time 387
 - Pulse Period 387
 - Pulse Start Time 387
 - Pulse Stop Time 387
 - Pulse Top Level 387
 - Pulse Width 387
 - Rise Time 387
 - Trapeze Fall - LF Output 437
 - Trapeze High - LF Output 437
 - Trapeze Rise - LF Output 438
 - Trapezoid Fall – LF Generator 238
 - Trapezoid High – LF Generator 239
 - Trapezoid Period – LF Generator 238, 437
 - Trapezoid Rise – LF Generator 238
 - Triangle Period – LF Generator 238
 - Triangle Rise – LF Generator 238
 - Trigger
 - Power Sensors 200
 - Trigger event
 - remote 309
 - Triggering sweep manually 156, 432, 488, 496
 - Trigger Input Slope 135, 142, 158, 245, 253
 - Trigger level
 - Chirp Modulation 235
 - Trigger Level
 - Input/Trigger Settings 258
 - Power Sensors 201
 - Trigger Level - Input/Trigger Settings 478
 - Trigger Level - Power Sensors 377
 - Trigger mode
 - Chirp Modulation 235
 - Trigger Mode
 - Power Sensors 201
 - Pulse Modulation 257, 479
 - Trigger - Power Sensors 378
 - Trigger Source
 - Level Sweep 153, 520
 - LF Sweep 240, 250, 517, 519
 - List Mode 138, 454
 - RF frequency Sweep 130
 - RF Sweep 518
 - Type
 - Power Sensors 165
 - Type - Power Sensors 381, 382
- U**
- UCorr 529
 - Ultr@VNC 40
 - Uninterrupted level setting 334
 - Unit
 - Power Sensors 166

Units	288
Input	19
UNIX controller	40
UP	288
Update sensor	97
Update - Setup System	98
USB	
Interfaces	269
Remote control interface	265
USB Device - Setup	109
Use as X Scale - Power Analysis	192
Use ext. level correction data	92
Use ext. loop gain correction data	92
Use ext. Loop Gain - Correction Data	312
Use Level Adjustment Data	313
User Correction	208
User Correction Data	209, 399
User Name - Setup	107
Use Sensor for RF Level Control - Power Sensors	169
Use Separate Frequency - Power Analysis	190, 353, 368, 376
Use SParameters	
Power Analysis	190
Power Sensors	169
Use SParameters - Power Sensors	345

V

V/GHz Ratio	102
Value - User Correction	209
Variation Active	126
Variation Step	126, 127, 152, 418, 435, 468
Video Polarity	
Pulse Modulation	231
Video Polarity - Pulse Modulation	471
VISA	265, 267
Libraries	266
Resource string	266, 267
Visa Resource String	106
Ethernet	507
GPIB	508
Serial	508
Socket	509
USB	508
Visible	
Power Analysis	203
VNC connection	40
Voltage	
LF output	248
Voltage / Power related - Pulse Data Analysis	369, 389
Voltage - LF output	439
VXI protocol	268

W

Wait	
remote	309
Wait Time	102
Wait Time - Setup	315
Warnings	65, 530
White space	290
Workgroup - Setup	506

Y

y-axis	
Power Analysis	183
Y-axis - Power Analysis	356, 357, 373, 374, 381
Year Hardcopy File Name	322, 323
Year Hardcopy File Name - Power Analysis	365

Z

Zero - Power Sensors	166, 189, 381
Zoom	
Pulse Train	260
Zoom Position	
Pulse Train	260